

ICD08635

# POPULAR COMMUNICATIONS

JULY 1992 \$2.95  
\$3.95 CANADA

## Boston's Shortwave Beam To The World



### **Also in this issue:**

- Scanning Oddball Bands
- Get ESM Out Of The Closet
- Scan Delay For The R-7000
- New: "Antennas 'n' Things" Column



**Plus: CB, Car Phones, Ham, Nostalgia & More!**

# Listen In With the Pros



Did you know ICOM receivers are used by local, state and federal government agencies? The professionals in these critical positions require the utmost in signal clarity, performance and reliability. ICOM's R7100 ultra high-tech receiver meets, and even exceeds, these stringent demands.

**Listen To Them All** ...on ICOM's R7100. Capture lowband, marine, aircraft, amateur, emergency— or relax with FM and television! Cover the entire 25 MHz to 2 GHz bands in 8 tuning steps: 100 Hz, 1-, 5-, 10-, 12.5-, 20-, 25- and 100-kHz, and 1 MHz.

**900 Memory Channels.** 9 bands of 100 channels each let you group and access all your favorite frequencies automatically.

**All Mode Scan.** Super fast scanning in Programmed Scan, Selected Memory and Window Scan— flexibility never before realized.



**Auto Memory Write Scan** automatically records busy frequencies for later monitoring.

**Loud and Clear With DDS.**

Direct Digital Synthesis means an extremely low carrier-to-noise ratio for the ultimate in receiver performance. Compare it and hear the difference!

**Dual Windows.** Scan in one window, tune in the other— like two receivers in one!

**The Most Important Feature.**

Designed and backed by ICOM. Our reputation for quality, reliability and service is unsurpassed in the communications industry. The pros don't settle for anything less. Neither should you.

*For more information, see your ICOM dealer or call our Brochure Hotline 1-800-999-9877.*

ICOM America, Inc., 2380-116th Ave. N.E.

Bellevue, Washington 98004

Customer Service Hotline (206) 454-7619

All stated specifications are subject to change without notice or obligation. All ICOM radios significantly exceed FCC regulations limiting spurious emissions. R7100392



## IC-R1

Put the whole world in your pocket.

Only 4" high!



**BUY ANY R7100,  
GET A TINY R1  
AT A TINY PRICE!**  
Special limited time offer.  
See Icom Dealer for details.



# ICOM

Simply the Best®

EEB

# RECESSION BREAKING SALE

THESE SALES PRICES ARE ONLY GUARANTEED TILL JUNE 30, 1992 HURRY CALL NOW!

**TCM38V SONY TAPE RECORDER**  
JUST REDUCED 20%  
\*Turns your scanner into a logger  
\*Record all the action, listen later  
\*Date, time index digitally recorded  
\*Ext audio or built-in Mic. Auto start ON/OFF  
\*Only 3.5x5.25x1.25 in., 10oz. (2)AA not incl.)



**\$79.95**

**M75 & M100**  
LOW NOISE PRE-AMP  
UP TO 25% OFF

\*Improve your scanner sensitivity  
\*25-2100MHz  
\*Gain adj. -6 to 20dB  
\*3 switchable BW filters  
\*9V batt. or Opt PA12P AC adpt. \$9.95  
\*BNC (f) in, BNC (M) out  
M75 was \$119.95 NOW \$99.95



M100 for Tranceivers to 5 Watts  
Same specs as M75, Auto Switch over  
M100 was \$159.95 NOW \$119.95

**Sony's Newest**  
BACK IN STOCK!  
THE ICFSW77

World's most sophisticated portable AM/FM/SWL receiver, 160 memory, Station name tuning, synchro detection, CW-SSB!  
10.8x6.8x1.8in 52oz.



LIST \$629.95  
**\$499.95** +SH

**SONY ICFSW55**

in HI TECH  
bles, 125 memories,  
on name tuning, Full  
AM, FM coverage,  
-SSB, Tune100Hz  
ps. LIST \$449.95



EEB **\$369.95** +SH

**ICOM SIMPLY THE BEST**  
NEW R7100 25-2000MHz NEW  
900 Memories AM/FM/FMW/CW/SSB  
Clock, recorder Control, many specs same as R7000. Only 9.5x3.7x9.4in 13 lbs.



ICOM List \$1383 EEB **\$1149** +SH

ICR7000 List \$1199 EEB **\$1019** +SH  
ICR71A List \$ 999 EEB **\$ 849.95** +SH  
ICR72A List \$972 EEB **\$819.95** +SH  
ICR9000 List \$5677 EEB **\$4795** +SH  
ICR100 List \$ 707 EEB **\$ 599** +SH

## ICOM R1

JUST REDUCED ANOTHER \$90.00  
ICOM R1 World's smallest scanner!



.1 to 1300MHz, no gaps  
AM, FM, FMW,  
100 memories.  
Only 1.9x4.0x1.4 9.9 ozs.  
Listen to shortwave  
local AM/FM, Police,  
Airband, Amateurs, TV  
sound, ALL 800 MHz!

The World of Radio in Your Hand!  
ICOM LIST WAS \$625  
NOW EEB Priced at only **\$449.95**

## AOR SCANNERS

AR1000 .5-1300MHz  
1000 memories, search  
40/sec. AM/FM/FMW  
Key Pad or manual tuning  
4 AA Nicad, charger, DC  
Lig. Plug, case, belt clip,  
ear phone included!



6.7x2.6x1.4 15oz  
Advertised at \$499  
EEB **\$419.95** +SH

FREE  
EEB  
1992

CATALOG

\$1 CANADA  
\$3 ELSEWHERE  
- CALL -  
- FAX -  
- WRITE -  
TODAY  
FOR  
YOUR  
COPY!

OVER 90 PAGES  
SWL-SCANNER  
AMATEUR INTER  
DISCOUNT PRIC

REALISTIC SCANNERS  
DISCOUNT PRICES

PRO2006 HYPERSCAN  
"THE BEST SCANNER UNDER \$800"

\*25-520/760-1300MHz\*  
\*SIMPLE MOD  
RESTORES  
CELLULAR INCL  
\*400 MEMORIES  
(10 BANKS)  
\*SCAN 26CH/SEC.  
\*120VAC & 13.8VDC



LIST \$399.95 EEB **\$369.95** +SH

PRO37 NEW HYPERSCAN

\*200 MEMORY  
\*SCAN 26CH/SEC.  
\*COVERS ALL 800 MHz  
EXCEPT CELLULAR

LIST \$299.95 EEB **\$259.95** +SH

DRAKE R8  
FREE DUST COVER



Full HF coverage .1-30MHz  
100memory ch, excellent  
Filters, Keyboard or Manual  
entry, Multi Voltage Power.

EEB Price  
NOW **\$969.00** +SH

AR3000A  
Upgraded AR3000  
New CPU .1-2036MHz  
400 mem, scan 50ch/sec  
13.8VDC .5A AC adpt  
included!



LIST \$1095  
EEB **\$995** +SH

THE ULTIMATE COMPACT SCANNER

FAIRMATE  
HP2000

From the makers of AR1000XC  
HP2000 is identical to AR1000XC  
Comes with 2 antennas!  
List was \$449.00



THIS SALE ONLY **\$379.95** +SH

\*Sorry No CODs  
\*FREE Catalog in U.S.  
\*Battery's not included  
\*Prices subject to change  
\*Prices do not include freight  
\*Returns subject to 20% restock fee

EEB

ELECTRONIC EQUIPMENT BANK  
323 Mill Street N.E.  
Vienna, VA 22180

ORDERS: 800-368-3270  
Local Tech: 703-938-3350  
FAX: 703-938-6911

# POPULAR COMMUNICATIONS

JULY 1992

VOLUME 10, NUMBER 11

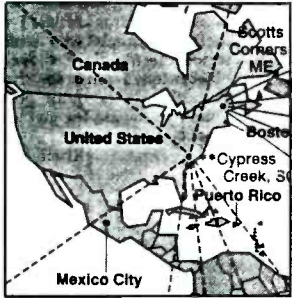

9

## FEATURES

### Beamed From Boston: Monitor Power 9

One of America's Shortwave Voices  
By Gerry L. Dexter

### Scanning The Oddball Bands 12

Search For Scanner Intrigue In The Overlooked Bands. You're Missing Plenty!  
By Chuck Robertson

### Radio: The Way It Was 14

A Look Back Into The Golden Era, & Earlier!  
By Alice Brannigan

### Books You'll Like 22

Listen In On NASA, Something For The Engineer, and What Can You Get For That Old TV?  
By R. L. Slattery

### Get ESM Out Of The Closet 24

Electronic Support Measures: What Do You Know About Them?  
By William R. Bigas

### Scan Delay For The R-7000 29

It Is A Simple Addition To This Worthwhile Receiver  
By Ronald M. Vaculke, W9SEK

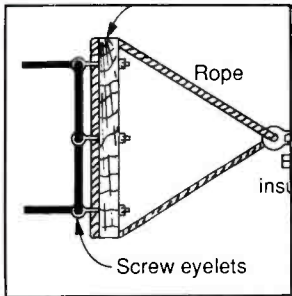

48

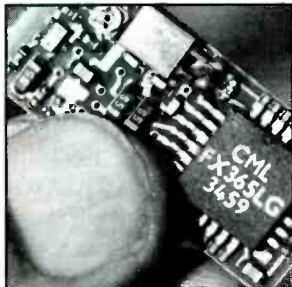

62

## COLUMNS

How I Got Started . . . . .	31
Scanning VHF/UHF . . . . .	32
Satellite View . . . . .	34
Telephones Enroute . . . . .	36
You Should Know . . . . .	38
RTTY . . . . .	42
Ham Column . . . . .	47
Antennas 'n' Things . . . . .	48
Broadcast DXing . . . . .	50
Pirates Den . . . . .	57
CB Scene . . . . .	58
Clandestine Communique . . . . .	61
Emergency . . . . .	62
Communications Confidential . . . . .	64
Washington Pulse . . . . .	68
Listening Post . . . . .	71

## DEPARTMENTS

Beaming In . . . . .	4
Mailbag . . . . .	6
Worldband Tuning Tips . . . . .	40
New Products . . . . .	54
Communications Shop . . . . .	78

**This month's cover:** Control room at WSHB shortwave station of the World Service of the Christian Science Monitor. Transmitter is at Cypress Creek, SC. Photo by Larry Mulvehill.



14

## EDITORIAL STAFF

**Tom Knettel, K2AES/KNY2AB**, Editor  
**Jeanine M. O'Connor**, Associate Editor

## CONTRIBUTING EDITORS

**Gerry L. Dexter**, Shortwave Broadcast  
**Robert Margolis**, RTTY Monitoring  
**Gordon West, WB6NOA**, Emergency  
**Don Schimmel**, Utility Communications  
**Edward Teach**, Alternative Radio  
**Harold A. Ort, Jr.**, Military Consultant  
**Janice Lee**, Radar Detectors  
**Chuck Gysl, N2DUP**, Scanners  
**Roger Sterckx**, AM/FM Broadcasts  
**Harry Helms, AA6FW**, Thoughts and Ideas  
**Donald Dickerson, N9CUE**, Satellites  
**Kirk Kleinschmidt, NT0Z**, Amateur Radio

## BUSINESS STAFF

**Richard A. Ross, K2MGA**, Publisher  
**Donald R. Allen, N9ALK**, Advertising Mgr.  
**Emily Kreutz**, Sales Assistant  
**Dorothy Kehrwieler**, General Manager  
**Frank V. Fuzia**, Controller  
**Catherine Ross**, Circulation Director  
**Melissa Kehrwieler**, Data Processing  
**Carol Minervini**, Data Processing  
**Denise Pyne**, Customer Service

## PRODUCTION STAFF

**Elizabeth Ryan**, Art Director  
**Barbara Terzo**, Assistant Art Director  
**Susan Reale**, Artist  
**Dorothy Kehrwieler**, Production Manager  
**Emily Kreutz**, Production  
**Pat Le Blanc**, Phototypographer  
**Florence V. Martin**, Phototypographer  
**Hal Keith**, Technical Illustrator  
**Larry Mulvehill, WB2ZPI**, Photographer

A publication of

 CQ Communications, Inc.  
76 North Broadway  
Hicksville, NY 11801-2953 USA.

Offices: 76 North Broadway, Hicksville, NY 11801. Telephone 516 681-2922. FAX (516) 681-2926. Popular Communications (ISSN 0733-3315) is published monthly by CQ Communications, Inc. Second class postage paid at Hicksville, NY and additional offices. Subscription prices: Domestic—one year \$19.95, two years \$38.00, three years \$57.00. Canada/Mexico—one year \$22.00, two years \$42.00, three years \$63.00. Foreign—one year \$24.00, two years \$46.00, three years \$69.00. Foreign Air Mail—one year \$77.00, two years \$152.00, three years \$228.00.

U.S. Government Agencies: Subscriptions to Popular Communications are available to agencies of the United States government, including military services, only on a cash with order basis. Requests for quotations, bids, contracts, etc. will be refused and will not be returned or processed.

Entire contents copyright ©1992 by CQ Communications, Inc. Popular Communications assumes no responsibility for unsolicited manuscripts, photographs, or drawings. Allow six weeks for change of address or delivery of first issue. Printed in the United States of America.

Postmaster: Please send change of address to Popular Communications, 76 North Broadway, Hicksville, NY 11801.

# MONITOR MORE WITH ADVANCED EQUIPMENT FROM UNIVERSAL!

## COMMUNICATIONS RECEIVERS

### Japan Radio NRD-535D



Triple conversion power with ECSS, Bandwidth Control and 3 filters included. Now with the improved BWC. .... **\$1699.00 (+\$16)**

### Japan Radio NRD-525

Rated five stars and *Editor's Choice* by Larry Magne in *Passport '91*. .... **\$999.00 (+\$15)**

### Drake R-8

A state-of-the-art receiver for the 90's. Five bandwidths, Syncro, etc. .... **\$959.95 (+\$11)**

### Kenwood R-5000

A powerful receiver for the serious DXer. An exceptional value. .... **\$879.95 (+\$12)**

### Kenwood R-2000

Many features: mems., scan, sweep, FM mode, 24 hr. clock etc. .... **\$649.95 (+\$10)**

## PORTABLE RECEIVERS

### Panasonic RFB-45



Keypad, 18 memories, scan and search functions, S.S.B., fine tuning knob, clock-timer, S-METER, etc. .... **\$169.95 (+\$6)**

### Sony ICF-2010

Super high performance and features. VHF air too. .... **\$359.95 (+\$6)**

### Sangean ATS-818CS

Finally, a quality digital receiver with cassette, 45 mems., SSB. .... **\$249.95 (+\$7)**

### Grundig Satellit 500

Hi-tech with beautiful fidelity and style. Synchronous tuning. .... **\$399.95 (+\$6)**

*Note: Radios listed above are all LW-MW-SW-FM digital. Contact us for other models.*

## SPECIAL RECEIVERS

### Icom R-9000



Solid all-mode coverage from .1 to 1999.8 MHz. Multi-function CRT with spectrum analyzer. The ultimate receiver! .... **\$4695.00 (+\$30)**

## SHORTWAVE ANTENNAS

### Alpha Delta DX-SWL Sloper

MW +120-13 meter bands (60').. **\$67.95 (+\$5)**

### Alpha Delta DX-SWL Sloper-Short

90-13 meter bands (40') .. **\$57.95 (+\$5)**

### Eavesdropper Specify twin lead or coax type

9 SW bands (60-10 meters) .. **\$74.95 (+\$5)**

### McKay Dymek DA100D Active Antenna

The Cadillac of active antennas! **\$179.95 (+\$5)**

### B&W ASW-90 Full Coverage Dipole

Covers 3.5-30 MHz solid! .... **\$89.95 (+\$6)**

*Note: Many other shortwave, amateur and scanner antennas available in our catalog.*

## MULTI-MODE CONVERTERS

### Universal M-8000



If you are only *listening* to your shortwave radio you are missing half the fun. With the addition of a Universal decoder and monitor you can *see* the world. The shortwave spectrum is filled with interesting text messages and photos that you can intercept and display. If this sounds interesting to you, request our two free pamphlets: *Listening to Radioteletype and Receiving FAX on Your Shortwave Radio*. Shown above is the new Universal M-8000 which decodes modes not previously available. Contact us today for information on the full line of Universal decoders.

### You can monitor:

- ◆ Coastal Station Traffic
- ◆ Ship Telexes
- ◆ Press Reports
- ◆ Press Photos
- ◆ Satellite Photos
- ◆ Weather Maps
- ◆ Unclass. Military Traffic
- ◆ Diplomatic Traffic
- ◆ Ham Messages
- ◆ Weather Reports
- ◆ Research Traffic
- ◆ Packet Messages
- ◆ Radio Bulletins

### Universal M-1000

Turn your IBM computer (or compatible) into a powerful intercept device! The Universal M-1000 Decoder Card requires just one full-size slot in your PC. Your computer can open up a new world of listening (... or *seeing*) opportunities! Standard reception modes are included such as Morse Code, Baudot RTTY and Sitor A/B. Advanced diplo.-military modes such as ARQ-M2, ARQ-E and ARQ-E3 are supported plus ASCII and Packet. Advanced RTTY enthusiasts will appreciate the *Databit* and *Literal* modes, helpful in protocol identification and decryption. The video quality of your FAX intercepts will amaze you. Advanced FAX imaging includes false-color and zoom features. FAX images as well as text traffic can be saved on to disk. Operation is easy through on-screen menus, status indicators and help windows. A new *datascope* feature operates in both RTTY and FAX modes. This device merely requires audio from your receiver. The M-1000 comes with an informative manual and software on both 3½" and 5¼" disks. Upgradable for future optional codes. Six month limited warranty. Made in the U.S.A. **Write for Information. \$399.95 (+\$5)**



## COMMUNICATIONS BOOKS

### Passport To Worldband Radio

By *L. Magne*. Graphic presentation of all SWBC stations. Equipment reviews too. .... **\$16.95**

### Shortwave Receivers Past & Present

By *F. Osierman*. Your guide to 200 receivers with new-used value, specs, features. .... **\$8.95**

### Aeronautical Communications Handbook

By *R. Evans*. A mammoth book on all aspects of shortwave aero listening. 266 pages. .... **\$19.95**

### Complete SWL's Handbook Third Edition

By *Bennett, Helms, Hardy*. Nearly 300 pages on all aspects of SWL'ing. .... **\$16.95**

### Guide To Utility Stations

By *J. Kligenfuss*. The definitive guide to utility stations- CW, SSB, FAX and RTTY.. .... **\$34.95**

### Easy-Up Antennas for Listeners & Hams

By *E. Noll*. Low cost, easy to erect antennas for LW, MW, FM, SW, SCAN and HAM. .... **\$16.95**

### World Radio TV Handbook

All SWBC stations by country with schedules, addresses, power, etc. Reviews too. .... **\$19.95**

✓ Please add \$1 per title for shipping.

## COMMUNICATIONS CATALOG

Universal now offers a new combined communications catalog covering shortwave, amateur and scanner equipment. There is also an unbeatable selection of antennas, books, parts and accessories. This **HUGE 100 PAGE** (8½" by 11") publication covers everything for the radio enthusiast. With prices, photos and full descriptions.

Available **FREE** by fourth class mail or \$1.00 by first class mail.

- Universal ships worldwide.
- Prices and specifications are subject to change.

- Universal in business since 1942.
- Visa, Master & Discover Card.
- Used equipment list available.

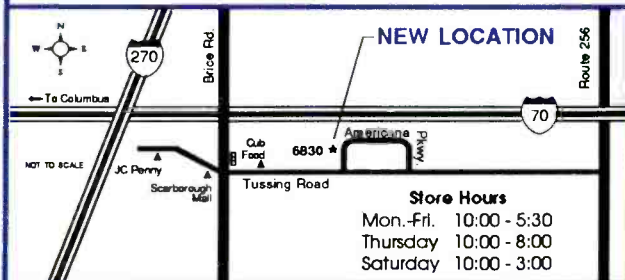

**universal radio inc.**

**Universal Radio, Inc.**  
6830 Americana Pkwy.  
Reynoldsburg, Ohio  
43068 U.S.A.

800 431-3939 Orders  
614 866-4267 Information  
614 866-2339 Facsimile

# GILFER — first in Shortwave

NRD-535D

Improved Variable Bandwidth Control



All the features: gen. coverage, 0.1 to 30 MHz in AM, USB, LSB, CW, RTTY, FAX, and Narrow FM. *Tunes to 1 Hz* with direct digital synthesis. **Advanced ECSS operation** for phase-lock AM. Variable bandwidth control. 200 memory ch. with scan and sweep. Triple superhet circuit. Superior sensitivity, selectivity, and image rejection. Dual width noise blanker, notch filter, 24 hr. clock/timer, fluorescent display, digital S meter, Squelch, RF Gain, Attenuator, A/C & Tone controls. Optional RTTY demod. **Most comprehensive computer interface.**

VISIT GILFER'S STORE  
Easy to find, accessible  
from New York City.

Take Garden State Park-  
way (NE portion of N.J.),  
Exit 172. Gilfer is in the  
center of Park Ridge,  
opposite the Borough  
Hall. Store hours:  
M-F 10am-5pm,  
Sat. 10am-3pm.

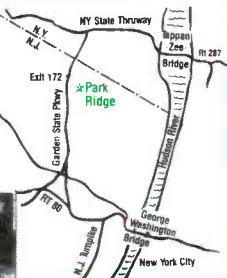

Order operators: 1-800-GILFER-1  
(1-800-445-3371) NJ 201/391-7887

**GILFER SHORTWAVE**  
52 Park Ave. • Park Ridge, NJ 07656

CIRCLE 14 ON READER SERVICE CARD

## NOW—NO CODE!

**The Ham Radio Handbook** by Don Stoner gets rave reviews as the best training aid to help you earn the no-code ham license. Over 200 pages, packed with information—all the test questions, correct answers and the theory behind the questions. Only \$9.95 (\$2.00 S&H).

## YOU CAN PASS THE CODELESS HAM RADIO TEST AND WE GUARANTEE IT!

It's easy and fun with the **NARA Education Package**. You get Don Stoner's *Ham Radio Handbook*, IBM or Macintosh compatible software to test your knowledge after you have studied the book; an extensive list of Volunteer Examiners you can contact, the *FCC Rules and Regulations* for ham radio, a copy of *Amateur Radio King of Hobbies*, plus a bonus copy of our journal, *The Amateur Radio Communicator*, by mail. The **NARA Education Package** is only \$29.95 for the IBM or \$49.95 for the Mac version (\$3.00 S&H).

**Join NARA today** and enjoy the exciting world of ham radio — and beginners don't need to know the code! A one-year **NARA** membership & subscription to *The Amateur Radio Communicator* is only \$10.00.

**NARA**  
NATIONAL AMATEUR RADIO ASSOCIATION

CALL US  
TODAY!!

P.O. Box 598, Redmond, WA 98073  
Orders Only 1-800-GOT-2-HAM  
Inquiries (206) 869-8052

CIRCLE 16 ON READER SERVICE CARD

# BEAMING IN

BY TOM KNEITEL, K2AES

## AN EDITORIAL

### Congress Working For Scanner Owners — Not!

What with this being a major election year, it's somewhat focused my thoughts on Washington's doings. Readers are kind enough not to allow me to forget, anyway. After our March issue editorial on cellular industry efforts to force additional restrictive monitoring through the Congressional mill (H.R. 1674 and S. 1132, which were tacked on to the FCC's 1992 operating budget), quite a few readers sent me copies of letters that they had received from their Congressional reps responding to inquiries about such matters.

For example, Paul T. Westervelt, III, of Chapel Hill, North Carolina, had received a letter in February from Rep. David Price, of North Carolina. Price's letter read (in part): "The House passed H.R. 1674 by voice vote on September 24, 1991. No amendments to the bill were offered during floor debate. The Senate version of this bill, S. 1132 is currently before the Senate Committee on Commerce, Science, and Transportation; no hearings have been held at this time. In response to your concerns about Section 8 of the bill, Interception of Cellular Telecommunications, I contacted the House Energy and Commerce Subcommittee on Telecommunications and Finance. According to the subcommittee staff, the intent of Section 8 is to restrict only the availability of telecommunications equipment which is designed specifically for individuals to intercept cellular phone conversations. As I understand it, the subcommittee is not attempting to restrict access to all cellular-capable scanners and receiving equipment. The subcommittee has crafted the language with this understanding and that the commission may grant exemptions for certain classes of scanning equipment."

So much for Section 8 of H.R. 1674. That letter was factual, but nevertheless it was artfully worded about the intent of H.R. 1674. It managed to fudge on stating the whole story, thus it didn't end up breaking any bad news to Paul. In a January letter to POP-COMM reader Dan Hull, of Flint, Mich., from Sen. Carl Levin, of Mich., we get a totally different perspective on H.R. 1674.

Levin's letter stated (in part): "Section 9 of the House of Representative's version of the FCC authorization bill would prohibit the manufacture of scanning radio receivers which include cellular frequencies." He went on to observe that, "The Senate's version of this legislation, S. 1132, contains no manufacturing prohibition on radio scanners.

S. 1132 has been referred to the Senate Commerce Committee for further consideration."

Live and learn. The first thing that strikes me is that there seems to be reason to believe that at least some of the legislation that gets voted into law is little understood by those sent to Washington to represent our interests. Furthermore, those whose job it is to explain things to our Congressional reps are equally uninformed and/or confused. There is also some possibility that when voters ask for answers, they could be getting a rich mixture of double-talk, fertilizer, and half-information intended to say nothing much while simultaneously lulling them into a state of contentment when, in fact, they are being rolled off to Baghdad in a barrel.

Congress consists of 100 U.S. Senators, and 435 members of the House of Representatives. Theoretically, it's a dynamic legislative concept with an enormous potential for the nation. Some members are truly great at handling their responsibilities. But there aren't enough of them. Others are only mediocre, but even that's OK. It's all too obvious that, in addition, Congress has more than its share of people who truly have no business being there.

Last March, one incumbent U.S. Senator gave up his efforts to be re-elected after a Seattle newspaper broke a story alleging 20 years worth of abusive misconduct, physical assaults, drugging, and sexual harassment of eight women who worked for him. He is only one of the members of this elite corps of Washington legislators whose alleged sleazy moral fiber has made horror headlines in recent times. According to media and court reports, influence peddling, drunkenness, drug use, tacky business dealings and associates, questionable campaign finances, abuses of power, and an assortment of bizarre personal conduct excesses, have long plagued many of these people. It raises questions regarding if, as a group, these people have the right stuff to establish reasonable and fair laws for a nation to follow.

Keep in mind that House of Representatives bank that was operated until last October for the use of members. Remember the *Rubergate* flap when it was revealed last winter that during the 39-month period prior to last October, 296 of the 435 present members of the House passed 20,000 fraudulent checks drawn on this bank? The bank had to cover the payments for \$11-million worth of these

(Continued on page 75)

# AEA is the...

## Shortwave Solution

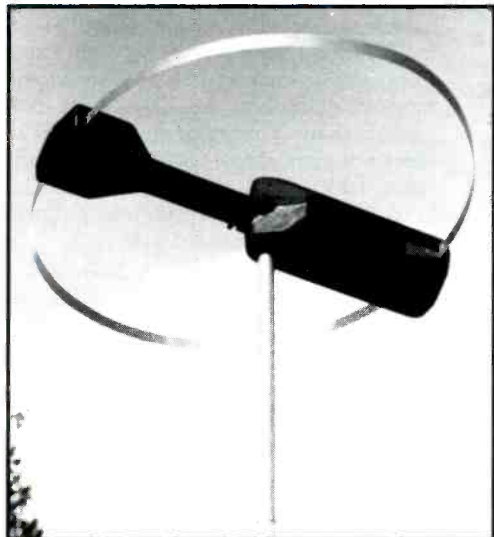

The **IsoLoop 10-30 HF antenna** is designed to work in limited space applications — apartments, condos, etc. Don't be deceived by its compact size (43" diameter) — it really works! Features include: Continuous coverage from 10 to 30 MHz; narrow bandwidth to suppress out-of-band signals; comes fully assembled (no mechanical joints); much more.

For complete information on these or any other AEA products, call the toll-free InfoLine at (800)432-8873.



**Advanced Electronic Applications, Inc.**

P.O. Box C2160 Lynnwood, WA 98036  
Tech. Support/Sales (206)775-7373  
Upgrade Line (206)774-1722  
FAX (206)775-2340  
CompuServe I.D. 76702,1013

Hayes® Hayes Microcomputer Products.  
Hercules™ Hercules Computer Technology, Inc.  
Commodore 64 and 128® Commodore  
Business Machines. Macintosh® Apple  
Computer Inc. Epson® Seiko Epson Corp.



The **PK-232MBX** is a must for the digital Shortwave Listener. By far the most popular multi-mode controller ever, it can receive seven different types of data signals including Morse code, Baudot, ASCII, TDM (Time Division Multiplex), WEFAX, NAVTEX and Packet. It also features: The indispensable SIAM which automatically identifies many types of digital signals; superior software support for PC compatible, Macintosh and Commodore 64 and 128 computers.



**AEA-FAX** is simply the best way to demodulate multi-level grey scale fax images received by your general coverage receiver. All necessary hardware and software is included in the package which also features: On-screen tuning "scope"; Autolist feature for unattended image capture and save-to-disk; "Daisy-chain" external RS-232 input allows AEA-FAX to share a COM port with a PK-232MBX or other Hayes-compatible device; up to 16 grey levels (VGA); also supports EGA, CGA and Hercules formats; prints to HP LaserJet or Epson compatible printers.

# MAILBAG

## LETTERS TO THE EDITOR

Each month we select representative reader letters for our Mailbag column. We reserve the right to condense lengthy letters for space reasons. All letters submitted for consideration must be signed and show a return address. Upon request, we will withhold sender's name should the letter be used in Mailbag. Address letters to Tom Kneitel, Editor, Popular Communications Magazine, 76 North Broadway, Hicksville, NY 11801.

### Railroad Scanning Author

Thanks to R.L. Slattery for the review and the good things written in the March issue about my railroad scanning booklet. I hope that POP'COMM readers discover the fun of listening to railroad operations. Your services to the scanning world are appreciated. Railroad fans just getting into scanning ask me about a magazine that will give them give them additional info, and I tell them about POP'COMM.

Vince Reh,  
Byron, NY

### He's On Strike

I'm concerned about something, since I use my handheld scanner out of doors in all kinds of weather. What I'm worried about is what will happen to my scanner if it should take a lightning strike while I am using it, and if there is some accessory I should get to protect the scanner.

M.W.B.,  
Columbus, GA

*Nothing to be too concerned about. If lightning scores a direct hit on your handheld scanner while you're holding the thing, you'll never have another worry in this world.*  
—Editor.

### Forbidden Knowledge

I was flipping through the February issue of *Popular Communications* (which was the first one I had ever seen) when my eye caught an ad for a book, *How To Get Anything on Anybody, Book II*. I was really enjoying the magazine until I saw the ad and a review for this book. The subject matter of your magazine generally seems to be fascinating. Undoubtedly, the information in *How to Get*

*Anything on Anybody, Book II* would also be quite interesting to your readers, but for all the wrong reasons. Don't you realize that the the material in this book is going to be used to victimize people? What else could it be used for? There is a big difference between monitoring things meant to be monitored and monitoring people's private lives. A line must be drawn here. Your magazine is called *Popular Communications*, not *Personal Surveillance*, which Mr. Lapin encourages in his book. This is just a heap of temptation for an already criminally minded public.

Jason Shutt,  
Dallas, TX

*We thank Mr. Shutt for being able to establish reasonable goals and purposes for us after seeing only one issue. Still, we have marched to the beat of a different drummer going on ten years now. At this point it's probably way too late for us get into step with Mr. Shutt's noble hopes.* —Editor.

### CB or No CB

I thumbed through several magazines about electronics and radio at a local newsstand. I couldn't believe that there were no magazines on my newsstand devoted to CB radio. The only coverage beyond a passing mention was in your magazine, and the space you devote to the topic is a far cry from being an entire magazine. Why bother at all? Obviously, in your opinion, CB'ers are not as worthy as hams, SWL's, and scanner owners. Please send me the names and addresses of any magazines completely devoted to CB radio.

Leon Griffin III,  
Lakeport, NH

*Hate to be the bearer of bad news, Leon, but in 1982 the last two national magazines devoted to CB radio died of apathy. A few years before that, there were more than forty monthly CB magazines. Our magazine is the only one that presently gives the topic any monthly coverage at all. The amount of space any topic receives in our pages is proportionately based upon the interests of our readers, according to the mail we receive. It isn't a case of CB'ers being less "worthy" than other readers. While we realize that our coverage is a "far cry" from being the entire magazine, we feel CB nevertheless deserves regular attention. We don't agree that by not bothering with CB coverage, we would improve the plight of CB operators. Our impression is that CB SCENE has a loyal following. If a sufficient number of other CB'ers agreed with you that unless we turned over the entire magazine to CB, there's no point in bothering with CB at all, then we'd consider ending our CB coverage.* —Editor.



## MICRO-CHOKE™ grabs those 800MHz signals you've been missing.

Antenna Specialists all-band scanner antennas, with our exclusive MICRO-CHOKE, offer pinpoint resonance at 800MHz and excellent performance from 25 to 1000MHz. Now—base or mobile—all police, fire, emergency and other FM communications (even portables) are within earshot. Start hearing more by sending for the FREE 16-page A/S Personal Communications Antennas catalog today!

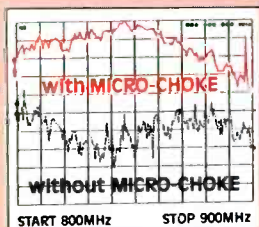

Tenfold signal improvement at 800 MHz!



MON-53 Mobile Roof/Deck-Mount Antenna



MON-52 Mobile Trunk Lid Mount Antenna



MON-58 Base Station Antenna

### the antenna specialists co.

30500 Bruce Industrial Parkway • Cleveland, OH 44139-3996  
TEL: 216/349-8400 • FAX: 216/349-8407

© Copyright 1990 by The Antenna Specialists Co.

a member of The Allen Group Inc.



® "Stripes of Quality"



**Now, You Can Eavesdrop On The World.** Introducing the new Drake R8 Communications Receiver. It's world class, world band radio, made in the U.S.A. From Perth to the Persian Gulf, Moscow to Mozambique, local or global, you hear events *as they happen* with amazing clarity. Since 1943, Drake



has been setting the standards in electronic communications . . . and then raising them. Today, there's no better shortwave receiver than the Drake R8. **Out-Of-This-World Performance.** The new Drake R8 has more standard features than other shortwave radios. You get wide frequency range (100 KHz to 30,000 KHz), coverage of all world and local bands, and excellent dynamic range. But you also get important features you won't find on receivers costing hundreds of dollars more. A multi-voltage power supply. Pre-amp and attenuator. Five bandwidth filters and synchronous detector. Dual mode noise blanker and passband offset. Non-volatile 100 channel memory. All designed to give you the best reception with the least distortion. **Down-To-Earth Design.** The ergonomic design of the R8 gives you real ease of operation. You have convenient keypad entry, with large, legible controls. The face is bold. Uncluttered. And the liquid crystal display (LCD) is backlit for easy reading. **Try The R8 . . . At Our Risk.** If you're not impressed by Drake's quality, performance and ease of operation, return the R8 Receiver within 15 days and we'll refund your money in full, less our original shipping charge. For more information, or to order, call **TOLL-FREE, 1-800-9-DRAKE-8.** Telephone orders may be placed on a major credit card. \$979.00 (Shipping and handling \$10 in continental U.S. Ohio residents add 6½% tax.) Call **TOLL-FREE, 1-800-9-DRAKE-8** today. You can't lose.

**DRAKE**

*In touch with the world.*

R.L. Drake Company • P.O. Box 3006 • Miamisburg, Ohio 45342 U.S.A.

CIRCLE 50 ON READER SERVICE CARD

"The Largest Dealer of Scanners in the World"

# SCANNER WORLD, USA®

10 New Scotland Ave., Albany, NY 12208 • 518/436-9606



## SCANNER WORLD EXCLUSIVE UNIDEN BEARCAT BC205XLT

**\$239.99** (\$8.00 shipping)

Digital programmable 200 channel hand held scanner with raised button keyboard for easy programming of the following frequency ranges: 29-54 MHz, 118-174 MHz, 406-512 MHz, 806-956 MHz. \* Features include: Scan delay, memory backup, key pad lock, sidelit liquid crystal display, channel lockout, 10 priority channels, direct channel access, automatic search, full one year factory warranty, 10 priority channels, Ni-Cad battery pack, AC adapter/charger, flexible rubber antenna carry case are all included. Size is 2-11/16" Wx1-3/8" Dx7-1/2" high. (Optional extended 2 yr. warranty \$29.99, 3 yr. extended warranty \$39.99.) (\* Excludes Cellular)

#CC-008 Heavy Duty Leather Carry Case \$27.99

## RELM RH-256NB HIGH BAND TWO-WAY RADIO



**\$339.99**  
SPECIAL PACKAGE DEAL

(Plus \$9.00 Shipping Each)

16 channel digital readout two-way radio. Covers high band frequency range of 148-162 MHz without retuning. Perfect two-way radio for ambulance, police, fire, tow trucks, taxis, commercial companies who use this band. Features include CTCSS tones built-in, priority, 25 watts output, channel scanning, back lighted keyboard, message light, time out timer, scan delay, external speaker jack. Size is 2 1/4" Hx6 1/2" Wx10 1/4" D.

SPECIAL PACKAGE DEAL includes RH-256NB, mobile microphone, 1/4 wave body mount antenna, mobile mounting bracket and mobile power cord all for the low price of \$339.99

## SPECIAL!! LOWEST PRICE EVER FOR A PROGRAMMABLE SCANNER



SR-901  
AVAILABLE ONLY  
FROM SCANNER  
WORLD

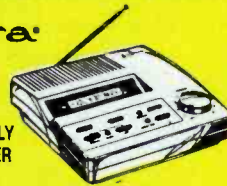

**ONLY! \$74.99** Each

(Plus \$6.00 Shipping Each)

**\$69.99** (2 or more)

Features include: 10 programmable channels, one touch memory programming, external speaker jack, 29-54 MHz, 136-174 MHz, 400-512 MHz, squelch, lockout, full frequency digital readout, AC or DC operation, retains memory up to 3 days without power, scan button. Includes AC adapter, telescopic antenna, and complete operating instructions. Size: 7 1/4" W x 2" H x 7 1/4" D. One year factory warranty. (Optional mobile cigarette lighter cord #901MPC \$4.99)

## UNIDEN MR 8100



**\$289.99**  
SPECIAL SALE PRICE ONLY (\$10.00 Shipping Each)

100 channel digital programmable mobile scanner, turbo scan up to 100 channels per second, lockout, priority, built-in automatic 2 second delay, dimmer control, back lighted keyboard, track tuning, direct programming of frequencies from front keyboard plus you can also program MR 8100 from your IBM compatible PC computer with software and cables included with scanner from Scanner World. Frequency coverage: 29-54 MHz, 118-174 MHz, 406-512 MHz, 806-956 MHz. Dimensions: 7.9" W x 5.8" H x 1.9" D. Earphone jack, BNC antenna jack, DC power cord, mobile mounting bracket, internal memory backup, bank scanning; 10 banks of 10 channels in any combination.

## RADIO SCANNERS

BEARCAT BC55XLT	108.99	(7.00)
BEARCAT BC70XLT	144.99	(7.00)
BEARCAT BC100XLT	159.99	(7.00)
BEARCAT BC140	94.99	(7.00)
BEARCAT BC142XL	94.99	(7.00)
BEARCAT BC147XL	99.99	(7.00)
BEARCAT BC200XLT	279.99	(7.00)
BEARCAT BC205XLT	239.99	(8.00)
BEARCAT BC310A	85.99	(7.00)
BEARCAT BC330A	109.99	(7.00)
BEARCAT BC400XLT	99.99	(7.00)
BEARCAT BC560XLT	109.99	(7.00)
BEARCAT BC760XLT	269.99	(7.00)
BEARCAT BC800XLT	249.99	(8.00)
BEARCAT BC855XLT	186.99	(8.00)
BEARCAT BC950XLT	249.99	(8.00)
COBRA SR901	74.99	(6.00)

MIDLAND CB Radios	In Stock
COBRA CB Radios	In Stock
UNIDEN CB Radios	In Stock
Two-Way Radio Batteries	In Stock
Scanner Antennas	In Stock
Power Supplies	In Stock

RELM RH606B	414.99	(9.00)
RELM UC202 (2 or more)	129.99	(6.00)

## SCANNER ACCESSORIES

BCAD70	14.99	BP4	24.99
BCAD100	14.99	BP55	16.99
BCAD140	14.99	MA917	24.99
BCAD 580	16.99	MA518	16.99
BC003	7.99	ESP25	16.99
BC002	59.99	GRE8002	79.99
PS001	12.99	GRE-HH	54.99
UA502A	12.99	GRE9001	89.99
BP205/200	34.99	GRE 3001	62.99
BP70	16.99	FBE	5.99
VC001	12.99	FBW	5.99

★ ALL MERCHANDISE NEW, IN FACTORY SEALED CARTONS

## BOOKS

Covert Intelligence	8.95
Air Scan Directory	14.99
Betty Bearcat	5.99
Top Secret (7th)	15.99
Covert Techniques	9.95
Tomcat's Big CB	13.95
World Radio	18.99
Survival Directory	6.95
Rail Scan	7.95
Police Call	8.69
Scanner Modification	17.99

## UNIDEN BEARCAT BC-400XLT



**\$99.99**

(\$7.00 shipping)

Our best selling mobile scanner, 16 channel, AC/DC, programmable, digital, AC/DC cords, telescopic antenna, mobile mounting bracket, weather search, priority, 29-54 MHz, 136-174 MHz, 406-512 MHz, external speaker and antenna jack

## BEARCAT BC-100XLT

100 Channel Digital Programmable Hand-Held Scanner

**\$159.99**

(\$7.00 shipping)

Our best price ever on a full featured complete package hand-held scanner. Manufactured by Uniden. Features include 11 bands of weather, aircraft, public service, trains, marine, plus more (29-54 MHz, 118-174 MHz, 406-512 MHz), 10 channel banks, 10 priority channels, lighted LCD display, earphone jack, channel lockout, AC/DC operation, scans 15 channels per second, track tuning. Special package deal includes following accessories: AC adapter/charger, rechargeable Ni-Cad battery pack, flexible rubber antenna, carry case.

## SANGEAN ATS-803A

SHORT WAVE RECEIVER

**\$168.99**

(\$7.00 shipping)

AM/FM/LW and 12 shortwave bands plus FM stereo, BFO for SSB reception, clock radio. Includes AC adapter, telescopic antenna, stereo headphones, and shoulder strap.



## BEARCAT BC-147XLT 16 CHANNEL BASE SCANNER

**\$99.99**

(\$7.00 Shipping)

Programmable, digital, AC/DC operation. Frequency coverage 29-54 MHz, 136-174 MHz, 406-512 MHz. Weather button, priority, lockout button, squelch includes AC adapter, telescopic antenna.

## UNIDEN BEARCAT BC-950 XLT



**\$249.99** (\$7.00 shipping)

Digital Programmable  
100 Channel Scanner

BC-950 XLT covers the following frequencies: 29-54 MHz, 118-174 MHz, 406-512 MHz, 806-954 MHz (excludes cellular). Features compact size of 6-5/16" Wx1-5/8" Hx7-3/8", scan delay, priority, memory backup, channel lockout, bank scanning, key lock, AC/DC power cords, telescopic antenna, mounting bracket supplied, one year factory warranty, search, direct channel access, track tuning, service search including preprogrammed frequencies by pushing a single button for police fire/emergency, aircraft, weather, and marine services plus exclusive optional features never available on any scanner before. First is an RF receive amplifier for boosting weak signals for only \$34.99 plus a CTCSS tone board is available for only \$59.99 to make this the number one scanner available in the USA. Optional cigarette lighter plug #950 MPC \$4.99.

## MODEL: FB-911 ORIGINAL FIRE BOX PHONE

**\$54.99** (\$5.50 Shipping Each)



13 memory phone, 3 direct access emergency memories, auto redial, ringer on/off, top light flashes when telephone is ringing, tone/pulse switchable, desk/wall mount, front door closes for authentic fire box appearance, FCC approved. Size: 16" Hx8 1/4" Wx7" D.

## GM-1<sup>TM</sup> GLASS MOUNT SCANNER ANTENNA

—ONLY AVAILABLE FROM SCANNER WORLD—

Frequency coverage 25-1200 MHz — only 22 inches tall. NEW REVISED DESIGN — no holes to drill — no glue needed. Complete with 17 foot cable, Motorola connector, and mounting hardware. Swivels to vertical position — performance unaffected by moisture on the window. Made in USA.



**\$39.99**

(\$4.00 Shipping Each)

## GLASS MOUNT ANTENNAS FOR TRANSCEIVERS

Includes mounting kit and cable. Low Band, High band and UHF band include PL259 connectors. 800 cellular band antenna includes TNC connector.

GM-27 27 MHz Low Band for CB	\$39.99 (\$4.00)
GM-155 144-174 MHz High Band	\$39.99 (\$4.00)
GM-450 450-470 MHz UHF Band	\$39.99 (\$4.00)
GM-800 Cellular Telephone Band	\$34.99 (\$4.00)

**ORDERING INFORMATION:** Call (518) 436-9606 to place orders or mail orders to Scanner World, USA®, 10 New Scotland Ave., Albany, N.Y. 12208. Orders will be shipped within 24 hours by United Parcel Service if order is accompanied by MasterCard, Visa, cashier's check, money order, COD (COD shipped by United Parcel Service will be cash or money order only). (If a COD package is refused, customer will be billed for shipping and COD charges.) Mail orders with personal or business checks enclosed will be held 4 weeks for bank clearance. Prices, specifications, and terms subject to change without prior notice. If items are out of stock we will backorder and notify you of delivery date. All shipments are F.O.B. Scanner World® warehouse in Albany, N.Y. We are not responsible for typographical errors. All merchandise carries full manufacturer's warranty. Bid proposals and purchase orders accepted from government agencies only. Free full line catalog mailed 4 times per year. Merchandise delivered in New York State add 7% sales tax. No returns accepted after 7 days of merchandise receipt. \*Add (\$ per item, and \$3.50\* for all accessories ordered at same time, COD orders will be charged an additional \$4.99 per package. Full insurance is included in shipping charges. All orders are shipped by United Parcel Service to street address only. (No P.O. Box). Shipping charges are for continental USA only. All others ask for quote on shipping charge.

# Beamed From Boston: Monitor Power

*One Of America's Shortwave Voices*

BY GERRY L. DEXTER

**I**t's hard to believe, but it's been more than five years now since the first shortwave voice of the Christian Science Monitor took to the air on March 30, 1987. It was a 500 kilowatt wallop heard 'round the world. By the time another three years had passed, "Monitor Shortwave" could be heard nearly everywhere on the globe, broadcasting from three transmitter sites at more than triple the original half million watts!

The stations are owned by the Christian Science Monitor Syndicate, Inc., which also publishes the world-famous newspaper, begun in 1908 by the founder of the First Church of Christ, Scientist, Mary Baker Eddy. The main offices for all of the various media efforts is at One Norway Street, Boston, MA 02115. These other media enterprises include a Boston TV station and a syndicated radio program "MonitorRadio" (heard on non-commercial stations in the US and Canada) and a news magazine, "World

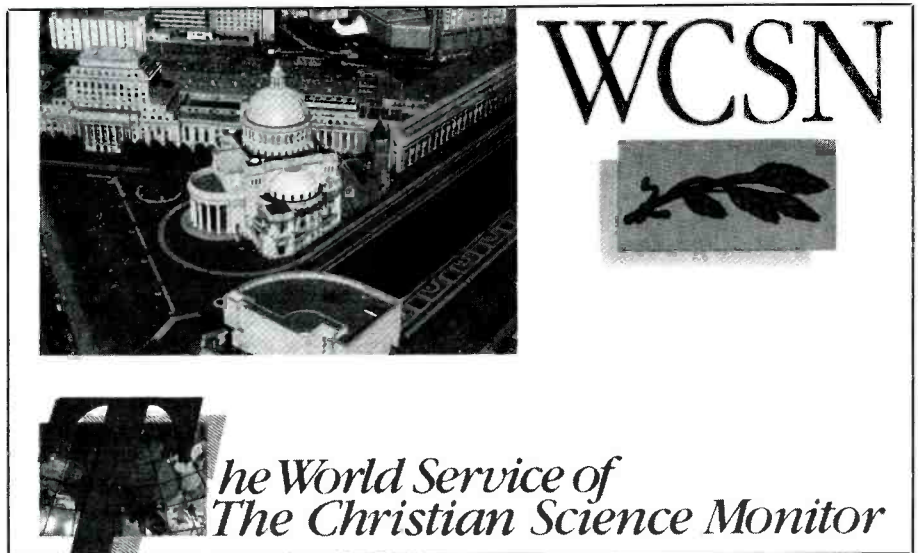

WCSN's early non-QSL QSL card.



Each station now has its own QSL.

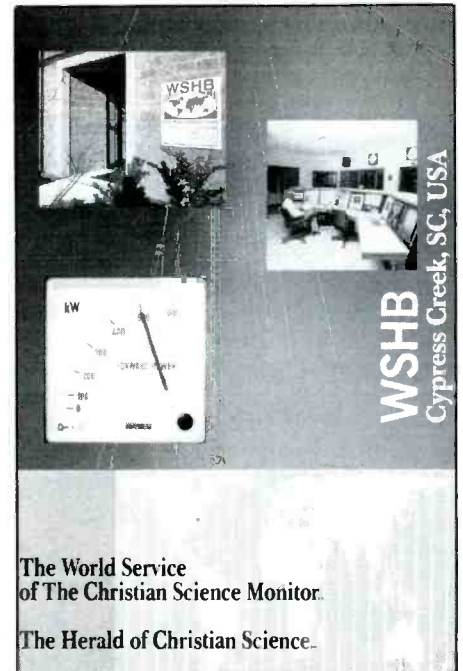

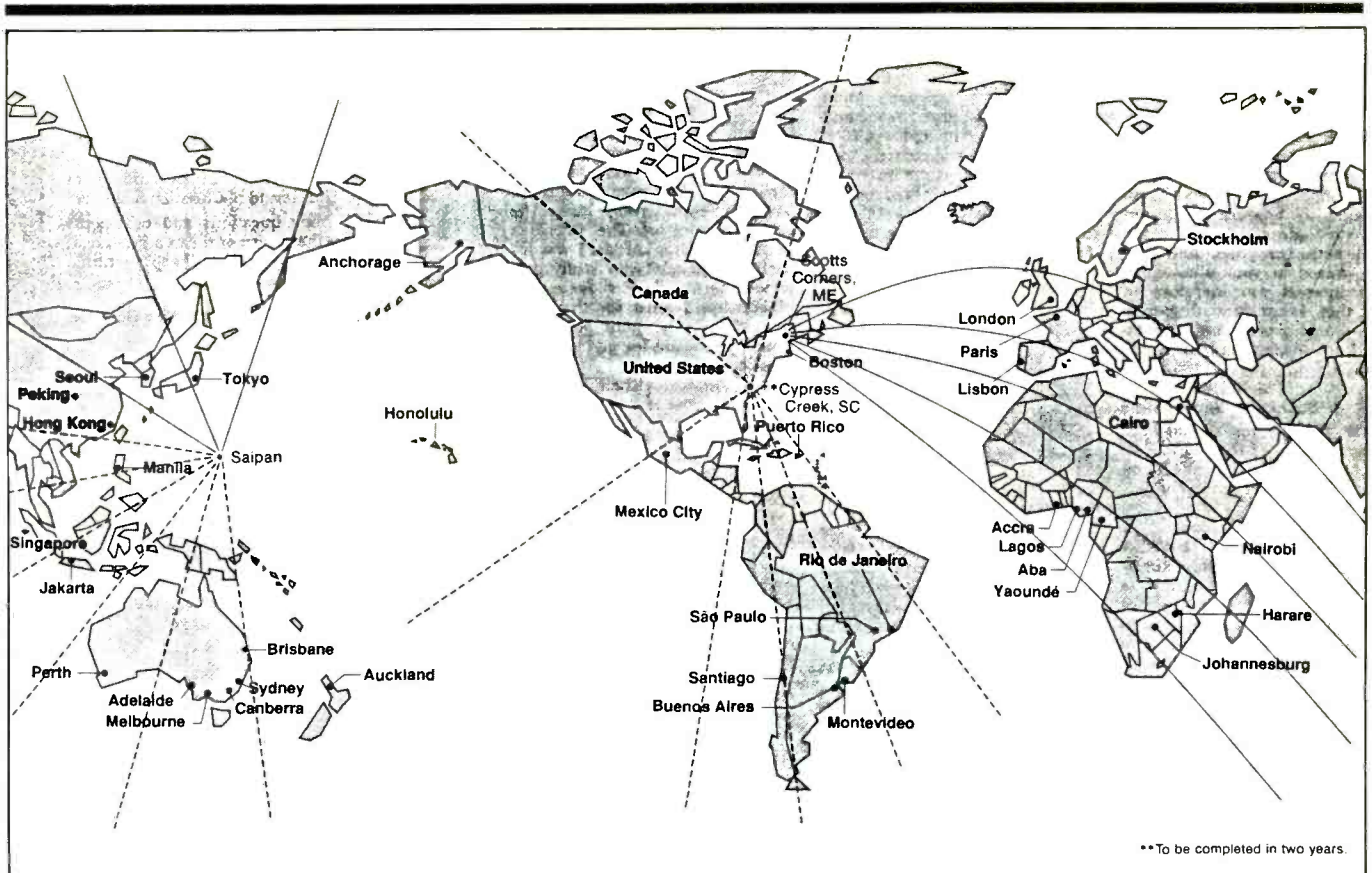

\*\*To be completed in two years.

The Monitor's three stations reach most of the world.

Monitor". "MonitorRadio" began as a one hour program on weekends but has expanded into two daily half hour shows.

The Monitor's shortwave service is really two. During the week "The World Service of the Christian Science Monitor" broadcasts a round the clock two hour program (beginning fresh at 1600 daily - through newscasts in the two hour block are updated). The World Service aims to provide unbiased and inde-

pendent programming of world news to a shortwave audience around the world.

Weekends (and sometimes into Mondays UTC for some areas) the programming is "The Herald of Christian Science," produced by the *Christian Science Publishing Society*, also in Boston. On Sundays this includes a broadcast of services from the Mother Church in Boston. The religious programming is "designed to show how Christian Scientists apply

their religious teachings to daily affairs and to life as a whole." The programming focuses on family and community issues and avoids the screaming, haranguing style of much of the commercial shortwave religion one finds all over the dial.

Beams of the World Service to Central and South America are half in English and half in Spanish from 0101 to 0706 UTC. In addition to English, the Herald of Christian Science is aired in German, Czech, Russian, Spanish, Portuguese and French.

Programming is produced at the Boston headquarters where the shortwave program team shares a twelve studio complex (including production studios) with producers and programmers of "MonitorRadio". Three full-time engineers maintain the facility, which uses computerized, automated audio distribution which can handle five different and simultaneous shortwave program feeds at once. Shortwave programming is sent via satellite to the three sites via Satcom II-R (plus Intelsat IV-A for Saipan).

Headquarters and the three stations have their own computer E-mail network which allows the stations to communicate with each other as well as with Boston. Plans were to eventually have all maintenance logs, parts inventories and so on in the computer so they could be accessed by any of the stations.

The first of the Christian Science Monitor stations was WCSN, located at Scotts Corner, Maine, about 25 miles north of Bangor.



The WCSN staff enjoys their Christmas party in the station lobby.



Judy Cook is an operator at WSHB and also handles QSLs.

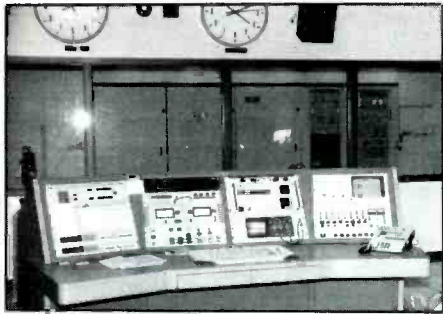

The transmitter operation console at WCSN.

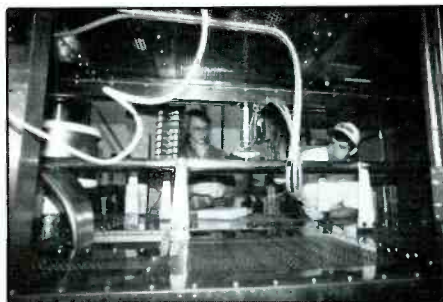

WSHB operators Calvin Giles and Clarence Causey do some routine cleaning of an RF output section in one of their 500 kW beasts.

The station, with its single, half million watt transmitter, sits at the end of a three quarter mile dirt road called, appropriately enough "Tower Road". The transmitter is a Brown Boveri. Three towers (2 of 363 feet and one 212 feet) support two larger dipole curtain arrays. One tunes between 11 and 22 MHz, the other 6 to 11 MHz. Each antenna consists of 16 wide frequency dipole curtains arranged in a 4 by 4 flat plan array. Behind this is a flat wire grid reflector. The antennas are stationary but are electrically "sleuable". Both were manufactured by TCI of California. WCSN (which stands for World Christian Science Network) beams to north, east, central and southern Europe. The western part of the Commonwealth of Independent States, the middle east, northwest, central and southern Africa and eastern Canada.

Four months before WCSN was ready for air action, the Monitor had purchased finan-

cially troubled shortwave rock station KYOI on Saipan Island in the US Commonwealth of the Northern Marianas. KYOI kept its call letters and its program fare for sometime. It was a year after WCSN came on the air and satellite feeds were worked out before World Service programs started on KYOI. At first, they were just added to the regular KYOI programming. KYOI was closed down in mid 1989 so that a second transmitter could be installed, along with a new antenna and the current facility upgraded. When transmissions resumed in November of that year KYOI had become KHBI (Herald Broadcasting International). Two - 100 kilowatt Continental Electronics transmitters were in play and two TCI curtain antennas similar to those used in Maine were in use. KHBI's signal is intended primarily for listeners in Japan, Korea, China, India, Indonesia, the Philippines, east Africa, Australia and New Zealand.

The third base in the Monitor's triple play game was WSHB (World Service/Herald Broadcasting) which came on the air on March 27, 1989. This one is the Papa Bear of the trio. There are two Brown Boveri 500 kilowatt transmitters at this station and five TCI antenna arrays to beam programming to Canada, Australia, New Zealand, Central

America, the Caribbean and eastern and western Latin America. With its high transmitter power and the gain provided by its antennas, WSHB claims to have more output than any other private broadcaster in the World.

QSL hunters initially received only no-data cards in response to their reports. Formal QSL's began being issued in 1990, after all three stations were up and running. Each station has its own distinctive QSL. The listener has to write to Boston to obtain a set of these cards, then fill them in based upon his or her reception details and mail them back. The cards are then sent to the individual stations for official verification/signature and returned to the SWL. Listeners are requested not to try to QSL any of the stations more than once. The World Service address is Post Office Box 860, Boston, MA 02123 (letters for "Herald" programming should go to Post Office Box 58, same zip. You can get up-to-the-minute frequency information by calling the Monitor's shortwave hotline at (617) 450-2060.

Tours of the Monitor's Boston radio facility are given Monday through Friday at 2pm. Staffers at the three stations are glad to give tours, also, but please give them some advance notice. ■



## "AND THEY SAID IT COULDN'T BE DONE!"

### THE NEW SANGEAN ATS-818CS PLL SYNTHESIZED WORLD BAND RECEIVER WITH PROGRAMMABLE CASSETTE RECORDER.

So hot it's setting the market on fire and burning up the competition.

That's because the ATS-818CS offers more features than most high priced table top models and delivers a level of performance that blows the other portables away. Without a doubt, this is one receiver you must see and hear to believe.

Backed by our 1 year warranty of quality and workmanship, it's no wonder Sangean has become the choice of short wave enthusiasts.



THE ATS-818 MODEL  
Identical to the ATS 818CS  
without the Programmable  
Cassette Recorder

The Sangean ATS-818CS features:

- All Short Wave Bands •
- Single Side Band & CW Reception •
- 45 Memory Presets •
- AM Wide/Narrow Filter •
- Dual Time Display •
- 5 Tuning Methods and more •

Call or write for more information.

**SANGEAN**  
AMERICA, INC.

A World Of Listening  
2651 Troy Ave., South El Monte, CA 91733  
(818) 579-1600 FAX: (818) 579-6806

CIRCLE 37 ON READER SERVICE CARD

# Scanning The Oddball Bands

## Search for Scanner Intrigue in the Overlooked Bands. You're Missing Plenty!

BY CHUCK ROBERTSON

**J**ust because manufacturers leave certain bands out of some or all of their basic scanners, it doesn't mean there's nothing to be heard there. To the contrary, some rather exotic and exciting things are taking place just outside the standard scanner bands. If you have equipment that can scan these frequencies, you'll want to direct your attention there. Here's how.

### Patrolling Grunge Beach

Some DX'ers call it Grunge Beach—that shadowy shoreline between 29.80 and 29.995 MHz that separates HF from VHF. Officially, this piece of real estate is primarily made up of 29.80 to 29.89 MHz and 29.91 and 29.995 MHz, dedicated to International Fixed (point-to-point) Public services. They're allocated for high-powered ionospheric scatter comms between land stations, or from land stations to aircraft. The stations run thousands of watts, although the majority of the power passes through the ionosphere and is lost in space.

A small amount of this power gets reflected off random patches of ionosphere in the E-layer, resulting in skip distances between 450 to 1,300 miles. Even when the Maximum Usable Frequency (MUF) is below 29 MHz, reliable comms on several non-voice channels (or one voice channel) are possible.

The channels for this are 29.81, 29.82, 29.83, 29.84, 29.85, 29.86, 29.87, 29.88, 29.89, 29.91, 29.92, 29.93, 29.94, 29.95, 29.96, 29.97, 29.98, and 29.99 MHz. The frequency gap from 29.89 to 29.91 MHz (discrete frequency 29.90 MHz) appears to be allocated for military use in the US and Canada.

In the US, ITT World Communications has bases in New York City and San Francisco on 29.84, 29.85, 29.87, 29.88, and 29.94 MHz. RCA Global Communications also has bases in these locations using 29.96 and 29.97 MHz.

There are some government contractors in this band, too, although I have never monitored their stations in use. I have heard military activity on 29.90 MHz, and my guess that it consists of all low-power operations.



*Some 10-Meter ham band SSB transceivers can be modified for unauthorized operation in the 29.80 to 29.995 MHz band, as well as other bootleg frequencies. This modified 25-watt President HR-2510 ham rig is given extra muscle on these channels by the 100 watt linear amplifier it's sitting on.*

But nature doesn't like a vacuum. The 29.80 to 29.995 MHz band is mostly crowded with illegal comms, as frequency stealers were delighted to have stumbled upon a piece of turf that isn't in much use by those stations that are supposed to be there. Same thing happened to the US Government band that runs from 27.54 to 27.995 MHz. It was another case of "use it or lose it." Uncle Sam hardly used it, so squatters moved in.

In the 29.80 to 29.995 MHz band, the illegal users are mostly American commercial fishing vessels. They are often heard in AM mode on 29.875, 29.89, and 29.93 MHz. Sometimes ham (USB) operators stray above their 29.70 MHz band edge and are heard here, too. You can also monitor drug runners, "gypsy" cabs in New York City, radio telephones, and business comms. Even hobbyists pop in from time to time in this band,

although not to the extent you'll hear them in the 27.54 to 27.995 MHz band. A couple of hobbyists in California heard between 29.80 to 29.995 MHz seem to be using their computers to automatically channel hop.

This time of the year, Sporadic-E skip will be bringing in signals from across North America and the Caribbean. Listen for Spanish language business ops in AM mode on 10 kHz channels (such as 29.93 and 29.94 MHz). Spanish language full-duplex telephone circuits show up on 5 kHz channels (like 29.815 and 29.825 kHz). If you hear voice scramblers and NFM mode here, it's probably Canadian commercial fishing vessels using the band illegally. Canada also has some legal low-power telemetry devices in this band, which you'll hear in AM mode with a beeping sound.

Mainly, you'll hear surreptitious comms.

Brian Webb, of Thousand Oaks, Calif., recently reported strange comms on 29.99 MHz, USB mode. "Air Bat" was in contact with "Charlie Juliet," and they sounded as if they were from a southeastern state. All very suspicious, and definitely not military.

Some 10 Meter band ham and some older CB transceivers can be modified to operate on these frequencies, and we presume that's been the basis for the influx of illegals in the band.

### Log These!

Between the 10 Meter ham band and the IFP band is the tiny and obscure 29.70 to 29.80 MHz band. In the US, it's allocated for use by companies producing forest products, including their mills and trucks. They are authorized for FM on 29.71, 29.73, 29.75, 29.77, and 29.79 MHz. Canada has business stations in this band. Most other nations either use it for military ops, or don't allow the use of the band at all.

Some illegals turn up here. Recently, I monitored a couple of Floridians on 29.725 MHz, FM. They were testing out a phone patch by dialing up an automated time-answering service that ID'ed as "The First National Bank of Osceola."

Give a listen for the loggers, and plenty of overseas illegals.

### Fed Fun

Although federal agency comms in the US are supposed to be restricted to certain specific bands, some fed users seem to turn up on any convenient frequency that pleases them at the moment. They can turn up unexpectedly on any frequency between DC and ultraviolet!

Many military VHF low band radios cover 30 to 76 MHz, and do it in 50 or 100 kHz steps. Scannists tend to overlook the 50 to 76 MHz band, either because they don't think they'll find anything good there, or because their scanners won't work there.

In the aftermath of Hurricane Hugo, the USS Bainbridge was monitored on 50.35 MHz working food distribution centers in the Virgin Islands. This is, of course, in the 6-Meter ham band, although the mil comms were in wide FM (WFM), whereas most hams in this band use USB mode.

The USAF Thunderbirds have been reported on 66.90 MHz, which falls within the 54 to 72 MHz TV broadcast band (TV Channels 2 to 4).

War games at the National Training Center, Ft. Irwin, Calif., are sometimes logged on 56.50, 56.65, 56.85, 51.00, and 72.00 MHz. Ops at McChord AFB, In Wash., are noted on 72.30 and 72.70 MHz. The 72 MHz channels are in the 72 to 76 MHz Operational/Fixed band. Wireless microphones used for surveillance in the US and Canada sometimes turn up in this band.

### Something New

This 72 to 76 MHz band is a strange little swath of frequencies left out of many basic

scanners even though it's used by police, business, and just about all other two-way communicators. High-power (up to 300 watts) transmissions occur here, as do transmissions from roadside callboxes, remote control devices, and 1-watt handheld transceivers.

In the September, 1990, issue of POP' COMM there was a full examination of the band, so right now all we need do us update you with some recent FCC changes. The former 74.60 to 75.40 MHz "guard band" protecting the 75 MHz Instrument Landing System (ILS) marker beacon channel has been trimmed down in size to 74.80 to 75.20 MHz. This has allowed the creation of new low-power frequencies that you should monitor for activity. These channels are: 74.61, 74.63, 74.65, 74.67, 74.69, 74.71, 74.73, 74.75, 74.77, 74.79, 75.21, 75.23, 75.25, 75.27, 75.29, 75.31, 75.33, 75.35, 75.37, and 75.39 MHz.

### Weird Science

The frequency bands of 40.66 to 40.70 MHz, 216 to 220 MHz, and 400 to 406 MHz host all sorts of telemetry and experimental stations. This includes sea buoys, wildlife tracking, earthquake sensors, proximity detectors, flood-level sensors, radiosondes, security and safety devices, and numerous types of non-voice transmitters used by business and industry, power utilities, and the federal government.

The 216 to 220 MHz band is shared with the Automated Maritime Telecommunications System (AMTS), which we reported on in detail in the August, 1991, issue of POP'COMM. AMTS is currently operational along the Gulf of Mexico as well as the Mississippi and its navigable tributaries. Vessels transmit between 219.0125 and 219.9875 MHz, 18 watts max. ERP. Full duplex base stations operate with 1 kW ERP from 217.0125 to 217.9875 MHz. NFM mode is used, with channels spaced at 12.5 kHz.

AMTS carries ship/ship and ship/shore comms, both voice and non-voice (mostly FAX).

Many readers report hearing beeping and other odd sounds in the 40.66 to 40.70 MHz band. The discrete frequency is 40.68 MHz, which is authorized for industrial, scientific, and medical devices (no power limits). Who knows what hideous devices you might be monitoring here. Other similarly allocated frequencies include the HF channels 6.750 MHz, 13.560 MHz, and 27.120 MHz, as well as the UHF frequency of 915.0 MHz. Note that 27.120 MHz is midway between CB Channels 13 and 14.

Many federal government telemetry activities are between 40 and 41 MHz, although 40.45 MHz is used by the VA for paging in some areas.

### Ready, Set, Scan!

Now you're ready, and you're set to scan. Like the man said, monitor till it Hertz! ■

# Receive digital signals on shortwave

See AP wire news photos, weather maps, news over RTTY, Amtor ship-to-shore, Navtex, slow scan TV, ASCII, Morse code and packet radio -- all on your computer screen!



MFJ-1278

**\$27995**

See tomorrow's news today on your computer screen when you copy crisp, clear AP news

photos. You'll also enjoy high resolution WeFAX weather maps, multi-gray SSTV pictures and full color packet radio pictures. You'll also copy the digital text modes: RTTY, Amtor, Navtex, ASCII, Morse and packet.



AP wire photo received on 20.738 MHz using MFJ-1278 with MFJ-1289 Multicom.

All you need is the MFJ-1278 multimode data controller, HF and/or VHF/UHF receiver and your computer with MFJ software.

**Don't be confused by a barrage of unknown digital signals -- let Automatic Signal Analysis™ tell you what they are**

MFJ-1278's ASA™ detects RTTY, Amtor, ASCII and HF Packet signals. After ASA tells you what you're hearing, you just type an "OK" command to display the copy on your computer screen.

**MFJ Multicom™ and MFJ Multicom64™ -- software that brings out the full power of your MFJ-1278 with multi-gray modem**

MFJ Multicom™ for IBM compatible computers (MFJ-1289, \$59.95) gives AP photos and weather

maps with up to 8 gray levels. MFJ Multicom64™ (MFJ-1282B \$39.95) gives you multiple gray levels on your Commodore 64/128.



Weather map received on 16.410 MHz using MFJ-1278 with MFJ-1289 Multicom.

These programs include a computer cable and friendly instructions -- everything you need to get started fast.

To enjoy receiving text modes off the air with your MFJ-1278, you can use any computer with a serial port and simple terminal program.

**Feature packed for superb operation**

Dual radio ports let you connect two radios (each HF or VHF/UHF); 20 LED precision tuning indicator lets you tune in signals to an incredible 10 Hz accuracy -- even if you don't have digital readout; free AC power supply (or use 12 VDC); RS-232 and TTL serial ports make it easy to use with virtually any computer; one year unconditional guarantee and much, much more.

**Enjoy an exciting new world of SWLING**

Enjoy thrilling multi-gray AP news photos, weather maps and digital text with the MFJ-1278 multimode data controller. Get yours today!

**Nearest Dealer/Orders: 800-647-1800**

**MFJ** MFJ ENTERPRISES, INC.  
Box 494, Miss. State, MS 39762  
(601) 323-5869; FAX: (601) 323-6551  
Add \$5 each product ordered s/h.  
**MFJ . . . making quality affordable**

CIRCLE 7 ON READER SERVICE CARD

# Radio: The Way It Was

## A Look Back Into The Golden Era, & Earlier!

BY ALICE BRANNIGAN

One of America's most fabled offshore resorts is Avalon, on California's Catalina Island. Almost lost in the passing years is the wireless station put into service in 1902 at Avalon under the auspices of Robert H. Marriott's Pacific Wireless Company.

Being twenty-five miles offshore, until this station was put on the air Catalina had no means of communication with the mainland except for the boat, and that wasn't too reliable, especially during bad weather.

Pacific Wireless was a small company that was opening stations along the coast at the turn of the century. Their network consisted of San Francisco (call letters "SF"), Seattle ("DA"), and Port Townsend, Wash. ("D"). Their station in Avalon ("A") was put there to communicate with the Los Angeles station ("G"), which was located at 7th Street and Alameda.

Although the Alameda station announced it would handle Western Union telegrams, one of its first uses was to receive the results of the big Jeffries-Fitzsimmons fight that took place in San Francisco. The telegraph station had the results for the Avalon newspaper to publish many hours before the local steamer arrived carrying the same information.

Skeptics on the island doubted the authenticity of the early wireless fight results and refused to pay on bets until steamer confirmation arrived. Even after the fight results were confirmed, many people didn't believe that invisible electrical signals could actually carry messages over such distances without wires. Some claimed that carrier pigeons were used, others insisted that powerful lights on the mainland were used to flash the results. Additional theories were also put forth to explain the way the fight results had gotten there so quickly.

Being a fine resort area, Avalon has always had expensive hotels and a well-heeled clientele. Such are the magnets that also attract a certain criminal element. Avalon, in particular, was a good target because once the steamer left the dock carrying the thieves toward the mainland, they were so far ahead of any pursuers that they were practically home free.

One morning two men sailed from Avalon on the 5 a. m. steamer before it was discov-



This 1905 picture postcard shows Catalina station "A" with its mast, located on a bluff above the beach.

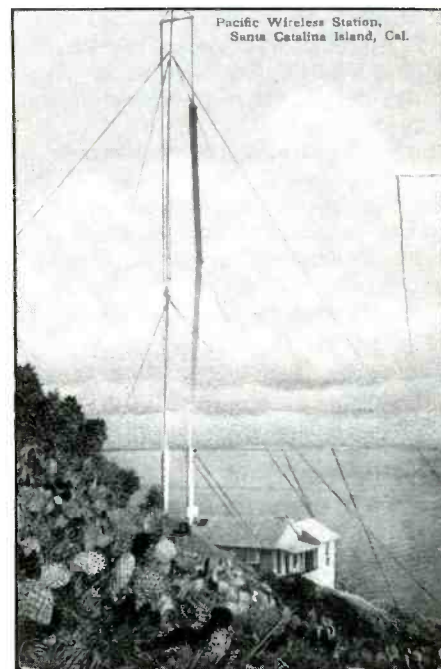

An undated early picture postcard of the Catalina station taken from a slightly different angle reveals the mast used to support a vertically mounted wire cage antenna system.

ered that during the night, they had helped themselves to cash and bottles of expensive wine from the bar at the Metropole Hotel. When the theft was realized, local residents assumed that it was another virtually perfect crime. The sharp hotel manager, though, promptly sent a wireless message to the mainland. That resulted in the police waiting to pick up the men when the steamer pulled into the dock at San Pedro. Wireless had changed the steamer from the route to freedom into a trap from which there was no escape.

The station evolved as technology improved, later using two-way voice instead of telegraph for its communications. According to a statement made (April, 1926, issue of *Radio Broadcast*) by Pacific Wireless' Robert H. Marriott, radiotelephony is what led to the closing of the station in July, 1923. He wrote,

"Too many uninvited folks were able to listen in." An underwater cable was then used for the services previously exchanged by radio.

Robert H. Marriott became the first President of the Institute of Radio Engineers.

### Pump Up The Volume & The Oil

Rebecca Krench, of Rockford, Ill., writes to say that she and her brother, Robert, haunt flea markets and antique shops looking for books and old radio items. One of Rebecca's recent finds was an undated old postcard from station KFDM. This wasn't a QSL card, but a card sent out to listeners who wrote in to the station's *Children's Hour* program. Although intended to appear individually handwritten and personally signed by "Miss Magnolia Blossom" (undoubtedly the program's hostess), everything is machine printed.



# NO PROBLEMO

You want a bargraph & a full range counter – Optoelectronics can deliver!

**\$199.**  
Don't Wait,  
This Offer Can't Last!  
No discounts. No trade-ins.

Now for a limited time only, \$160. off the list price. for our Full Range Model 2810 with bargraph – plus:

- Full range -10Hz to 3GHz.
- LCD display (daylight visibility).
- True state-of-the-art technology with the high speed ASIC.
- NiCads & Charger included.
- Ultra-high sensitivity.
- 4 fast gate times.
- Extruded metal case.
- Compatible with MFJ207.

#### Suggested options

##### TA100S:

Telescoping Whip Antenna.....\$ 12.

##### CC30

Vinyl Carry Case.....\$ 15.

##### BL28:

EL Backlight for use in roomlight and low light.....\$ 45.

##### TCXO 30:

Precision  $\pm 0.2$ ppm 20 to 40°C temp. compensated time base .....\$100.

Universal  
Handi-Counter™  
Model 3000, \$375. and  
Bench Model 8030, \$579.  
Both offer frequency,  
period, ratio and time  
interval.



**Made in  
the USA**

## OPTOELECTRONICS

Call for free catalog - Factory Direct Order Line:

# 1-800-327-5912

FL (305)771-2050 • FAX (305)771-2052

5821 NE 14th Ave. • Ft. Lauderdale, FL 33334  
5% Ship/Handling (Max. \$10) U.S. & Canada.  
15% outside continental U.S.A.  
Visa and Master Card accepted.



*In this distant view of the beach at Catalina, we see the station there (left center, on the beach) with two masts. This was probably taken late in the station's career.*

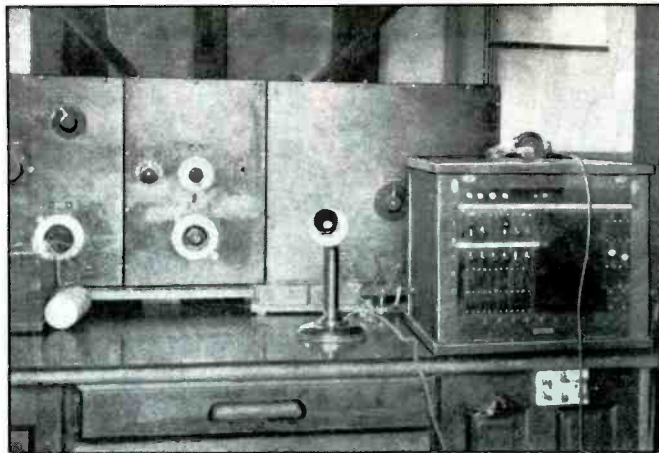

*The Catalina station's operating position in the early 1920's, when it used voice. The station was closed in 1923 because too many people liked to listen in on its traffic.*

This was a good find! Rebecca advises that she found out that KFDM, which the card mentioned was running 500 watts on 315.6 meters (that's 950 kHz), was owned by the Magnolia Petroleum Company, Beaumont, Texas. She estimates that the card is from the late 1920's, and hopes we have more information on KFDM.

KFDM started out in 1924, but then it was known as WMAM, with 100 watts on 833 kHz, and owned by the Beaumont Radio Equipment Company. A year later, Magnolia Petroleum owned the station, and it was operating on 950 kHz. The station's slogan, based upon its call letters, was *Call For Dependable Magnolene*. This made reference to the refinery's car lubricant.

By 1927, KFDM had moved to 800 kHz, so we'll date Rebecca's card in the 1925 to 1926 time frame. The year 1928 saw KFDM on 620 kHz, then shifted to 550 kHz in November of that year. As the 1930's rolled in, KFDM moved up to 560 kHz and had its studios in the Hotel Beaumont. The station's two 200 ft. towers were located at Doucette and Grove Streets, Beaumont. Magnolia Petroleum still owned KFDM, but the station was licensed under the name Sabine Broadcasting Corp.

By the 1940's, KFDM was running 1 kW, but moved to 5 kW in the 1950's. Towards the end of the 1960's, KFDM became KLVI. These days, running a Country/Western music format, KLVI still serves Beaumont on 560 with 5 kW. Since July of 1987, KLVI has been owned by the Hicks Broadcasting Corp.

jingles were produced this way, which often led to legal action.

There were a handful of jingle production companies, mostly located in Dallas. They sent their jingles out to stations across the nation. Usually, the production company would record the basic music at one time for a set of jingles, then just have singers overdub custom words for each station purchasing a set. Really cheap sets came with the music and most of the words prerecorded, with just the call letters dubbed in.

Paul has many hours of jingles on tape. These are mostly dubs from radio station masters, also some from air checks and from other collectors. He would be interested in hearing from anyone with similar interests. Contact him at: Paul J. Carlson, 103 Drood Lane, Pittsburgh, PA 15237.

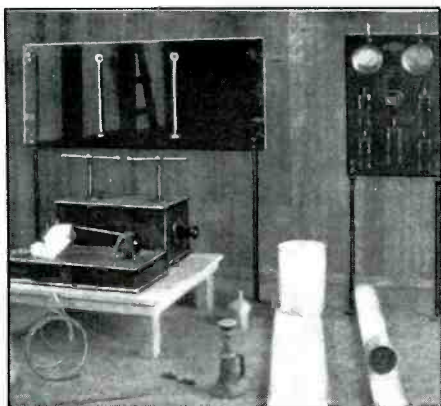

*Interior of the Catalina station as it looked in 1902. The switchboard at the right controlled the electric power. The large panel to the left rear carried two remote control switch arms to change the antenna from "send" to "receive." Just below it in the photo is the box with the spark rods, which was an induction coil capable of producing a 20-inch spark, although actually delivering a .75-inch spark into the antenna. The piece of paper at the left covers a mechanical interrupter which, at the time the photo was taken, was a secret.*

### **Hobby Lobby**

There are many unusual and fascinating specialties in the radio hobby. One was recently made known to me by Paul J. Carlson, who collects recordings of old broadcast station ID jingles from the late 1950's and early 1960's. This was the golden age of AM rock radio, when many stations had dozens of clever jingles for their call letters, weather, traffic reports, news programs, and for individual deejays.

To demonstrate this, Paul sent along a cassette of the Anita Kerr singers doing a whole string of jingles for Pittsburgh's KQV, back in 1957. This was just great, and came complete with all of the recording studio chatter, false starts, and out takes.

Paul told us that the KQV tape was unusual in that it had a live music combo in the recording studio. Many jingles were sung with live voices over a prerecorded music track, using the same standard canned music for dozens of different stations. Sometimes copies of the music track were bootlegged and used by broadcasters who hired their own singers to add in the words for their own stations. Occasionally, parodies of a competing station's

### **The Feeling is Mutual**

Douglas H. Stingley, of Salem, Oregon, wrote to mention that we have, in the past, written about the ABC, CBS, and NBC networks. But he is curious about the Mutual Broadcasting System (MBS), which was a major radio network for many years and we have not had any occasion to include in these pages. He reminds us that MBS was the first radio network to treat college football in a big time way. Douglas asks for background information on MBS, why it never expanded into a TV network, and what became of MBS.

In 1934, when it began, MBS was called the Quality Network. Soon afterwards, the operation took the MBS name. The original network consisted of WXYZ, Detroit; and 50 kW clear channel stations WOR, New York City/Newark; WGN, Chicago; and WLW, Cincinnati (which was then beginning 500 kW test broadcasts).

The first big attraction MBS had was *The Lone Ranger*, which came from WXYZ. While NBC and CBS owned and operated its major stations, and had affiliates under contract, MBS was different. The four MBS stations were independently owned, and

cooperatively run by MBS. In 1936, WXYZ decided to join NBC, and its spot in MBS was taken over by Windsor's CKLW. At that time, a number of regional networks and independent stations around the nation began affiliating with MBS. Some of the new MBS affiliates were basically affiliates of the other two major networks and relied upon MBS for programming only on a secondary basis.

Few, indeed, of the MBS stations were the stations with the highest power or the largest audiences during the 1930's in their respective areas. MBS did not achieve national equality with CBS or NBC, neither could it deliver the same amount of daily programming. Although MBS had a good Network News Division, it couldn't attract the same top entertainment talent, nor advertisers, nor audiences that NBC/CBS were able to garner.

Initially, at least, MBS treated its affiliates a bit more liberally than did the two major networks. That lasted only until 1938 when MBS felt the need to become more demanding of its affiliates in order to keep them from drifting out of the network as competition for affiliates became tougher. As time went on, however, MBS, did acquire many affiliates and had become the network with the largest number of affiliated stations.

The years were unkind to traditional network radio as the 1950's and TV came along. The old radio programs were either on TV or else they were gone. Many radio stations let their network affiliations lapse, or else retained only the networks' news feeds. CBS, NBC, and ABC began pouring their efforts into TV during the 1950's.

The 1950's, however, saw MBS itself sold no less than six times in a three year period. Nearly 150 MBS affiliates pulled out of the



One of the early participants in MBS was WXYZ, Detroit, home of "The Lone Ranger."

K F D M



D M

315.6 Meters.

500 Watts

*Dear Little Friends of the Air  
I was pleased to receive your ray of sunshine and take this means of thanking you. I hope you will continue to enjoy the Children's Hour which is given each Tuesday and Friday at 7 P. M., Central Standard Time. Let me hear from you again. With best wishes,  
Miss Magnolia Blossom.*

This isn't a personally handwritten card from KFDM. It just looks like one. (Courtesy Rebecca Krench, III.)

network at that time. Some of the 1950's management teams were less than the best, one being found guilty of manipulating the company stock. Another owner was charged with asking Dominican dictator Trujillo to pay the network for mentioning him in glowing terms during news broadcasts.

MBS continued to function, however, and

was popular in some markets. As the 1960's came along, networks began to again pay attention to building their radio operations. They did this by offering to supply a variety of different types of program formats. This cut into MBS' market, and a suit brought by MBS to end the practice because it violated the FCC's "duopoly" rule was thrown out of

**MAGNOLIA PETROLEUM COMPANY**

PETROLEUM, PETROLEUM PRODUCTS

OFFICE OF  
RADIO DEPARTMENT  
STATION  
K. F. D. M.  
(CALL FOR DEPENDABLE MAGNOLINE)

REFINERY DEPARTMENT

REFINERIES  
BEAUMONT, CORSICANA,  
FORT WORTH

BEAUMONT, TEXAS

February 9, 1931



Dear Friend:

In verifying your reception of our anniversary program on January 17th and 18th., we are submitting this letter and verification stamp.

When your motor needs gas and lubricating oil we advise that you use SOCONY.



LOS:DGL

Yours very truly,  
RADIO STATION K F D M

*Lee O. Smith*  
Lee O. Smith,  
STATION MANAGER.

A 1931 QSL letter from Beaumont's KFDM displays the station's own custom veri stamp in the upper right, plus an (applied upside down) company sticker at the lower left.

We wish to verify your reception of station W1XAL operating on a frequency of 6040 kilocycles with a power of 2000 watts on 1-2-3-3-3. We hope you will listen often and let us have your comments.

Cordially yours,

SHORTWAVE AND TELEVISION CORPORATION

70 Brookline Avenue, Boston, Mass.

Experimental Sound Station W1XAV, Ultra-short wave station W1XG and operators of International Short Wave Station W1XAL.

This QSL from W1XAL dated 1933 was found in a flea market. (Courtesy Tom Mooneyham, Md.)

court. MBS did make some headway with offering classic radio programs to stations.

Eventually, MBS was purchased by Amway Products. In 1985, Amway sold MBS to Westwood One (owners of NBC) for \$39-million. Westwood One now owns and operates NBC, the Westwood One Network, and also MBS.

An excellent source of information on radio networks is the book *Stay Tuned: A Concise History of American Broadcasting, 2nd Edition*, by Christopher H. Sterling and John M. Kittross (1990, Wadsworth Publishing Company, Belmont, Calif.).

### Another Flea Market Find!

Looks like lots of people are now converging on flea markets to look for radio goodies. Next thing on top of our stack of mail is from Tom Mooneyham, Maugansville, Maryland. He picked up 300 old ham radio QSL's at a flea market, and also two cards that were obviously not from hams. He thought that we would find them of interest, and that was a good guess.

Both cards are from 1933, and relate to Experimental Station W1XAL, Shortwave and Television Corporation, 70 Brookline Ave,

Boston, Mass. One card mentions that they operated TV video station W1XAV, TV audio station W1XAU, ultra shortwave station W1XG, and International Short Wave Station W1XAL.

As it turns out, W1XAL was a well known station in its day. The QSL card Tom sent notes that W1XAL ran 2 kW on 6040 kHz. Our files indicate that the station also operated on 11790, 15250, and 21460 kHz, and was running 5 kW by 1935 when it was being operated by the World Wide Broadcasting Corp.

This station was financed by the famous

## RANGER SDM-1000

BASE MICROPHONE WITH UP/DOWN SCANNING

High-Fidelity Wide band frequency response give your station that broadcast studio sound!

- Electret element and high quality SMT-amplifier
- Modern slim line design - easy to use with minimum space requirement
- Designed for use with all amateur transceivers: HF-VHF-UHF-SHF
- Factory pre-wired for most popular transceivers
- Up-down buttons-locking type PTT switch
- Stable, heavy-duty, die-cast base
- Long-life watch type battery

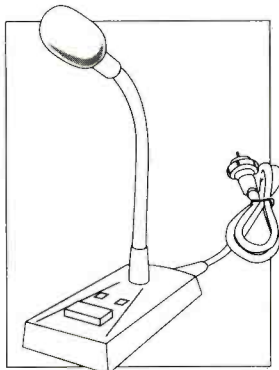

Pre-wired for:  
AR3300-AR3500-YAESU 8 pin transceivers  
Model F AR3300-AR3500-YAESU 8 pin transceivers  
Model H HR-2510(LINCOLN)  
Model I RCI 2900/2950



CLEAR CHANNEL CORPORATION

PO Box 445  
Issaquah, WA 98027  
206-222-4295 FAX 206-222-4294

## High Performance 800MHz

FREE CELLULAR FREQUENCY CHARTS!

### MAX 800 GROUND PLANE

- Absolutely the best reception . . . 10 times better!!!
- Astounding results outside using our RG6 cable
- Mount directly on base or hand-held scanner

Only \$19.95

Base scanner adapter - \$15.00  
Hand-held scanner adapter - \$12.00  
50 ft RG-6 cable assembly - \$35.00

Max Cellular Mag Mount - mobile 800 scanner antenna - \$29.95  
The Stinger - compact 800 MHz hand scanner antenna - \$7.95  
Loop Yagi - highly directional 15dB gain (3ft boom) - \$75.00

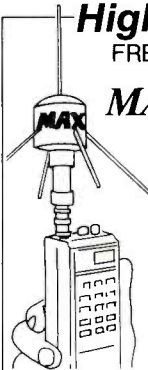

## Cordless and Baby Monitors

FREE CORDLESS FREQUENCY CHARTS!

### MAX 46-49 MHz DIPOLE

- The very best cordless phone and baby monitor antenna
- Hear conversations for miles around - don't miss anything!
- Install inside or outside
- Includes 50ft RG8X - BNC

Only \$49.95



## MAX System™ Antennas and Accessories

1-800-487-7539 ORDERS ONLY

508-768-7486 FAX  
508-281-8892 INFO  
SASE for free Catalog

146/220/440/GMRS GP	25.95
Telescopic Whip	12.95
Telescopic GP	29.95
146/220 Mag Mount	29.95
146/440 Mag Mount	29.95
BNC Mag Mount	12.95
Custom Ground Plane	39.95
Telescopic Mag Mount	29.95
3 Element 2m Quad	39.95

Send Payment To: Cellular Security Group  
4 Gerring Road  
Gloucester, MA 01930

CK-MO-MC-VISA Accepted (MA add 5%)  
US shipping and handling \$4.00

# OPTOELECTRONICS

*"Here at Radio School classes held throughout the country, the only counters that we will use are Optoelectronics' Handi-Counters."*

*Gordon West*  
Gordon West  
President  
Radio School,  
Inc.



Made in the USA

**Our Name says quality, service and dependability – Our customers agree!**

*"The best part of the Optoelectronics LCD counters are their extreme sensitivity, their brilliant LCD readout that can be seen even in bright sunlight and the rugged construction allowing them to get banged around, but still continue to operate smack dab on frequency... Yours is the only counter which reliably gives us (at Radio School) an instant frequency readout with its rock-steady LCD digits featuring incredible 1Hz resolution."*

Gordon West

**Optoelectronics has satisfied its customers for over 18 years – See for yourself what countless others have already discovered!**



*"I was encouraged by one of my readers words of wisdom, and bought the Model 2300. Your service was superb! After testing this unit I*

*personally feel that all serious radio enthusiasts should own an Optoelectronics Frequency Finder"*

Ron Bruckman  
Radio Monitors Newsletter  
Of Maryland

**FACTORY DIRECT ORDER LINE**  
**1-800-327-5912**  
**(305)771-2050 • FAX(305)771-2052**

5821 NE 14th Avenue • Fort Lauderdale, FL 33334  
5% Shipping Handling, (Maximum \$10) U.S. & Canada. 15% outside continental U.S.A. In Florida add 6% sales tax.  
Visa and MasterCard accepted.

Model	8030	3000	2600H	2810	2600HA	2210A	2300
Function	Freq, Period Ratio, Interval	Freq, Period Ratio, Interval	Frequency	Frequency	Frequency	Frequency	Frequency
Range	10Hz-3.0GHz	10Hz-3.0GHz	1MHz-3.0GHz	10Hz-3.0GHz	1MHz-3.0GHz	10Hz-2.4GHz	1MHz-2.4GHz
Display	10 Digit LCD w/Function Annunciators	10 Digit LCD w/Function Annunciators	10 Digit LCD	10 Digit LCD	10 Digit LCD	8 Digit LED	8 Digit LED
RF Signal Strength Indicator	16 Segment Adjustable Bargraph	16 Segment Adjustable Bargraph	16 Segment Adjustable Bargraph	.	.	.	.
Hold Switch	Yes	Yes	Yes	Yes	Yes	No	Yes
Price	\$579.	\$375.	\$325.	\$259.	\$225.	\$179.	*\$99.
<small>Sensitivity: &lt;1 to &lt;10mV typical. Time Base: +1ppm; +2ppm add \$100. - LCD Models only. Nicads &amp; AC charger/adaptor included except for 2300. *For 2300, available with NiCad installed &amp; AC charger/adaptor, complete package \$128. A full line of Antennas, Probes &amp; Carry case are sold separately. (One year parts &amp; labor warranty.)</small>							

WORLD WIDE BROADCASTING CORPORATION  
INTERNATIONAL RADIO BROADCAST TRANSMITTERS

WRUW WRUS WRUL WRUA WRUX  
Hatherly Beach, Scituate, Mass., U. S. A.

Your report dated

September 4, 1947  
received. Thank you.



Our program log verifies  
that you were listening to  
WRUS as reported.  
A

All "Short wave listener reports" will receive prompt attention.

Issued To: Thomas Kneitel

Shortwave broadcaster WRUL evolved from WIXAL. This QSL is from 1947, long before WRUL became history. (Courtesy Tom Kneitel, NY.)

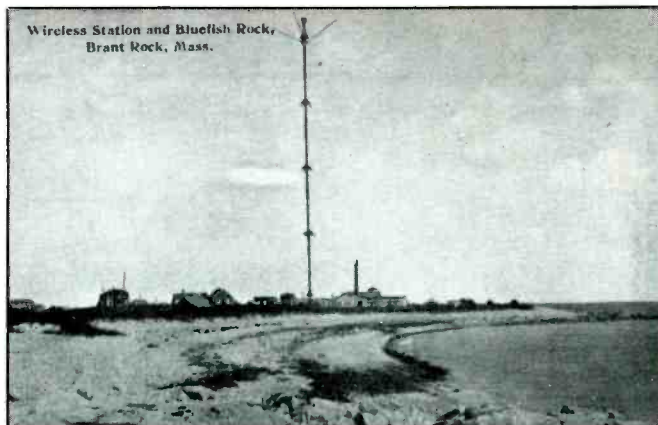

Fessenden's tubular transmitting tower at Brant Rock, Mass. was razed about 1912 or 1913.

Rockefeller family, and presented educational features, college courses from the Harvard campus and also the station's studios. Classical music programs were also presented. Other special programs were broadcast as well, as indicated by the second card sent to us by Tom, which tells about WIXAL's relay of a 30-minute program from medium-wave station WEEL.

World Wide Broadcasting Corp. evolved WIXAL into shortwave broadcaster WRUL, with transmitters at Scituate Mass. This station later got a new owner and became WNYW, then eventually was sold again and turned into modern-day WCSN.

### Let's Not Forget Fessenden

What with assorted stations insisting that they were the first to make a broadcast, we sometimes get to think that maybe they ought to remember that Reginald Fessenden seems to have done it ahead of everybody.

It was on Christmas Eve, in 1906 that he sent out the sounds of *Silent Night* on the airwaves, thereby astonishing wireless operators aboard United Fruit Company ships a thousand miles distant. At the time, it made world headlines. He sent out a similar broadcast a week later, on New Years Eve.

Reginald Aubrey Fessenden's 1906 broadcasts not only contained seasonal music, but also operatic arias, and his own voice. They were sent out from Brant Rock, Mass., and directed at wireless operators of the banana fleet. Until then, all they had ever heard were raspy code signals from spark gap transmitters.

Despite this amazing 1906 broadcast by Fessenden, the Canadian radio pioneer seems to have gotten lost in the shuffle of other names and personalities the public now thinks of in connection with early broadcasting, which formally began on a commercial basis in 1921.

Fessenden's first broadcast was in Decem-

ber of 1900, and took place at Cobb Island, Md. Using an antenna consisting of a mile of wire strung 45 ft. above the ground, he transmitted his voice. This was a year before Guglielmo Marconi transmitted a single code letter across the Atlantic.

Marconi was colorful and outgoing, and knew how to promote himself and his work to the public. Fessenden was no less colorful, but not in a way that would ensure him Marconi's commercial success, fame, or place in history. He was a temperamental eccentric, who wore flowing capes and who loved cats. He was so brilliant that in grade school, he taught himself Hebrew, Arabic, and Sanskrit.

His career ranged from working as a chemist for Thomas Edison to designing electric generators for George Westinghouse, from developing insulation for electric wires to inventing machine-gun tracer bullets.

Of all the things Fessenden was, one thing he wasn't was a businessman. His violent temper scared away most potential backers for his inventions. Those who didn't get scared off either failed in backing Fessenden, or were later sued by him.

He had many of his own patents, but had to constantly fight to protect them from being infringed upon by others. In 1928, after years in court, he agreed to a \$25-million settlement from the Radio Trust of America, representing major equipment manufacturers.

Fessenden died in 1932, at age 66, in Bermuda. In 1987, Canada honored him with a postage stamp. Other than that, he has received scant public attention or recognition.

Engraved in Egyptian hieroglyphics on Fessenden's tombstone is: "I am yesterday and I know tomorrow."

Thanks to Rene A. Matthijssen, Edmonton, Alberta, for suggesting this one-of-a-kind pioneer and his 1906 broadcasts as a topic to cover here.

We are out of here until August. We appreciate questions, suggestions, comments, old QSL's (originals or photocopies), old radio photos and postcards, station directories, and all other items sent for our use here. ■

# High Tech Satellite Imagery!

Feature in April and May 1990 issues of QST magazine

Achieve professional results—often surpassing the capabilities of local TV weather reporting. Plug it into your receiver earphone jack and decode all APT modes—GOES & Polar satellites as well as HF Marine fax. Capture, enhance, print gray scale weather facsimile using your PC. Latest technology for optimal noise rejection, self-test modes, advanced menu-driven software and help windows assure easy operation.

FCC Certified

LOOK AT THESE FEATURES!

- All modes: GOES-WEFAX, GOES-TAP, NOAA, Meteor, Meteorat, HF-WEFAX, HF-Marine/C-Band wire protoe
- Full satellite pass at full resolution
- 1280x1024 with 256 colors and below
- Temperature calibration & contour maps
- Latitude/longitude grids and "you are here" function
- Unattended operation & 24-hour schedule/timer
- Standard TIFF and GIF file formats
- User-defined palettes, interpolation, zoom, scroll, rotate, reverse, histograms, brightness, contrast, negative, linear/logarithmic enhancement curves.
- Integrated GOES-TAP and WEFAX animation
- Print gray-scale on laser and dot matrix printers

Half-sized card plugs into your PC

Qty	Price	Total
	\$355	
	\$495	

Complete kit/software  
Assembled card/software  
Foreign orders - add \$14 shipping  
Total

6404 Lakeroyal Court  
Raleigh, N.C. 27612  
Telephone: 1-919-847-4545

MasterCard  
VISA  
OFS WeatherFAX

Name \_\_\_\_\_  
Address \_\_\_\_\_  
Phone \_\_\_\_\_



# THE JAPAN RADIO CO. NRD-535

## THE NEXT GENERATION IN HIGH-PERFORMANCE HF RECEIVERS

Once again JRC breaks new ground in shortwave receiver design. The new NRD-535 has all the features SWLs and amateurs have been waiting for. General coverage from 0.1 to 30 MHz in AM, USB, LSB, CW, RTTY, FAX and Narrow FM modes. Advanced ECSS operation for phase-lock AM reception. Variable bandwidth control (BWC). Tuning accuracy to 1 Hz possible with direct digital synthesis. 200 memory channels with scan and sweep operation. Triple Superheterodyne receiving

system. Superb sensitivity, selectivity and image rejection. Dual-width noise blanker eliminates impulse noise. Squelch, RF Gain, Attenuator, AGC and Tone controls. Optional RTTY demodulator available. 24 hour clock/timer. Easy to read vacuum fluorescent display with digital S-meter. AC and DC operation. Plus the most comprehensive computer interface found on any radio to date. Call or write today for a full color brochure, price list and dealer information.



*Japan Radio Co., Ltd.*

MAIN OFFICE: Akasaka Twin Tower (Main), Akasaka 2-chome, Minato-ku, Tokyo 107, JAPAN  
Tel.: (03) 584-8836 Telex: 242-5420 JRCTOK J

IN U.S.A.: 430 Park Avenue (2nd Floor), New York, NY 10022  
Tel.: (212) 355-1180 FAX: (212) 319-5227 Telex: 961114 JAPAN RADIO NYK

CIRCLE 31 ON READER SERVICE CARD

## Listen, Up In The Sky!

With the space program gaining more and more momentum, it was time for a comprehensive and updated NASA monitoring guide to appear, covering HF, VHF, and UHF frequencies. *Monitoring NASA Communications*, by Anthony R. Curtis, K3RXX,

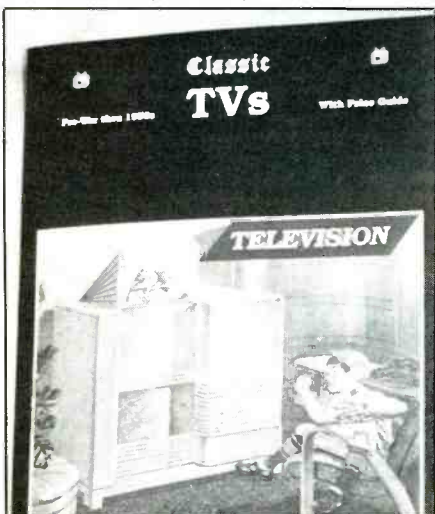

tackles the job in a frequency-filled 100-page book that provides an enormous amount of information.

Tony covers a wide range of things to monitor, including signals from communications satellites, weather satellites, navigation satellites, the Space Shuttle program, space probes and telescopes, and other miscellaneous pieces of cosmic hardware, plus the terrestrial equipment used for keeping in touch.

More than just a straight frequency listing, the book explains the radio systems in use for each of the various types of satellites and probes that you can hear. Past and future launch dates, orbits, and other useful information is provided. There's a lot of excellent information on how to monitor NASA, such as the types of receivers and antennas that produce the best results.

At the back of the book, there's a huge 15-page frequency-sort of all known NASA frequencies between 2 MHz and 400 GHz. This includes uplinks and downlinks, and gives information on locations, transmission modes, etc. Ham radio relays of Space Shuttle comms are included in this data.

A concise compilation of communications data that will provide lots of the latest useful information for all HF monitors, scanner owners, and experimenters.

*Monitoring NASA Communications*, is \$14.95, plus \$3.50 for UPS shipping to addresses in USA (sent by 1st Class mail to AK, HI, PR, VI, GU, military addresses, and Canada). Order it from CRB Research Books, Inc., P.O. Box 56, Commack, NY 11725. Residents of NY State, please add \$1.48 sales tax.

## Engineer's Notebook

Those among our readers with an interest in the technical aspect of electronics equipment should recognize Forrest Mims' name. He's written countless magazine articles and many books dealing with circuits.

Forrest's newest book is entitled *Forrest Mims Engineer's Notebook*. Earlier versions of the *Engineer's Notebook* were written by Forrest for Radio Shack, becoming best sellers. This latest, completely revised and updated edition, is from HighText.

Essentially, it's a workbook of IC applications, with schematics. There is additional information relating to tips, parts substitutions, and (often) Forrest's personal observations regarding how the devices performed when he worked with them.

The circuit designs provided in this 155-page book are numerous and diverse. The range from simple digital logic networks and amps to rhythm pattern generators, tone decoders, temperature sensors, digital to analog converters, counters, and many other useful ideas. IC pin numbers are included, supply voltages are indicated, values of other components are given. A listing of parts sources

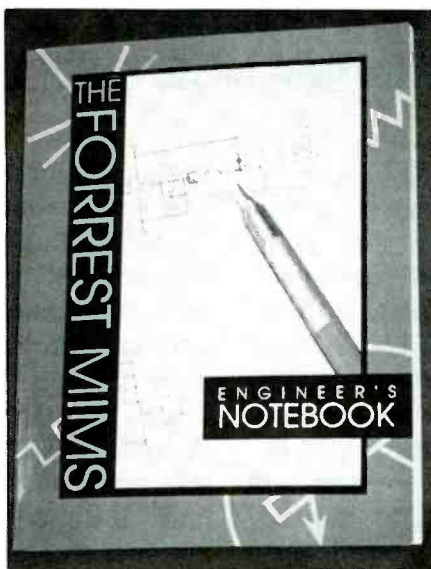

is included in the front of the book. At the back of the book, there's a complete index.

Here's a real hands-on book for the tinkerer, filled with all sorts of interesting and useful circuits. The book is \$14.95. It comes from HighText Publications Inc., 7128 Miramar Rd., Suite 15, San Diego, CA 92121.

## Hooray For The Hallicrafters Model 509

TV sets are part of our throw-away society. As you drive down the street, it's not uncommon to see gutted old sets put out with the garbage cans. The thing is that in years to come, those old TV sets will interest col-

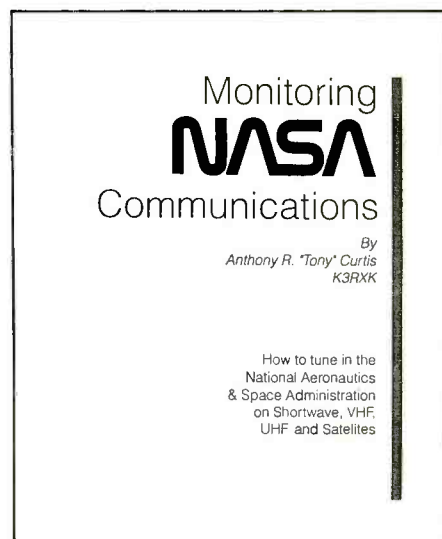

lectors. That is, those few that manage to survive.

Right now, TV sets from the late 1940's and the 1950's are being sought by people who collect, buy, and sell this equipment. If you have an Andrea Model 1-F-5, or a GE Model HM-225 gathering dust in the garage, they're worth \$3,500 or more. Other sets are worth just as much. Most TV sets from those years are still worth well over \$100, even if they aren't super-rare. Of course, they aren't expected to be in showroom mint condition, but they sure won't bring top dollar if they've been left sitting out in the rain for the last 35 years.

A fine reference source for those interested in learning more about such things is *Classic TV's*, by Scott Wood. This slick 83-page book covers TV sets made from pre WWII days through the 1950's. It is loaded with beautiful color photos of classic TV sets, each identified by make, model, and year of manufacture, also giving its present collector average-condition value. The front of the book reproduces numerous early print ads for TV receivers, and also provides the names and addresses of several collectors who buy, sell, trade, and repair antique TV sets.

*Classic TV's* is available at \$16.95, plus \$2 for shipping and handling, from L-W Book Sales & Publishing, P.O. Box 69, Gas City, IN 46933. Pay by check, Visa, Master Card, or order it C.O.D.

## Hello - Buzz-Buzz - Name is - Buzz Buzz

The only thing worse than hearing that important news flash over the AM radio is trying to hear it and not being able to because of buzzing noises that make copy impossible. Does your shortwave receiver become too noisy to use when the vacuum cleaner is turned on? Or do patterns and rhythmic dark bars sometimes flash on your TV screen?



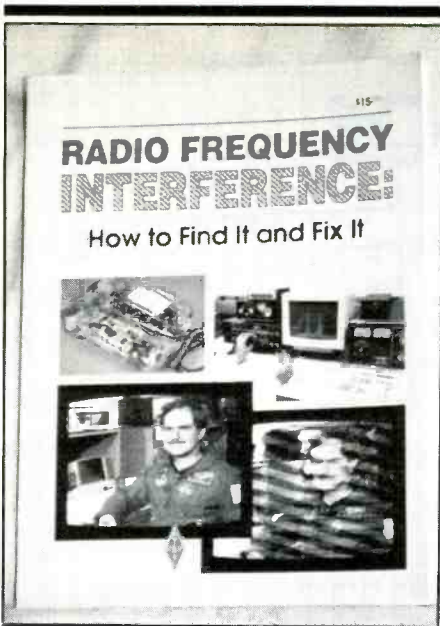

Does your automatic garage door opener operate according to the dictates of some mysterious unseen force? Does your scanner stop scanning when you switch on your computer? Does a neighbor's CB or ham transmitter come through on your telephone, answering machine, or VCR? Does your touch-controlled lamp go on or off by itself?

These, as well as many other common annoyances are usually the result of interference from radio frequency (RF) signals. RF interference doesn't always come from radio transmitters, it can also be generated by power lines, motors, electric blankets, computers, vehicles, TV sets, VCR's, telephones, stereos, aquarium pumps, defective light bulbs, fluorescent lights, and many other things. The trick is locating the source of the interference (no easy trick for the uninformed), then taking specific steps to stop the interference from being radiated, or at least from messing up the operation of your stuff.

What you eventually find out is that sometimes interference isn't always a clear cut case of dropping the blame at the feet of only one offender. Something could be at fault by radiating the offending RF, but your equipment could also share the blame by interacting with the incoming signal, or else it has a design or manufacturing defect (or a malfunction) that makes it unable to reject the interference it is now experiencing.

All of these topics are amply explored in, *Radio Interference: How to Find It and Fix It*, a book put out by the ARRL. This large book is fully illustrated with photos, diagrams, charts, tables, and schematics. The text is informative, to the point, and well-rounded, covering the subject in considerable depth. While not highly technical, if you're a person who thinks an ohm is an Englishman's residence, then you're not quite ready to comprehend some of the valuable information presented here.

This useful book could solve your interference problems. It is \$15.00, and may be ordered from the American Radio Relay League, Newington, CT 06111.

## ICOM™ R7000 Sweeping 1300 Channels/Min.

**DELTA COMM™ 1.04** gives you a custom interface and optimized software that will not just control but will maximize the potential of your R7000. Spectrum log at speeds in excess of 1300 channels/min. while automatically generating a histogram of frequency/activity. Advanced priority channel monitoring and program control, by channel, of remote tape recorders during scanning. Here are a few (there are many more) examples of the advanced features DELTA COMM has to offer:

- Birdie log during frequency search automatically characterizes your R7000, then locks out those frequencies.
- Auto histogram and scan file creation during spectrum log.
- Scan file channel lock-out feature allows scanning around channels without removing that frequency from database.
- Resume scan and maximum monitor values unique on each channel scanned.
- Each frequency within a scan file has an area (40 characters wide) for channel information.



- Auto frequency detection and storage during search and spectrum log.
- User friendly installation program reduces need for DOS knowledge.
- Full support of serial ports COM1-COM4.
- On-screen HELP reduces need to refer to user manual.
- REQUIREMENTS: MS-DOS microcomputer with minimum 512K memory. DELTA COMM's performance is proportional to baud rate setting, style of display card and type of computer used.

**\$299** Incl. Ext. Interface & Components for Cabling.  
Check, MO, VISA or MASTER  
Accepted + \$4 for S&H  
(WI Res. Add 5% Sales Tax)



**DELTA RESEARCH**  
PO Box 13677 • Wauwatosa, WI 53213  
FAX or Phone Weekdays (414) 353-4567

CIRCLE 2 ON READER SERVICE CARD



## World's Most Powerful CB and Amateur Mobile Antenna\*

**Lockheed Corp. Test Shows  
Wilson 1000 CB Antenna Has  
58% More Gain Than The  
K40 Antenna (on channel 40).**

In tests conducted by Lockheed Corporation, one of the world's largest Aerospace Companies, at their Rye Canyon Laboratory and Antenna Test Range, the Wilson 1000 was found to have 58% more power gain than the K40 Electronics Company, K40 CB Antenna. This means that the Wilson 1000 gives you 58% more gain on both transmit and receive. Now you can instantly increase your operating range by using a Wilson 1000.

**Guaranteed To Transmit and Receive  
Farther Than Any Other Mobile  
CB Antenna or Your Money Back\*\*  
New Design**

The Wilson 1000 higher gain performance is a result of new design developments that bring you the most powerful CB base loaded antenna available.

### Why Wilson 1000 Performs Better

Many CB antennas lose more than 50% of the power put into them. The power is wasted as heat loss in the plastic inside the coil form and not radiated as radio waves.

We have designed a new coil form which suspends the coil in air and still retains the rigidity needed for support. This new design eliminates 95% of the dielectric losses. We feel that this new design is so unique that we have filed a patent application on it.

In addition, we use 10 Ga. silver plated wire to reduce resistive losses to a minimum.

In order to handle higher power for amateur use, we used the more efficient direct coupling method of matching, rather than the lossy capacitor coupling. With this method the Wilson 1000 will handle 3000 watts of power.

### The Best You Can Buy

So far you have read about why the Wilson 1000 performs better, but it is also one of the most rugged antennas you can buy. It is made from high impact thermoplastics with ultraviolet protection. The threaded body mount and coil threads are stainless steel; the whip is tapered 17-7 ph. stainless steel. All of these reasons are why it is the best CB antenna on the market today, and we guarantee to you that it will outperform any CB antenna (K40, Formula 1, you name it) or your money back!

\*Inductively base loaded antennas  
\*\*Call for details.

### Lockheed - California Company

A Division of Lockheed Corporation  
Burbank, California 91520

Aug. 21, 1987

Wilson Antenna Company Inc.  
3 Sunset Way Unit A-10  
Green Valley Commerce Center  
Henderson, Nevada 89015

Subject: Comparative Gain Testing of Citizen's Band Antennas  
Ref: Rye Canyon Antenna Lab File #870529

We have completed relative gain measurements of your model 1000 antenna using the K-40 antenna as the reference. The test was conducted with the antennas mounted on a 16' ground plane with a separation of greater than 300' between the transmit and test antennas. The antennas were tuned by the standard VSWR method. The results of the test are tabulated below:

FREQUENCY (MHZ)	RELATIVE GAIN (dB)	RELATIVE POWER GAIN (%)
26.965	1.30	35
27.015	1.30	35
27.065	1.45	40
27.115	1.60	45
27.165	1.50	41
27.215	1.60	45
27.265	1.75	50
27.315	1.95	57
27.365	2.00	58
27.405	2.00	58

**58%  
MORE  
POWER GAIN  
THAN THE  
K40**

**CALL TODAY**  
TOLL FREE: 1-800-541-6116  
FOR YOUR NEAREST DEALER  
**Wilson 1000**  
Available in Black or White

Roof Top Mount ..... **59<sup>95</sup>**  
Trunk Lip Mount ..... **60<sup>95</sup>**  
Magnetic Mount ..... **79<sup>95</sup>**  
Wilson 1000 Trucker ..... **59<sup>95</sup>**  
**DEALERS** Exclusive dealer areas still open

**Wilson**  
ANTENNA INC.  
1181 GRIER DR., STE. A  
LAS VEGAS, NV 89119

# Get ESM Out Of The Closet

## Electronic Support Measures: What Do You Know About Them?

BY WILLIAM R. BIGAS

Commanders of surface ships and submarines are overloaded with information that must be assimilated into useful tactics. Passive electronic warfare (EW) sensors (called Electronic Support Measures, or ESM) are often misunderstood as radio room cloak and dagger activities performed by specialists. But ESM is not that mysterious. Modern systems can extend the ship's weapon engagement range without revealing ship's intentions. ESM may be employed for antiship missile targeting against over-the-horizon targets. In fact, a series of tactical doctrine publications, the NWP-64 series, has been developed to provide over-the-horizon targeting (OTH-T), strike warfare tactics, and weapon employment guidance.

Detection ranges as a function of emitter, platform, ESM, and propagation conditions are illustrated for representative tactical situations. Typically, a surface contact can be detected and identified using only ESM at a range of 45-60 nautical miles, often beyond the range of sonar and clearly beyond the range of active radar. Differences between surface-ship and submarine ESM are noted. Wide-open or high-probability-of-intercept ESM designs are described and shown to have both advantages and disadvantages relative to conventional (narrowband) ESM. Problems associated with target classification and data with on- and off-board sensors are discussed in the context of over-the-horizon targeting.

ESM is a passive electronic warfare activity designed to support the ship's missions and operations by spectrum surveillance, receipt and analysis of signals, direction-finding (angle or arrival referenced to ship's heading or true North), signal classification and identification, and in some cases, exploitation of signal information. Physically, an ESM system consists of mast-mounted antennae and usually one to two racks of electronics operated by a dedicated sensor operator or remotely controlled by the ship's combat system. Microwave ESM in the gigahertz frequency range is mostly concerned with radar and radiating weapons, such as surface-to-air missiles and missile seekers. Until recently, ESM was mistakenly called ECM (elec-

tronic countermeasures), which today is synonymous with active jamming and chaff.

Microwave ESM deals primarily with signal externals such as radio frequency and pulse repetition frequency. Submicrowave ESM working in the high frequency, very high frequency, and ultra high frequency range, normally called tactical communications intelligence, intercepts communication—not radar—signals to extract both the intelligible information carried by the signal and the frequency and direction of arrival to track and associate signals. Since a human operator, normally a linguist, is required to copy and exploit non-cooperative communications, tactical communications intelligence is highly specialized, costly and not as widespread in naval use as its microwave equivalent.

This article concentrates on the tactical capabilities and limitations of microwave ESM presented from the viewpoint of command level personnel and users. ESM systems built for the U.S. Navy today are now quite mature in terms of technical state of development and logistics. Nevertheless, what is often confusing to the user is that there are several different technical configurations in use today, with dif-

ferent performance features that influence tactical use. Table 1 lists the primary factors. The upper half of the table shows tactical attributes while the lower half describes the technical factors that determine the tactical attributes.

The ideal ESM system has high sensitivity for long range detection, fast intercept speed for threat reaction, and excellent direction-finding accuracy for reliable tracking and weapon designation. Unfortunately, currently deployed ESM systems excel in only some of these attributes. The user ultimately must select the ESM system with characteristics most suited to his application. Hence, the AN/SLQ-32 Bands 2 and 3 designs are optimized for antiship missile defense, while the Band 1 Upgrade is more closely allied to long-range search and targeting.

Submarine ESM differs from surface ship ESM because only a few physically small antenna types are compatible with submarine operation: omnidirectional bicones, arrays of spirals, and rotating dishes. These antennas differences generally reduce the attainable sensitivity and DF accuracy of submarine ESM but have little effect on intercept speed

**Table 1**  
U.S. Navy Shipboard ESM Systems

	RWR	AN/SLQ-32	Upgraded	AN/WLR (H)
	Type	(Band 2 and 3)	AN/SLQ-32 (Band 1)	AS-899
Sensitivity*	Low	Medium	High	High
Intercept Speed	Fast	Fast	Moderate	Slow
(mainbeam-only signals)				
DF Accuracy	Fair	Good	Excellent	Good
Receiver Type	Detector (DLVA)	Discriminator (IFM)	Superhet	Superhet
Instantaneous Bandwidth	Full	Full	Limited	Limited
Antenna Type	Spirals (amplitude monopulse)	Phased Arrays (multi-beam)	Spirals (phase/amplitude monopulse)	Rotating Dish (high gain)
Instantaneous Field of View	Full	Full	Full	Limited

\* Sensitivity is defined as the minimum detectable received signal strength at the ESM antenna, measured relative to a milliwatt and expressed as "dB below a milliwatt" or "dBm." For discussion purposes, low sensitivity is in the range of -40dBm, medium sensitivity in the range of -60 dBm, and high sensitivity in the range of -80 dBm.

**Table 2**  
**Tactical Significance of Microwave ESM**  
**Capabilities**

- Can detect radar signals from hostile and friendly forces at long range.
  - Normally well beyond the horizon.
  - Provides "situation awareness."
- Can classify signals and identify specific radar type.
  - Friend or foe, type of platform.
  - Radar operating mode provides tip off to tactical intent.
- Direction Finding (angle location) provides a means of:
  - Targeting weapons and other sensors.
  - Associating signals with other sensor data (especially radar) for "data fusion."
  - Tracking emitters.
  - Geolocating signals over time if either own ship or contact is moving.

**Limitations**

- Will not work at all if radars are not operating (e.g. emission control).
- Unable to measure range directly.
  - But does measure signal strength for "ball park" estimation.

and threat reaction.

The officer in command wants to know with confidence:

- What and where are the threats within his sphere of influence—(100-250 nautical-mile radius and growing.)
- What are the threats' intentions at this time—status and current mode of operation.

These operational desires translate into near-real-time surveillance accurate direction-finding, and long-range detection which in turn require a wide-open, high-probability-of-intercept design having both high sensitivity and angular accuracy. Costly multi-channel systems, such as frequency-channelized phased arrays, can in theory approach the ideal system in performance, but to date these have never been realized in a cost effective manner.

Table 2 summarizes the tactical capabilities and limitations of microwave ESM for surface ships and submarines.

Microwave ESM detection ranges against radar can be easily predicted knowing the technical characteristics of the ESM and radar and assuming free-space propagation conditions. The key to effective ESM utilization, however, is knowing how well it performs on your ship at sea with realistic—non-free-space—propagation conditions.

The U.S. Navy has developed a significant tool for accurately predicting propagation conditions for both radar and ESM equipment. Called IREPS, for Integrated Refractive Effects Prediction System, the Navy system computes propagation losses and radiation patterns using stored data bases and key physical variables such as surface ducting which enhances the detection range to low-altitude targets by trapping the rays in a layer.

Other computer-based propagation models exist that do a good job of predicting realistic non-ducting conditions. These static models cover a vast majority of conditions at sea, though not with the specific accuracy of IREPS. But, since enhanced propagation is an unreliable condition on average, it is best that the user design his tactics around more

conservative ranges such as predicted by conventional methods.

Figure 1 shows the detection ranges of the three classes of ESM systems (previously described in Table 1) against three generic warship radars covering the frequency range from ultra high frequency to X-band. These detection ranges are keyed by reliability at sea. Note that a high-sensitivity system is needed for organic over-the-horizon targeting to fully exploit the capabilities of the Harpoon missile.

The requirement for direction-finding (DF) accuracy of organic targeting is related to the uncertainty area that the missile seeker must search through to acquire the target. Using simple geometry, a one-nautical-mile certainty would require a 1° DF accuracy at 50 nautical-miles; a 5-nautical miles uncertainty would require a 6° accuracy, and so on. Ob-

viously, the better the DF accuracy, the more selectively the missile can be targeted.

Reconnaissance from offboard sources plays a critical role in over-the-horizon targeting. Availability and timeliness of this data is an issue that must be considered. Resources that can be controlled by the surface task force directly may include helicopters, such as SH-60B Seahawks which are equipped with the AN/ALQ-142. This airborne ESM system feeds a parent AN/SLQ-32 system on the ship. Helicopter-borne ESM can be used for triangulation with ship's own ESM data without revealing launch intentions.

Submarines at periscope depth use ESM for quick, reliable detection of anti-submarine warfare threats, and potentially also for long-range OTH targeting for weapons such as encapsulated Harpoon. Submarine operational requirements sometimes result in a hybrid ESM system technical approach that contains both wide-open, high-probability of intercept receivers and narrowband receivers, fed by small antennae. The current trend for OTH targeting is away from rotating DF antennas such as the AN/BLA-4 to phase interferometers, such as the AN/BLD-1. Interferometers may improve DF accuracy and intercept speed due to wider field of view, but this is at the expense of some detection range and increased cost and complexity.

The submarine antenna at periscope depth is exposed only 2 to 3 feet above sea level. On surface ships, in contrast, ESM antennas are mounted from 30 to 90 feet high. The low antenna height for submarines decreases the ESM detection range by 20-50% (a function of frequency) relative to a surface-ship's ESM system having equivalent sensitivity. This loss of detection range results primarily from cancellation of direct-path signals by reflected rays from the sea surface. Rough seas may

**Figure 1**

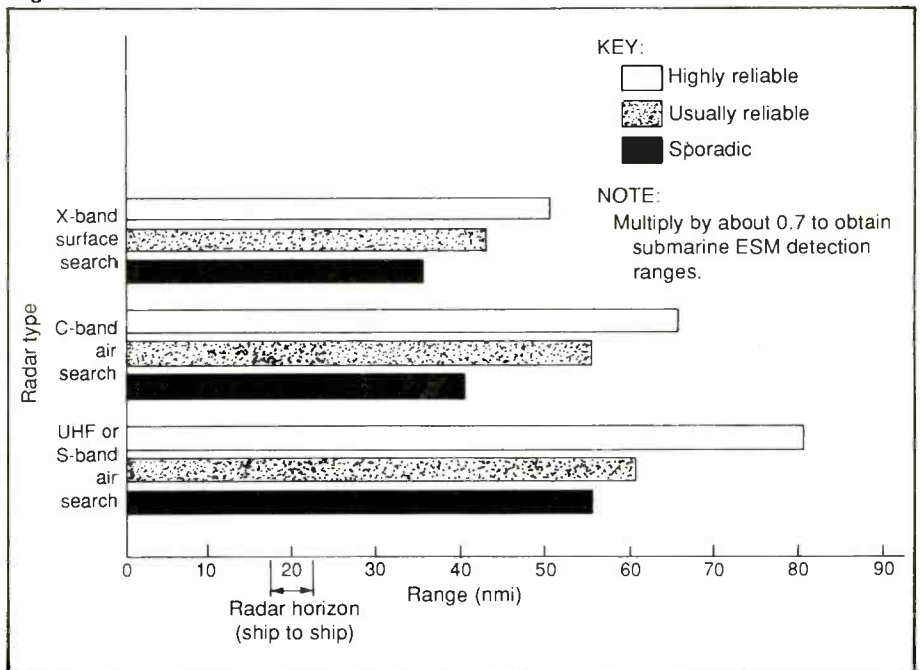

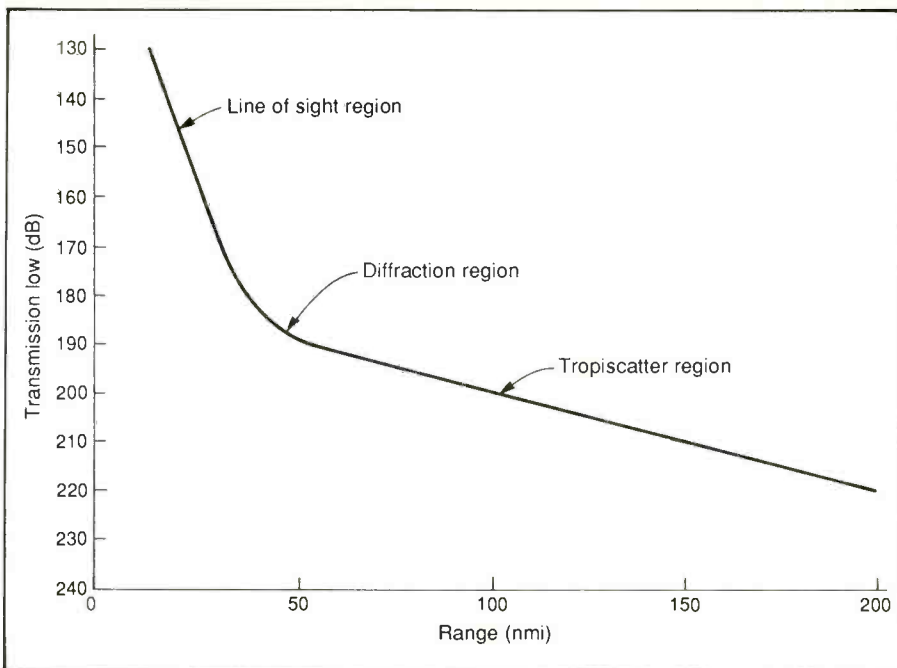

Figure 2

actually improve the ESM detection range from a submarine versus smooth seas due to diffuse, rather than specular, reflection of rays from the sea surface.

The ESM received-signal strength equals the radar's effective radiated power (ERP) minus the propagation loss. The maximum

propagation loss attainable therefore equals the ERP minus the ESM sensitivity. Tolerable propagation losses for microwave ESM are in the area of 160 to 180 decibels (dB) (e.g. 100-120 dB emitter ERP and -60 dB ESM sensitivity). If ESM sensitivity is increased by 30 dB or more, however, greatly extended detection ranges can be obtained through forward tropospheric scattering. Tropospheric scattering is a weak but fairly reliable over-the-horizon phenomena in the UHF to S-Band frequency range. This phenomena can extend microwave ESM capabilities out to the range of long-range antiship cruise missiles such as the Tomahawk. Figure 2 shows an example path loss chart for a radar frequency of 850 megahertz in the mid-Pacific Ocean area. Including long-term and short-term fading effects, losses are less than shown 90% of the time for a transmitter height of 60 feet and a receiver height of 30 feet.

If, for example, a microwave ESM system could be deployed with a sensitivity of -95 dBm, an air-search radar could be detected at 200 nautical miles or more. Is this feasible? For surface-ship ESM, the answer is "yes" and for submarines, "maybe." What is required is a DF antenna having at least some gain at low frequencies, and specialized (very narrowband) digital signal processing designed to intercept the spectral lines of coherent radar signals. Experimental work being performed currently on this subject tends to verify these theoretical predictions.

An ESM system is tactically only as good as the quality of its library data. But generating and maintaining accurate library data is not an insignificant problem. For example, modern radars may have ten or twenty modes of operation, each of which must be accurately characterized as a library entry. Libraries of 2,000 and even up to 10,000 modes—are now being used in tactical systems.

Unfortunately, with the proliferation of new radars and the continued use of older radars all over the world, more and more overlaps in parameters are occurring, resulting in ambiguities in identifying signals. Methods developed to handle this problem include confidence ranking of potential identities using statistical measures or *a priori* knowledge, single or multiple emitter-to-platform correlation techniques, and/or fusion of multiple types of sensor information. Data fusion, as this latter procedure is called, generally relies on correlating multiple sensor information together using kinematic data (e.g., target bearing or location) and attributes (e.g. radar types) to arrive at an identification and to facilitate tracking and prediction. Once again, the need for high DF accuracy in the ESM system is stressed.

On- and off-board data may arrive at different times from different sources with varying quality. Robust computer algorithms, including artificial intelligence approaches, are continuously being conceptualized and tested to deal with fusion problems. Multiple-sensor, multiple-target tracking is a complex subject and implementation depends on the approach towards centralization—observation processing; or distribution—sensor level tracking of processing. The evidential reasoning method, that is a generalization of classical Bayesian theory, seems particularly suited for fusion of ESM and radar data.

The Navy mission display system is a computerized planning system for targeting the Tomahawk cruise missile. Installed on battleships, aircraft carriers, and at shore-based fleet headquarters, intelligence information is automatically updated via a secure communication system, operating in a network configuration.

Three major operational roles for ESM have clearly emerged:

- Defensive quick-reaction threat warning.
- Long-range situation awareness.
- Offensive weapons initialization/targeting at over-the-horizon ranges.

The importance of ESM as a long-range target acquisition, classification and tracking sensor for over-the-horizon operations is increasing as confidence in its capabilities is obtained by command users. Realistic tactical training is key to the smooth application of ESM resources. Rules of engagement may even be modified as higher levels of ESM proficiency are obtained.

Microwave ESM is fairly straightforward. The capabilities and limitations are well known to experienced users. Nonetheless, the ideal microwave ESM system has yet to be fielded, and complexities in the evolving signal environment are forever stressing the capabilities of these systems. We should not let our diligence in EW and ESM decline, even in these times of tight budgets. As the old adage goes: "He who plays the EW game last, will win."

Reprinted from *Proceedings* with permission; Copyright © (1991) U.S. Naval Institute.

## The Toughest Little "GUNN" in Town!

**3 + 3 STAR**

UPS SHIPPABLE

**Other Models & Sizes Available in 10 or 11 Meters**

MasterCard VISA DISCOVER

Call or send \$2.00 for Complete Catalog and Pricing of Antennas.

Route 1 - Box 32C, Hwy. 82  
Ethelsville, AL 35461  
**(205) 658-2229**  
**FAX: (205) 658-2259**  
Hours: 10 am - 6 pm (CST)  
Monday - Friday

**DEALER INQUIRIES, PLEASE CALL**

# Scan Delay For The R-7000

*It Is A Simple Addition To This Worthwhile Receiver*

BY RONALD M. VACELUKE, W9SEK

The ICOM R-7000 is a worthwhile upgrade to a good receiver for monitoring wide band of VHF and UHF frequencies. Besides manual tuning, it has provisions for several modes of scanning and it is in this type of service that it has a design omission. That flaw shows up when the "Scan Delay" switch is in the "Off" position. When in this position, the receiver will stop scanning when a signal is received and will stay on that frequency until the signal disappears. It is at this moment that the design omission shows up because the instant that the signal goes, the receiver starts to scan again without the pause all other "normal" scanners have. This can be very disconcerting when you are listening to one side of a discourse and the receiver starts scanning again when the transmitting station stops for a reply from the other party. Even worse is listening to a mobile station that might have flutter and have the receiver start scanning again in the middle of a transmission because the signal faded out for the briefest of moments. The only way to overcome this was to turn the scan function off when a desired signal was encountered and re-set the scan function when ready to listen to something else. Having gotten tired of this hands on method of scanning, I decided to do something about it.

## Circuit Description

A study of the schematic shows that a "stop" scanning signal is generated on the "Main Unit" circuit board by transistor Q11 and Q10. This "stop" signal goes to the "Logic Unit" circuit board to instruct it to stop scanning when this signal is approximately 2.5 volts or greater. When this voltage drops down to a lower level (around 0.0 V in this case) the logic circuitry begins the scanning process again.

What is needed is an artificial or added stop signal that will replace the signal generated by Q11. This added stop signal must remain for a predetermined length of time after the original stop signal drops off. This delayed stop signal must have the same duration no matter how long or how short the transmission is that we have been listening to. The device chosen to perform the task is a 74LS123 dual re-triggerable mono-stable

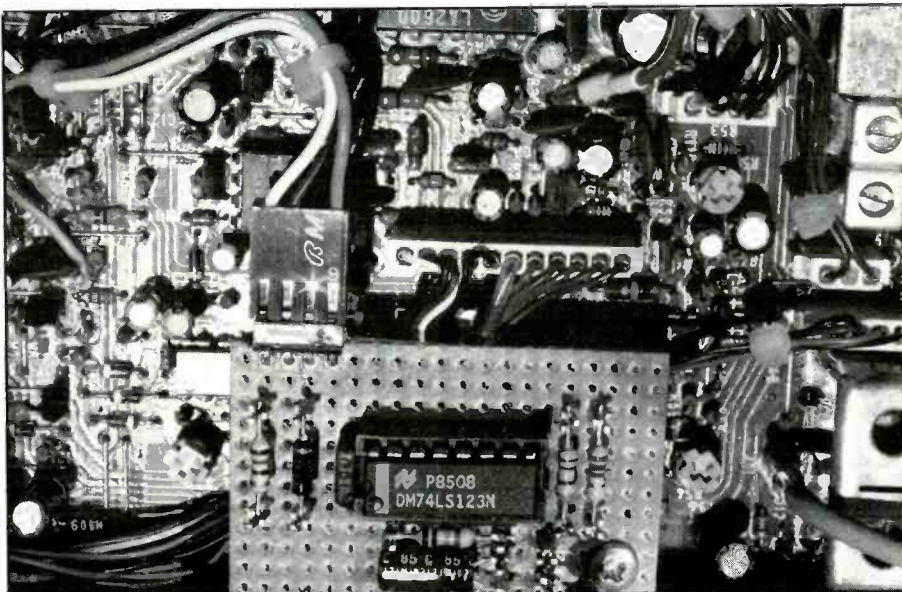

Photo 1 - The added circuit board installed in R-7000.

multivibrator (only  $\frac{1}{2}$  is used in our circuit). A 2N3904 transistor was added as a buffer amplifier. The trigger pulse for the LS123 is generated by Q10. The new delayed stop signal is combined with the stop signal of Q11 through an OR gate made up of two diodes. One of these diodes, Da, is mounted on the Main Unit circuit board and the other is on the new circuit board which holds the remaining circuitry.

## Construction

I built my new circuit board on a piece of  $2" \times 1\frac{1}{32}"$  perforated Vector board. A 16 pin wire wrap socket is used for the LS123 and wire wrap terminals are used for the other components. I chose to use a four pin connector on the board so that easy connect or disconnect was possible when needed; however, connectors are not mandatory. If a connector of the type shown here is used, I strongly recommend that eyelets be swaged into the board for the connector pins to go through and be soldered to. This is the only practical way that this device can be firmly anchored. A hole must also be drilled into a corner of the board so that it can be

mounted to the receiver using a M3-20 screw and a  $\frac{1}{2}"$  long spacer.

Wiring can be done using wire wrap or other point to point methods. When this board is mounted above the main circuit board in final assembly, there is not an abundance of clearance in some places. For this reason, when wire wrapping, use only a couple of turns around each post and then solder the wrap. The posts must then be cut as short as possible. There is nothing critical about wiring this circuit, just be sure that you are accurate and shorts are averted. Although this is a simple circuit, as circuits go, to some less technically inclined persons it may seem a formidable task. To these persons I recommend finding a technician to help you out. Your local radio club might suggest someone capable of assistance.

The time delay is determined by Ct. The time delays shown for the values given are those I obtained with the capacitors I had available. Because of component tolerances, you may get slightly different time delays but should not deviate much from those shown. I personally chose the 3 second delay for my receiver.

P/O R-7000 MAIN UNIT BOARD

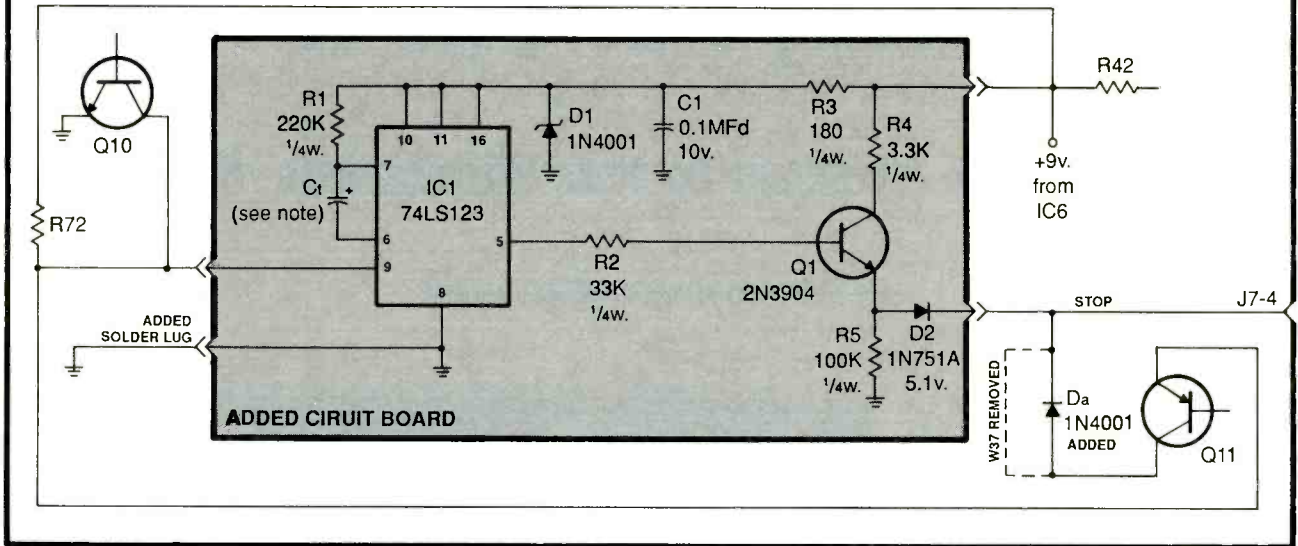

NOTES:

1. Ct = 22 MFd  $\cong$  2.5 sec delay  
 33 MFd  $\cong$  3.0 sec delay  
 47 MFd  $\cong$  4.0 sec delay
2. 1 ea. = GC Electronics # 41-084, 4 pos. header (male)  
 GC Electronics # 41-124, 4 pos. connector (female)  
 Vector board 2" x 1<sup>11</sup>/<sub>32</sub>"  
 M3-20 screw  
 1/2" spacer drilled to clear M3 screw  
 Solder lug  
 Vector T49/Klipwrap terminals

**Installation**

After disconnecting the power and all other connections to the receiver, remove all the retaining screws (qty 18) which hold the top and bottom covers of the receiver. Next remove the top cover slowly and unplug the speaker lead from the top board and then remove the bottom cover. Place the receiver so that you may conveniently and comfortably work on the Main Unit circuit board. This is the board on the left side of the receiver. Unplug all connectors from the board (note that some leads are permanently soldered—do not remove these!) as

well as the six mounting screws. Note: All parts are clearly marked on the circuit board. In regard to parts location on the Main Unit board, the top of the board is the same as the top of the receiver, the right side of the board is toward the front of the receiver, etc.

Locate a jumper wire designated W37. It is located near the right middle end of the board, just to the left of trimmer potentiometer R124. Unsolder and discard. Now install and solder Da. This diode is mounted vertically with its anode (un-banded) end in the hole closest to the top of the board. The cathode (banded) lead will be bent over and

go to the bottom hole. The board may now be re-installed on the chassis using 5 screws. Do not replace the upper middle screw. Install a solder lug under the mounting screw of voltage regulator IC6 which is on the heat-sink, bottom, near right side of the board.

The four leads that will connect the delay board will be wired next. If a connector is used, wire it in first. In any event connect the wires as follows: (See photo 2) Ground lead to the previously installed solder log; plus 9 volts to resistor R42 which is above and to the right of IC6. The connection is made to R42's left lead (the one closest to IC6). (See (Continued on page 74)

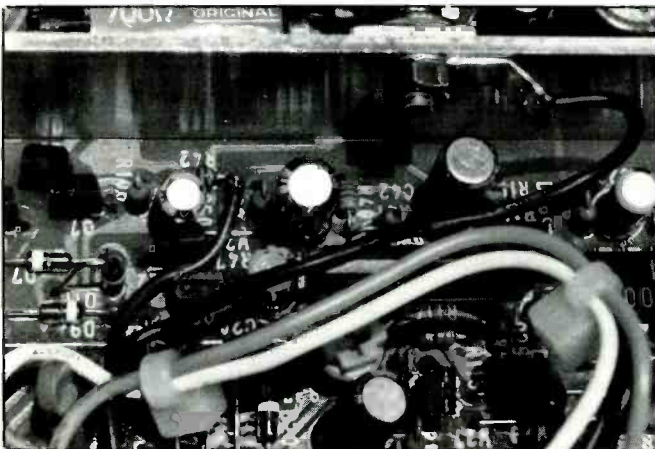

Photo 2 - Showing power lead connected to R42 and ground lead on newly installed solder lug.

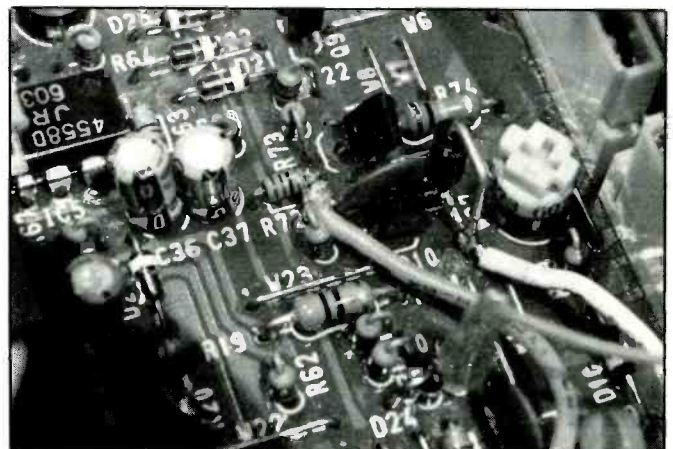

Photo 3 - Showing input lead on R72 and output lead on added diode Da.

# HOW I GOT STARTED

**W**e invite our readers to submit, in about 150 words, how they got started in the communications hobby. Please send them type-written or otherwise easily readable. If you have a photo of yourself, please include it with your story. We can't return or acknowledge material, whether or not it is used. Your story need be submitted only once, we'll keep it on file to consider it for future issues. All submissions become the property of *Popular Communications*.

Entries will be considered on the basis of their story being especially interesting, unusual, or even amusing. We reserve the right to make any editorial changes we deem necessary to improve style or grammar.

Each month, we will select one winner. The author will receive a 1-year gift subscription (or subscription extension if already a subscriber) to *Popular Communications*.

Address all entries to How I Got Started, *Popular Communications*, 76 North Broadway, Hicksville, NY 11801.

## Our Winner For July

This month, our winner is Billy B. Johnson,



Here's Billy B. Johnson, WB5RYB, of Crossett, Arkansas.

son, WB5RYB, Crossett, Ark. He told us:

"When I was 8, my father gave me a Zenith table model radio. Although I used it for listening to *The Shadow*, *Gang Busters*, and other programs, it also got me interested in roam-

ing the dial for distant stations.

"In high school, I built a crystal set, then a few simple shortwave receivers. When I was in college, I had a Hallicrafters S-85 which opened the way for real shortwave listening and the thrill of hearing exotic DX. That's when I decided that ham radio might be fun, and I might study for the Novice license.

"The unexpected hitch in that plan came when I met Ruth Anne, a distraction from which I have never fully recovered. We have been married for 26 years.

"When CB became popular in the 1970's, my interest in radio was rekindled. In 1976, I finally went out and got my 2-year non-renewable Novice ham ticket (WN5RYB), and I built a Heathkit HW-16 transceiver. I had so much fun operating that I almost forgot about upgrading before my license expired.

"Presently, I hold an Amateur Extra Class license (WB5RYB). I like to chase DX on 40 and 15 meters, 'phone and CW. I still enjoy SWL'ing, and have also begun listening for mediumwave DX. Radio of all kinds has provided many hours of enjoyment for the past 40 years."

## DSP from JPS

Hear how Digital Signal Processing can improve your reception!

Use our new NF-60 to  
knock out ALL  
heterodynes and tune-ups.

Remove MULTIPLE heterodynes, (tones and whistles) and tune-ups with the new NF-60 automatic DSP audio Spectral Notch Filter. The unit connects between the receiver audio output and the speaker. Contains a built-in speaker amplifier. Knocks out TUNE-UPS, CW, or RTTY tones.



NF-60

Use our NIR-10 if you're  
troubled by more than just  
heterodynes.

Reduce white/pink noise, power line noise, ignition noise AND multiple heterodynes with the NIR-10. Unit includes variable BANDPASS filter mode and automatic NOTCH filter mode. Made possible by real time Digital Signal Processing (DSP) using a 40 MHz DSP chip.

NF-60 Introductory Price: \$149.95.

For 115VAC to 12VDC Adapter add \$12. Charge to MasterCard or Visa. Allow 1 week for personal checks. COD additional. We pay surface shipping in the Continental United States. NC residents add 6% sales tax.

NIR-10: Still \$395.



JPS Communications, Inc.  
P.O. Box 97757 Raleigh, NC 27624

TOLL FREE ORDER LINE 1-800-533-3819  
Technical Info 1-919-790-1048 FAX 1-919-790-1456

# SCANNING VHF/UHF

BY CHUCK GYSI, N2DUP

## MONITORING THE 30 TO 900 MHz "ACTION" BANDS

Summertime is scanning time. Most of those who own handheld scanners like to take them along on vacation: to fairs, amusement parks, etc. Whenever there's a crowd, there's bound to be two-way radios in use. Those with scanners at arm's reach will know everything that's going on.

If you're planning on visiting a state or federal park, you may want to check regional scanner directories to see what frequencies are used by park rangers and crews. Rangers aren't the only ones to use radios in a park. You may also find maintenance crews, concessions, security units, lifeguards, front-gate personnel and parking lot attendants using radios during summer months.

Amusements and theme parks are also popular scanner hot spots. Check the 151, 154, and 461-465 MHz business band frequencies for frequencies used by security, ride operators, maintenance, hosts, parades, music shows and programs, admissions, and more. You're bound to hear reports of lost children (or is it the parents who get lost?), crime, undercover operations and other various activities associated with crowds of people on hot summer days.

You'll find business frequencies active at various other summer events, too, such as baseball games (stadium security is a primary user), auto races (hear the drivers talk to their pit crews), Special Olympics (464.500 and 464.550 are favored by these groups), fairs and festivals (support crews and security will use radios a lot) and more.

To find frequencies used at these various events, be sure to check the business band frequencies in the 151.625 to 151.955 MHz range, the 154.515 to 154.625 MHz range and the 460 to 465 MHz range. The frequencies of 151.625, 464.500, 464.550, 469.500 and 469.550 are reserved for itinerant users and you can almost always find folks using these frequencies for everything from surveying to bridge building to football teams and more. No matter where you live in the United States, you are bound to find someone using one of these frequencies at any given time during the year if you keep a constant watch on the channels. In addition, the frequencies of 154.570 and 154.600 MHz are reserved for low-power use (2 watts) and often are used for purposes such as security at stadiums and facilities like museums and more.

When searching through the 461-465 MHz band, be sure to search in 12.5 kHz steps so you don't miss all the potential activity on the low-power (2-watt) splinter frequencies offset by 12.5 kilohertz from normal full-power channels. The low-power channels

can be used for repeaters, phone calls, paging, walkie-talkies, data or telemetry, and any other conceivable use.

R. Vane of Rockville, Maryland, passes along some frequencies of interest for Washington, D.C. area. He says that 460.475 MHz is used by Metropolitan Police in the southeast section of the city, which is a high-crime area; 166.725 is used by national park police on the Washington Mall; the National Institutes of Health in Bethesda, MD., uses 411.450 for police; and bridge police on the Chesapeake Bay Bridge use 453.575.

Jean Fillion of St. Blandine, Quebec, wants to know whether it is possible to buy a scanner with an option similar to the Bearcat 250 that would search through a frequency range and log how many hits a signal is heard on a given frequency. The Bearcat 250 was an immensely popular scanner because of its ability to log hits on frequencies. By looking at the number of times a frequency was active during the day while you were at work (the BC250 could log up to 99 hits), you could determine what frequencies were the most active in your area. Thus, you could eliminate dud frequencies from your scanner and only listen to active channels. The feature also proved popular for those searching out active federal government frequencies.

Unfortunately, there are no scanners that still offer this feature. Sometimes you can come across used Bearcat 250's at swap meets and hamfests, but there's always the possibility that because the scanner may be more than a decade old that something may be wrong with the radio. The closest option available would be the search and store option on Radio Shack's Realistic PRO-2006 (and the former PRO-2004 and PRO-2005) scanner. The search and store option on the PRO-2006 searches a given frequency range and will store 10 active frequencies into a special 10-channel memory. By reviewing what frequencies are stored in the 10-channel memory, one could get an idea of some possible active channels, however, you don't get an idea of actual activity on the frequency like the "hits" feature on the Bearcat 250.

Another letter from Canada comes from Deborah Mahoney of Ottawa, Ontario. Deborah says she's been a CB'er for 10 years and has been into scanning for two years. She likes to listen to both police and ham frequencies. Here's a list of some of her favorites: 142.095, Ottawa Provincial Police Channel 1; 142.485, OPP Channel 2; 142.725, OPP Channel 3; 142.635, OPP Channel 4; 142.335, NEPEAN; 149.605, Ottawa Ambulance Co.; 118.800, Ottawa International Airport; 145.410, 146.610, 146.670,

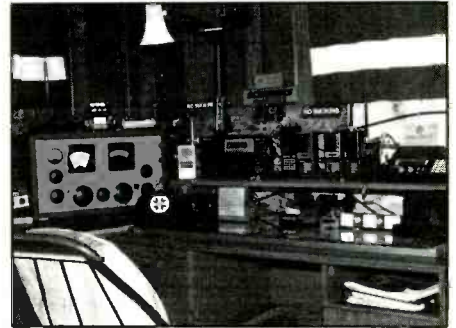

Ronald Tull, VY1RT, of Whitehorse, Yukon Territories, Canada, has a variety of equipment in his shack, including a barrage of handheld radios. Scanners include a 400 channel Realistic PRO-2004, and AOR AR3000 (not shown), a PRO-30, two PRO-36s and a PRO-32.

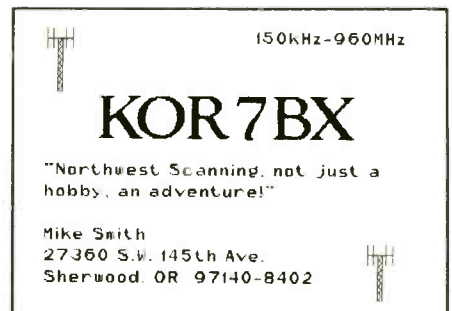

Station card of Mike, Registered Monitor, KOR7BX, of Sherwood, OR.

146.700, 146.805, 146.880, 146.940, 147.030, 147.150, 147.300, 443.300 and 443.800, all ham repeaters (the 147.150 and 443.300 repeaters are sponsored by the Mounted Police College); and 155.610, Cumberland Township Fire Department.

Rod Souza of Wailuku, Hawaii, says a few of his fellow scanning hobbyists on the island of Maui were wondering what frequencies the space shuttle uses when talking with Houston or Cape Canaveral, especially if they are over Hawaii. While most shuttle transmissions take place on microwave frequencies through satellites out of range of scanners, you can definitely hear the shuttle when it tests its UHF frequencies, usually right after launch and before landing again in California. Frequencies used by the shuttles include 296.8 MHz primary and 259.7 MHz secondary. While listening to these frequencies (which cannot be tuned in on all scanners), set the radio to the AM mode. In addition, 279.0 (again, AM



mode) has been used by astronauts to communicate among themselves while working outside the spacecraft.

The first trick to hearing the shuttle is patience, as an expert space communications listener constantly tells me. Tune your receiver to listen to only the shuttle's frequencies (if you're listening to police and fire calls at the same time, you're bound to miss the shuttle). If you can't maintain 24-hour watch on the frequencies, set up a tape recorder to catch the transmissions. Also, remember that the 200-MHz stuff is tested right after launch and right before landing. If the shuttle experiences some satellite communications troubles, they'll revert to the 200 MHz frequencies temporarily. That's when you might catch them on the air.

It also should be noted that during Defense Department flights, the shuttle may not use the 200 MHz frequencies at all because of the secure nature of the flight. In fact, the actual launch time is even considered classified information. However, during scientific flights, you will hear the crew loud and clear, if you are within range.

If you are a computer user, you may want to check out some of the satellite tracking programs available for downloading on some bulletin boards or available through advertisements in ham publications. By plugging in the Keplerian elements available through ham-related and NASA-related bulletin boards, you can let the computer track the shuttle's flight for you automatically. The program will tell you where the shuttle is at any given time and will offer other information helpful in trying to catch communications while in flight.

Wayne S. Burbage of San Diego, CA says he's been searching for frequencies used by the San Diego MTDB light rail vehicles for some time, and says his perseverance has paid off. The line, which runs from the Tijuana border of Mexico to El Cajon, uses these frequencies: 160.665, F1, main line-south; 160.380, F2 east line; 160.710, F3, maintenance; 160.905, F4, maintenance; 161.565, F5, maintenance; 160.935, F6, maintenance.

As a personal aside, you never know what you'll hear on the railroad channels in the 160 and 161 MHz ranges. I work right next to a rail yard and workers' walkie-talkies are abuzz with activity all day long, whether it's to right a derailed car on the tracks or to notify a crew that the tracks are blocked. In fact, one day I heard an engineer operating along a main line request police be notified because he saw a body alongside the tracks. It later turned out that the woman was murdered and left in a wooded area along the tracks. Like I said, you never know what you'll hear.

What are hearing on your scanner? We invite you to send in your questions, comments, frequency lists, tips and photos of listening posts and antenna farms to: Chuck Gysi, N2DUP, Scanning VHF/UHF, Popular Communications, 76 North Broadway, Hicksville, NY 11801. ■

## To Order Back Issues

Send \$3.50 Per Issue (Check, Money Order, Mastercard, VISA, And AMEX).

Send All Correspondence To:

**CQ Communications**  
76 North Broadway  
Hicksville, NY 11801  
Or Call  
516-681-2922  
FAX 516-681-2926

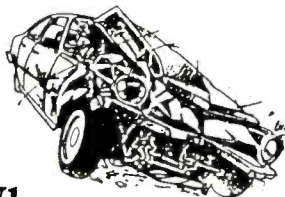

When  
seconds  
count,  
**REACT®** needs you...

...to summon help for an injured motorists, an elderly woman trapped in a fire, a trucker stranded in a blizzard, a drowning child!

As a REACT volunteer CB radio monitor you may be the only communications life-line for someone in serious trouble. You relay messages from those desperate for help to police or other emergency services.

Your REACT Team will also use CB and other radio services to provide safety communications for events like parades, marathons and even balloon races. The fellowship with other REACT members at Team meetings and annual conventions is an added bonus.

Volunteer. Join Today!

Add a New, Exciting  
Challenge to Your Life.  
Help Save Lives  
and Property!

**REACT International, Inc.**

Tel (316) 263-2100

FAX (316) 263-2118

P.O. Box 998, Wichita, KS 67201



### Skyhooks

In any communication station, the antenna system is perhaps the most important system of all. You may own a Sangean ATS-800 or a Sony CRF-V21, a Cobra 901 or an AR-3000, a Kenwood 1,000 or a NDR-535 and yet in large part your antenna and feedline will determine what and how well you hear the target station. This is especially true when dealing with satellite signals (as you TVRO people know all too well) or any VHF/UHF signal for that matter. Let's take a look at antennas for satellite operation and feedlines while we are at it.

The 10 meter satellite band is the easiest to deal with. It does not require much in the way of special attention. 10 meters is the home of the Soviet RS series satellites. Here you can use a dipole, an 11 Meter CB Beam, a vertical, a discone or a lowband scanner groundplane with good results. The discone happens to be my favorite because of its wide frequency coverage and ease of installation and its small size. Its horizontal elements are great for intercepting signals from overhead.

Most Amateur Satellites are spin stabilized. They rotate with a left hand spin or a right hand spin. This spin stabilizes the satellite's orbit and provides cooling for the satellite. Cooling is necessary because any object subjected to sunlight in the the vacuum of space is exposed to extreme heat, in the neighborhood of several hundred degrees. Spinning is the most economical way to cool a space craft.

This motion also produces what is called *spin modulation*. This can be identified by the slow deep fades or rapid flutter of the signal from the satellite. This is due to the constant polarity changes of the downlink signal. Most spacecraft in Amateur service use dipole or whip antennas. The faster the spin on the spacecraft, the faster and more troubling the effect on the signal.

There are other reasons for signals from space to fade, but the only effect we can improve is the change in polarization. Twist or circularly polarized antennas and good coax cable help. Remember, satellite communications, like most VHF/UHF DX'ing, involve weak signals and it takes quality receivers to recover them. It is not like listening to BBC World Service or HCJB or even a 1,000 watt utility station. Some people will only work with strong signals so they buy pre-amps, the best coax and twist antennas. This becomes more desirable the higher the frequency we go. I think most people bring their HF communications expectations to both satellite and 2 meter SSB operation and often go away un-



A two element twist for satellite work. Courtesy Ron Burke KB9DJA.

happy because they don't take the time to learn the system.

When buying coax a simple rule applies, by the best coax you can afford. Above 150 MHz you want a coax with less than 3 dB loss per 100 foot.

There are currently 4 packet satellites in orbit. Packet is the latest data mode in use on the Amateur bands. As on the 10 meter satellite band, simple antennas work well on receive. Dual band verticals are common, like the Cushcraft AR-270 or the Hustler G6-270, which operate on both 2M and 70 CM which happen to be the bands the Packet satellites use.

If you want a good, inexpensive antenna that you can build yourself, I have a suggestion. Try a single element twist. It is a two meter cross dipole using a 1/4 wavelength phase shift tuning stub. It can be made of ridged wire or aluminum. You can even make it out of small gauge wire (for listening only). Ron Burke, KB9DJA, (see the attached photo) built his inside PVC pipe. The antenna can be put in the attic or mounted outside if you build it from ridged material. Start by cutting a dipole for 145 MHz. It would be 36.3 inches long. Remembering your formula for half wavelength is  $468/145$  MHz. To figure the 1/4 wave phasing stub use  $234/145$ . The two dipoles are phased  $90^\circ$  apart.

When using the antennas for transmitting, you may find you need to do some trimming in the elements' lengths. Try to cut it for the specific frequencies you plan on using. With some experimentation you could make a dual band antenna of this configuration by adding elements for 435 MHz and a 1/4 wave phase loop. You simply attach the other elements

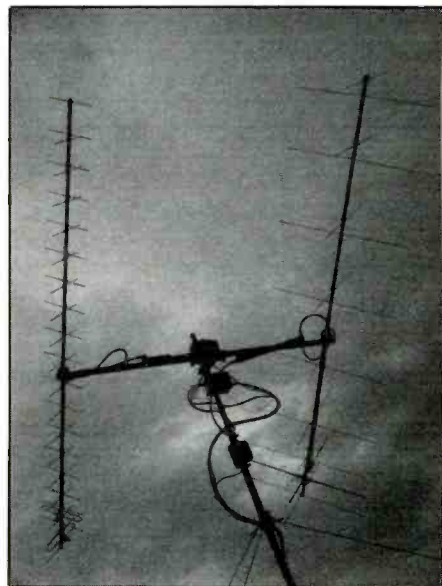

An example of a 145 and 435 MHz (RHCP) twist antenna. Courtesy Jean Marc Gigot F6IAL.



What kind of antenna is buried in this photo? First correct answer gets something for their wall from NASA.



First person with the closest count and correct ID of antennas will win a NASA photo. Take a guess!

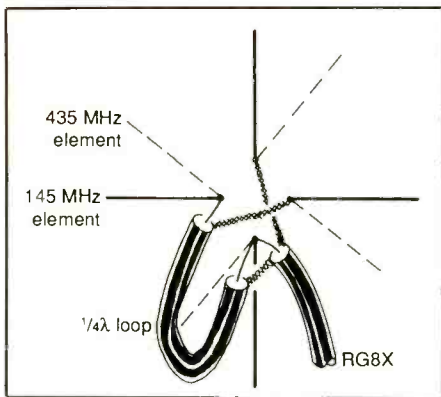

Figure 1- Omni-twist satellite antenna.

to the same corresponding points and you'll have an antenna like the one shown in figure 1. With some luck it should work like a curtain or fan dipole. I have not yet added a pair of 435 MHz dipoles to my twist yet but expect to have to do some fine tuning when I do. Either way it will work as a great receive antenna. It has great omni-directional characteristics for overhead satellite operation and works very well on packet satellites. The polarity of the antenna, from RHCP to LHCP, can be changed by altering or reversing the connection points on one of the dipoles. Reverse the ground shield and center the wire connections. Of course, you could always go

up to the attic and simply flip the antennas over, HI.

You will find the home-made dual band twist antenna or a discone will work well on the 137 MHz weather satellite band and the Fleetsat military satellites can be heard on either antenna. Because these satellites are over the equator and some 22,000 miles out, some gain would be appropriate here. It can be had by pointing a yagi or twist beam in the direction of the satellites or using a pre-amp. The government and military lease commercial satellites called Gapsats and use transponders on the Marisat. All use a geo-stationary orbit. These satellites use frequencies between 200 & 400 MHz. Most of the unencrypted voice traffic is found near 260-263 MHz.

This brings me to a letter I got recently from a Satellite Sleuth in New Orleans. Mark Burkart, KB5GVK, wants to know why the voice activity on Fleetsatcom 7 has just about dried up. Mark says his best luck on 7 has been on 249.125, 250.350, 262.300 and 263.825 MHz. He mentions that one of his favorite groups identified as Raymond 24 on the satellite seems to jump between the Fltsat and Marisat spacecraft. Well, Mark, there are probably several reasons for the decreased activity. 1. Things may simple be relatively quiet on the military front. 2. We are reducing the number of military bases and personnel nationwide and worldwide. 3. As this is done it opens up some of the secure satellite channels and secure landline links. Remem-

ber that over 80% of all military, diplomatic and intelligence traffic is routed through secure telephone lines or fiber optic lines. Whatever is left will go via satellite (secure) the rest go in the open. I should mention that when it comes to the military satellites Mark is loaded for bear! He uses a Yaesu FRG-9600 a 5 turn (element 262 MHz Helix and a 10dB pre-amp. Keep us posted on your monitoring, Mark.

Now we hear from Michael W. Csontos of Lima, New York. Micheal asks about Goddard Spaceflight Centers Radio Station WA3NAN. He happened onto a shuttle broadcast and could not write down all the frequencies in time. I hope you caught the April issue Michael, we gave you a lot more than the WA3NAN freqs: 3.860, 7.185, 14.295, 21.395, 28.650 and 147.450 MHz. Good to hear from you, Michael.

I also heard from the National Oceanic and Atmospheric Administration this week. Ms. Bethany E. Theilman was kind enough to inform us of a address change. In the March issue I gave you an address from which you could get a TIROS-N USER'S Guide. The New Address: National Oceanic and Atmospheric Administration, Data Collection and Direct Broadcast Branch, World Weather Bldg, Room 806, 5200 Auth Road, Camp Springs, MD 20746. Thank you Ms. Theilman, I appreciate the update, as I am sure do our readers.

Two final notes. Things are ever changing  
(Continued on page 74)

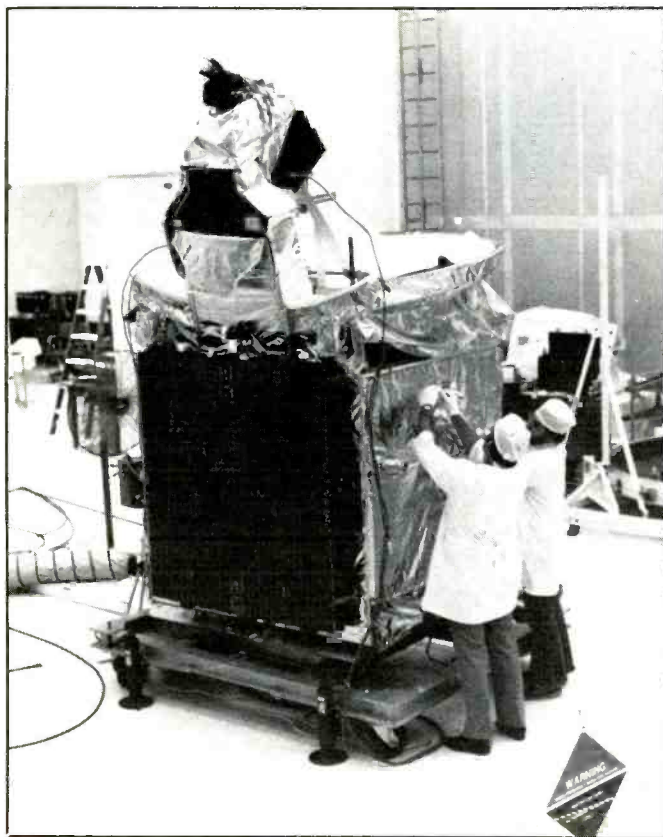

An RCA SatCom being readied for launch. (Photo courtesy NASA)

This is a Lesat, also known as a Syncom by the military. It is a leased satellite to supplement Fleetsatcom. (Photo courtesy NASA)

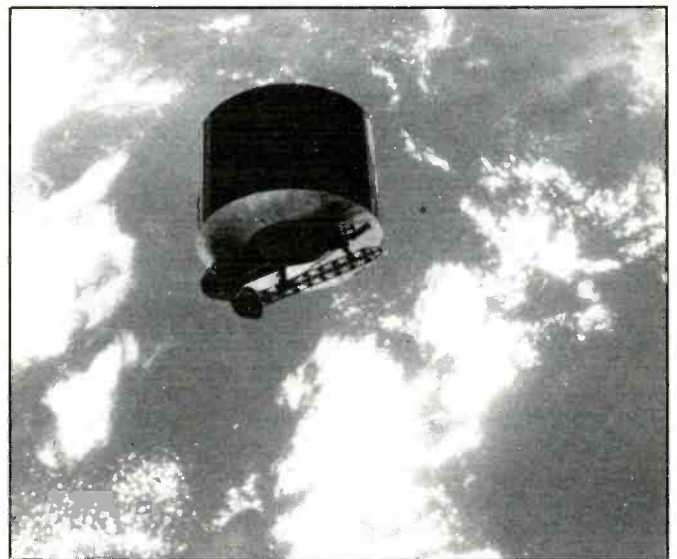

# TELEPHONES ENROUTE

BY TOM KNEITEL, K2AES

## WHAT'S HAPPENING WITH CELLULAR, MARINE & MOBILE PHONES

Cellular service suppliers have taken their share of hits, what with the economic conditions of past months. People have lost their jobs, companies have gone bankrupt, and the result is that lots of cellular bills may never get paid. But there's more.

Efforts to cheat, swindle, and defraud the cellular companies look to be on the upswing. Craig J. Moyer, KB7OIH, of Bountiful, Utah, sent in a clipping from Salt Lake City's *Deseret News*. A story by Jay Evensen and Wil Grey told of a typical example.

It seems that an auto body shop owner fired an employee, putting the former employee's cellular phone in a cabinet until someone else was hired for the job. Even though the phone had stayed in the cabinet, the body shop owner got a bill for \$150 worth of numerous calls charged to the phone.

The body shop owner came to learn that he had become a victim of "roamer fraud," so called because it is based on roaming agreements between different cellular service suppliers.

When a cellular phone is used beyond its normal service area ("roams"), it must be accommodated by various service suppliers. At such times, when a call is attempted, the call handling equipment tries to match up the permanent serial number ("ESN") of the calling cellular phone with the unit's assigned identification ("NAM"), or phone number. The call will be put through only if it's a good match.

Cellular hackers use specialized equipment that randomly attempts to match numbers to discover a working pair. When such a match is found, a storefront operation is opened to offer cellulators with pirated chips. A supply of chips is obtained and programmed to do the job. Communications technology calls for the use of chips in just about every circuit of a transceiver, so it's just a matter of finding which ones to pirate. This equipment is usually sold to those who exist on the fringes of society. Drug dealers like to use these services because their calls can't be easily traced back to them, especially since the call is being charged to a subscriber who may be hundreds or even thousands of miles away.

When the body shop owner complained about his bill to US WEST, the cellular service supplier, they checked out all of the called numbers on the bill. They all belonged to family members of the former employee's ex-wife.

The former employee denied any knowledge of the calls, but agreed to pay for them anyway. Nobody thought he really would inasmuch as he was originally fired for stealing from his employer.

The body shop owner has gotten a new



*Chips are used in virtually every circuit of modern transceivers. Chips programmed with deliberately misleading data have found a vexing and illegal place in the cellular phone realm, thanks to fly-by-night pirates. (Photo courtesy Texas Instruments.)*



*The New York City Housing Police equipped its Mobile Command Bus with cellular phones, thanks to donation of the equipment by NYNEX Mobile Communications. This allows processing suspected criminals at the scene of the crime. At the dedication of the bus were reps of the New York City Housing Police, New York City Housing Authority, New York City Transit Authority, and NYNEX Mobile Communications.*

number assigned to his cellular. He figures that his former employee is either a cellular hacker, or else has a friend who is one. The former employee already knew the unit's ESN and its NAM, so all he needed was a chip programmed with this information for use in another cellular phone. The body shop owner suggests all cellular owners check their bills carefully for roamer calls that were never made.

In another instance, according to what US WEST tells me, five Middle Eastern nationals

were arrested in Phoenix by the Secret Service for cellular fraud involving calls placed to Middle East countries.

The arrests resulted after the Secret Service raided two residences and found more than 35 cellular phones, 10,000 chips used for encoding legitimate cellular access numbers, plus other cellular equipment, and log-books of overseas calls.

Suspicions were originally stirred when lots of international calls started coming from cellular phones in Phoenix. This skewed the known calling pattern for Phoenix and triggered the investigation. Again, cellular telephone and microchip technology was being used to clone the phone and serial numbers of legitimate cellular users.

The equipment here was so sophisticated that it could intercept cellular calls and get an instant decoded read-out of ESN's and NAM's. Apparently, the suspects would drive around town with this device in their car, monitoring for short-range cellular mobile-unit signals on the mobile-only channels. Information obtained in that manner could then be transferred to chips used in the 35 confiscated phones.

This investigation was aided by NewVector, a nationwide task force organized by the cellular phone industry, and the work of the Guidry Group, a Houston-based high-tech investigative firm. Since September of last year, NewVector has been responsible for more than one hundred arrests and confiscation of hundreds of stolen cellulators, or phones with bootleg chips installed.

### Cellular Security Matter

With all of the flap over cellular privacy and voice security, who'd have thought that the fight to increase this privacy (which is one of the favorite time wasters of Congress) would cause consternation in other areas of the federal government?

Some new models of cellular phones to be marketed here and abroad will have built-in digital scrambling circuits to thwart casual eavesdropping. But how much privacy protection is *too much* privacy protection? That's what the National Security Agency wants to know. This "Big Brother" agency eavesdrops on phone calls in overseas nations, so they appear to be wondering if the new scrambled cellulators (at least, the ones sold overseas) will still be able to be monitored by their agency. Like, will the NSA be able to get the descrambling codes, or what?

NSA claims their only concern is whether new scrambling methods to be used will be compatible with the scrambled cellular phones that are already in use by some government agencies. You buy that?



This new Sony CM-H1 handheld is a real beauty!

### Cellular In The Hole

If you've driven around Boston and used your cellular, you know there are two famous dead spots. These are the Callahan and Sumner Tunnels, which are used between Boston and Logan Airport and the North Shore.

Weep no more. NYNEX installed specially designed devices to allow full cellular operation from the entire length of these mile-long holes in the ground.

NYNEX tells me that this system is designed around a slotted coaxial cable that extends the length of each tunnel. It's a mile-long antenna, but operating in the 800 MHz band. This system design is the first of its kind for cellular use in North America.

The one thing they haven't yet worked out is that only calls you ever get in these tunnels are from trolls.

### Dual Digital/Analog Cellular Unit Announced

Nokia Mobile Phones introduced the Nokia 6000, a transferable mobile phone that can



Panasonic's KX-T9000 is a 900 MHz cordless telephone with a built-in digital voice scrambler.

operate in the standard analog (AMPS) mode and also the new digital (TDMA) mode. The unit incorporates the CTIA I5-5A Revision B standard to provide voice privacy and authentication. The unit has all of the standard cellular phone features.

The basic configuration of the Nokia 6000, with transceiver, handset, and cradle has an MSRP of \$1,199. The transferable kit for car-to-car configurations has a bag adapter, cigarette lighter adapter, a hands-free microphone, carry bag and clip-on antenna. Accessories include a voice recognition unit, data/FAX adapter, and two external hands-free speakers.

It should be available by the time you read this. For more information, contact Nokia Mobile Phones, Inc., 2300 Tall Pines Drive, Largo, FL 34649.

### New 900 MHz Cordless Phone

Panasonic has brought out the KX-T9000 cordless phone operating in the 900 MHz band, which the company claims offers "significantly better reception, greater range, and better security." We assume this means in comparison to the 46/49 MHz band cordless phones, although this isn't specifically stated.

The phone will scan through its 30 available channels until it finds the one with the least amount of interference for use. The range is only described as "almost twice that of most cordless phones," so we would guess this to mean around 3,000 ft. to 3,400 ft.

As for security, the "900 MHz frequency bandwidth" is represented as offering "greater security than conventional cordless phones." Probably what this double-talk intends to imply is that there are more potential eavesdroppers on 46 MHz than on 900 MHz. More im-

portantly, the KX-T9000 has a built-in digital security system with up to 1-million possible automatic security codes.

The early data they sent me on the unit was one step beyond being no information at all, however this does look like it's an emerging technology. Panasonic's stuff is good, so this is undoubtedly a worthwhile device. The MSRP is \$499.95. Check with dealers who sell Panasonic products. By now they may have more than the skimpy preliminary info that Panasonic provided me.

### Sony, So Neat!

Sony brought out its first handheld cellular. Weighing in at 11 oz. (with battery), the CM-H1 has a noise canceling mike, and that makes it ideal for use aboard your boat, or at job sites, or other locations where the background noise level is high.

The battery offers more than an hour and a half of talk-time, or 20 hours of standby operation. Plenty of nifty features in the small unit, too. Some are a 99-number alphanumeric directory, last number redial, access tones for devices using DTMF signaling (such as answering machines, voice mail, etc.), VOX, security locks, call timer, volume control, and more.

A wide range of accessories are available for the hopeless gadgeteer who will not only want this cheeky little unit, but all of the trinkets and extras that you can get with it. We fell in love with this thing at first sight. The MSRP of the basic unit is \$999.00. It is being offered by cellular and autosound dealers.

It's put out by Sony Corporation of America, Sony Drive, Park Ridge, NJ 07656.

We always welcome input from readers, manufacturers, and service suppliers—cellular, maritime, IMTS, and beepers. ■

## Uncle Harry Explains It All For You

**Y**es, I've gotten more letters since my last "mailbag" column, and once again I'm going to answer some of the more interesting (or strange) ones here. Let's get rolling.

*Which is better—the XXXXX antenna tuner or the ZZZZZ antenna tuner?*

Again, I haven't tried every item of SWL gear available, so I can't comment on items I haven't used. I find it hard to believe there is much difference between one passive (that is, unamplified) antenna tuner and another. Sure, some models are bigger and more expensive than others, but those models are designed to tune transmitting antennas and handle hundreds of watts of power. For SWL'ing, a simple random wire tuner will do fine.

*I keep hearing this really strong signal from about 450 to 460 kHz. There's never any modulation, except for a "squeal" at times, and the signal's on whenever I check. What station is this?*

Guess what? It's not a station you're hearing, it's your receiver's 455 kHz intermediate frequency amplifier signal that's "leaking" through. A lot of less expensive receivers have design shortcomings like this. If you're wondering if your receiver is producing a weird signal, disconnect all antennas or fully collapse any telescoping ship antennas. If the signal's still there, it's your receiver that's the culprit.

*How can top DX'ers spot weak signals right at the noise level?*

Spotting a faint signal or carrier in the AM mode is often difficult. Try this—put your receiver in either the USB or LSB mode when looking for faint signals. The carrier from any faint signal will "beat" against the replacement carrier your receiver produces in the USB or LSB mode and produce a heterodyne (or "whistle"). That heterodyne will be your clue that something interesting is happening on a frequency. When top DX'ers find such a weak carrier, they reach into their bag of tricks (preamplifiers, synchronous detection, exalted carrier reception, etc.) and try to bring the signal up to readability. Even if they can't immediately produce readable audio, they stay put on the frequency for a few minutes in case the signal manages to fade up.

*Hey, that's a neat trick! Got any others???*

Okay, thunderstorm season is now in full swing and those static crashes can really make night reception on frequencies below 5 MHz a pain. One way to minimize the effects of lightning static is to reduce your receiver's RF gain control somewhat. The exact amount varies depending on the situation, but the lower receiver gain can make a big difference

MEL UDARA  
AIR MAIL

URUSAN KERAJAAN

Date: 22.12.1987

Radio Television Malaysia Sarawak takes great pleasure in confirming your reception of our Kuching station on Frequency: 61 m - 4950 kHz Time: 15.28 - 15.56 GMT Date: 4th. December, 1987

To: MR. HARRY L. HELMS, San Diego, California, U.S.A.

BROADCASTING HOUSE

PRINTED BY SEE HUA DAILY NEWS

in how badly the static interferes with the signal you want to hear. The desired signal is weaker, but so is the static, and the net result can be more usable signal and less snap, crackle, and boom.

*Why won't stations answer my reception reports?*

There are a lot of possible reasons. Some of them you can do something about, while others are beyond your control.

A lot of reception reports forget to include essential things like the time, date, and frequency you heard the station. Other reports are really vague on details, often so much so that the station can't be sure if you really heard them. The fact that you can't understand the language used by the station isn't any excuse for skimpy details. Suppose the broadcast is in Spanish, and you don't understand Spanish. You could simply tell the station "Announcement in Spanish by a man" or "30 second long announcement in Spanish by deep-voiced man." Which one do you think is more likely to convince a station that you really heard them?

There are lots of other things you can do to increase the number of QSL's you get, especially from smaller broadcasters not beaming programs to North America. Try giving the time both in UTC/GMT and the local time of the broadcaster. An even bigger help is to write your reception report in the main language used by the country where the station is at. Remember to include return postage either in the form of mint stamps or one U.S. dollar. Finally, your report has to reach the correct address. *Passport to World Band Radio* added a list of shortwave station addresses to its latest addition, and this is probably the most accurate such list around.

Don't forget a little courtesy and good will in your report. You're asking a complete stranger to do a favor for you, and making

demands and ultimatums will get you nowhere. Politely ask for a QSL if your report is correct, tell them a bit about yourself and your interest in their country and culture, and throw in a picture postcard or other souvenir from your area.

Unfortunately, you're not going to get a 100% reply rate to your reports even if you do everything right. A certain percentage of your reports will get lost or stolen in the mail (in some parts of the world, letters from developed countries like the USA, Canada, and Britain are assumed to contain money). At many stations they may not have the item or staff to answer your report. The only way to deal with this situations is *persistence*. Some of my very best QSL's have been the result of follow-up reports. If you haven't gotten a reply after six months, try to hear the station again and send them a new report. If you can longer hear them, send a copy of your original report. Mention in your follow-up report that you've sent them a previous report, but that since you haven't heard from them you assume the original one was lost in the main. And keep trying—some top DX'ers have sent over a dozen reports before getting a desired QSL!

The big news is that numbers stations continue to be heard despite the collapse of the USSR! Even German language stations are still around, even though their supposed sources—East Germany and the Soviet Union—aren't. Maybe a lot (most of?) these stations were (are) coming from "our" side??? Check 6840 kHz during the evenings. It's still the hottest frequency around for various numbers stations, and if you check at various times for a few evenings you're bound to hear unusual signals there.

7415 kHz is a popular frequency with pirate radio operators. Recently, that frequency has become sort of an "intercom channel" for

pirate operators to use after or in between broadcasts. While most pirate activity is AM, these "intercom" transmissions are in USB. (I've heard a couple of pirate broadcasters who use AM for their broadcasts show up here afterwards on USB.) These transmissions are mainly gossip and chatter ("is Radio Anarchy planning to be on next weekend?") relating to pirates and pirating. Check here late on Friday and Saturday nights as well as nights on various holidays such as the Fourth of July and the Labor Day weekend.

If you're interested in pirate broadcasters, numbers stations, or covert communications, then you need to belong to the Association of Clandestine Radio Enthusiasts (ACE). ACE is the only club around that is devoted exclusively to the "twilight zone" of radio, and is really the only way to keep up with the fast moving world of pirate radio. They publish a monthly bulletin, the ACE, and I write a monthly column on the latest covert station loggings for the ACE. Several pirate operators are apparently ACE members (one member of the ACE editorial staff was actually busted by the FCC last October for pirate broadcasting!). The FCC also reads the ACE—a couple of FCC personnel have commented to me about things I have written in my ACE column! Membership is currently \$18 in the U.S. and \$19 in Canada; a sample copy of the bulletin is \$2 from the Association of Clandestine Radio Enthusiasts, P.O. Box 11201, Shawnee Mission, KS 66207-0201.

**1-800-666-0908**

**New Equipment Orders & Prices Only, Please**

**Shortwave Radios**

SONY® • All Popular Models Including The ICF2010, SW55, And The New SW77  
 • Phillips DC777 AM/FM/CASS/Shortwave Car Radio • Sangean • ICOM • JRC  
 • Panasonic • Yaesu • And the Superb Drake R8

Grundig Satellit 500  
 On Sale! Call For Low, Low Price.

**Scanning Radios**

Featuring AOR Models AR1000XLT and AR3000A • ICOM R1, R100, and R7100 • Uniden Bearcat - All Models

**Amateur Radio Equipment**

Factory Authorized Dealer For:

**ALINCO** **STANDARD**  
**KENWOOD** **COMET**  
**YAESU** **Cushcraft**  
**DIAMOND** **MJF** **ICOM**  
 ANTENNA Accessories, etc.

• Call For Our Low Discount Prices •  
 For info and tech help call (203) 666-6227  
 Out-of-State Sales Call 1-800-666-0908  
 Conn. Sales Call (203) 667-9479

**LENTINI COMMUNICATIONS, INC.**

21 Garfield St. Newington, CT. 06111

C.O.D.'s OK SAME DAY SHIPPING

CIRCLE 46 ON READER SERVICE CARD

**10 HOUR RECORDER**



- excellent audio quality
- trouble-free metal (NOT plastic) chassis
- 5 hours per side, C120 tape
- volume AND tone controls
- AC/DC operation
- digital counter
- BUILT-IN voice activation (no external box) - add \$19\*

**\$107\***

**AUTOMATIC TELEPHONE ADAPTER**

- starts/stops recorder automatically
- FCC approved

**\$16\***



\*special prices for PopComm readers

NO shipping charges on prepaid orders. COD's OK. California residents add tax.

40 Page Catalog \$2 (Refundable)



**VIKING INTERNATIONAL**

SINCE 1971  
 150 EXECUTIVE PARK BLVD. #4600  
 SAN FRANCISCO, CA 94134  
 PHONE: (415) 468-2066  
 FAX: (415) 468-2067

CIRCLE 26 ON READER SERVICE CARD

# THE FUTURE OF AMATEUR COMMUNICATIONS

Once in a lifetime, a transceiver is introduced that's so extraordinary and innovative that it opens a totally new era in HF communications. ICOM's pacesetter IC-781 proudly exhibits that hallmark achievement with futuristic designs and features of true legendary proportions. Whether DX'ing, contesting, pioneering new interests or enjoying unquestionable top-of-the-line performance, the IC-781 is indeed today's standard of excellence!



**Multi-Function Five Inch CRT.** Displays frequencies, modes, memory contents, operating notes, RTT, two menu screens, plus a panoramic view of all signals in a selected range. A portion of the screen also serves as a display for data modes like RTTY, AMTOR, and PACKET.

**Dual Width Noise Blanker** includes MCF filter plus level and width controls to eliminate pulse and woodpecker noise with minimum adjacent-signal interference.

**Unique Spectrum Scope.** Continuously indicates all signal activities and DX pileups with your operating frequency in the center. Selectable horizontal frequency spans of 50, 100, and 200KHz for each side of the frequency you're listening to. Vertical range indicates relative signal strengths. A contesteer's dream!

**Incomparable Filter Flexibility.** Independent selection of wide and narrow SSB filters plus CW filters. Second and third CW IF filters are independently selectable!

**Dual Watch.** Simultaneously receives two frequencies in the same band! Balance control adjusts VFO A/B receive strength levels. You can check additional band activity, even tune in your next contact, while in QSO without missing a single word!

**DX Rated!** 150 watts of exceptionally clean RF output. Easily drives big amplifiers to maximum power.

**Twin Passband Tuning** with separate controls for second and third IF stages! Increases selectivity and narrows bandwidth, independently varies low and high frequency response, or functions as IF shift.

**A Total Communications System!** Includes built-in 100% duty AC supply, high speed automatic antenna tuner, iambic keyer, semi-automatic or full QSK CW break-in to 60 wpm, Audio Peaking Filter (APF), RF speech processor, multiscanning, 105dB dynamic range, all-band/all-mode receiver with general coverage, and much more!

**ICOM Dependability.** The phenomenal IC-781 is built for action and backed with the most extensive warranty in the industry.

See the IC-781 at your local ICOM dealer.

**ICOM**  
 First in Communications

ICOM America, Inc., 2380 116th Avenue N.E., Bellevue, WA 98004  
 Customer Service Hotline (206) 454-7619  
 3150 Premier Drive, Suite 126, Irving, TX 75063  
 1777 Phoenix Parkway, Suite 201, Atlanta, GA 30349  
 ICOM CANADA, A Division of ICOM America, Inc.,  
 3071 - #5 Road, Unit 9, Richmond, B.C. V6X 2T4  
 All stated specifications subject to change without notice or obligation.  
 All ICOM radios significantly exceed FCC regulations limiting spurious emissions. 781188.

# POP'COMM'S World Band Tuning Tips

July - 1992

Freq.	Station/Country	UTC	Notes	Freq.	Station/Country	UTC	Notes
2310	VL8A, Alice Springs, Australia	1000		6010	R. Mil, Mexico	1200	SS
2415	Wenzhou PBS, China	1200	CC	6015	R. Austria Int'l	0530	via Canada
3200	Trans World Radio, Switzerland	0300		6020	R. Netherlands	0030	
3205	R. West Sepik, P. New Guinea	1230		6040	Deutsche Welle, Germany	0130	via Antigua
3200	HCJB, Ecuador	0500	SS	6050	Caracol, Colombia	0100	SS
3235	R. Clube Marila, Brazil	0200	PP	6050	R. Nigeria, Ibadan	2230	
3240	Trans World Radio, Swaziland	0345	close	6055	Spanish National Radio, Spain	0430	SS
3250	R. Luz y Vida, Honduras	0230	SS	6060	R. Australia	1500	
3255	BBC, Lesotho	0300		6100	INBS, Iceland	0715	Icelandic
3270	Ecos del Oriente, Ecuador	1030	SS	6105	Su Pantera, Mexico	1130	SS
3285	La Voz del Rio Tarqui, Ecuador	1000	SS	6116	La Voz del Llano, Colombia	1000	SS
3290	R. Centro, Ecuador	0900	SS	6120	R. Globo, Brazil	0900	PP
3300	R. Cultural, Guatemala	0200	SS	6130	R. Portugal	0700	sign off
3315	SLBS, Sierra Leone	0600		6135	R. Santa Cruz, Bolivia	1000	SS
3320	R. Orion, South Africa	0245		6135	Swiss Radio Int'l	0230	
3365	R. Rebelde, Cuba	0300	SS	6140	Australian Bc. Comm.	1100	
3377	R. Nacional, Angola	0430	PP	6160	CKZU, Canada	1300	
3381	Malawi Broadcasting Corp.	0330		6185	R. Educacion, Mexico	0130	SS
3395	R. Catolica, Ecuador	1030	SS	6190	Sender Freis Berlin, Germany	0430	GG
3905	R. New Ireland, P. New Guinea	1100	SS	6210	Croatian Radio	0000	Croatian/EE
3955	BBC	0530		6245	Vatican Radio	0430	
3995	Deutsche Welle, Germany	0330	GG	6299	Sani Radio, Honduras	0400	SS
4212	R. Tucuban, Ecuador	1100	SS	6515	Tadzhik Radio, Tajikistan	0100	
4473	R. Movima, Bolivia	0000	SS	6576	R. Pyongyang, N. Korea	1100	
4605	R. Baghdada, Iraq	0225	sign on, AA	6670	R. Santa Monica, Peru	1100	sign on, SS
4735	Xinjiang PBS, Tibet, China	1200	CC	6900	V of Meterology, Turkey	0530	TT
4740	Radio Moscow (ex-R. Afghan relay)	0300		6910	R. Russia (feeder)	0230	RR
4770	R. Nigeria, Kaduna	0430	sign on	7125	IRRS, Italy	0500	
4783	RTV Malienne, Mali	0530	FF	7165	R. Free Europe	0600	Romanian
4800	La "N," Dominican Republic	0500		7185	Voice of Turkey	2300	sign on
4810	R. San Martin, Peru	0930	SS	7185	RTM, Mali	2130	FF
4815	RTV Burkina, Burkina Faso	0600	FF	7190	Rep of Yemen Radio, Aden	0300	sign on, AA
4815	Rdf. Londrina, Brazil	0130	PP	7200	Somali Bc. Service, Somalia	0259	sign on
4850	CRTV, Cameroon	0430	FF/EE	7203	R. Lubumbashi, Zaire	0430	FF
4855	R. Centenario, Bolivia	0000	SS	7215	Voice of the UAE	2300	
4865	La Voz del Cinaruco, Colombia	0300	SS	7220	All Union Radic, Russia	0100	RR
4865	Gansu PBS, China	1130	CC	7235	Deutsche Welle, Germany	0400	AA, via Malta
4870	ORTB, Benin	0457	sign on, FF	7240	Croatian Radio, Croatia	0300	
4875	Super Radio, Brazil	0235	PP	7255	V of Nigeria	0500	
4885	Ondas del Meta, Colombia	1000	SS	7265	Voice of America, Botswana relay	0258	s/on
4890	ORTS, Senegal	2345	FF	7305	Vatican Radio	0250	
4895	LV del Rio Arauco, Colombia	0430	SS	7315	Croatian Radio	0000	via WHRI
4900	R. Centinela del Sur, Ecuador	1100	SS	7315	R. Free Croatia	0330	via WHRI
4904.5	R. National, Chad	0427	sign on, FF	7345	R. Prague Int'l, Czechoslovakia	0100	
4910	Radio One, Zambia	0300		7375	R. For Peace Int'l, Costa Rica	0200	USB
4920	R. Tropical, Peru	1000	SS	7390	Deutsche Welle	1200	via USSR
4939	R. Continental, Venezuela	1000	SS	7400	R. Yerevan, Armenia	0338	
4950	R. Nacional, Angola	0400	PP	7400	R. Belarus, Belarus	0030	Byelorussian
4965	R. Santa Fe, Colombia	0400	SS	7445	Voice of Asia, Taiwan	1100	
4976	Radio Uganda	0400		7475	RTV Tunisienne, Tunisia	0400	AA
4990	Hunan PBS, China	1230	CC	7500	R. Baghdad, Iraq	0400	AA
5011	Escuelas R/fonicas, Ecuador	0225	sign off, SS	8000	JJY, Japan	1100	JJ, time stn
5015	R. Pioneira, Brazil	0230	PP	9022	VOIRI, Iran	0030	EE
5020	SIBC, Solomon Islands	0800		9265	Icelandic Ntl Bc Svc	0730	EE
5025	ORTB, Benin	0600	FF	9280	Voice of Asia, Taiwan	1000	CC
5030	R. Catolica, Ecuador	0200	SS	9325	R. Pyongyang, N. Korea	1300	
5035	R. Aparecida, Brazil	0030	PP	9395	V of Greece	1900	GG
5035	RTVC, Central African Rep.	0428	sign on, FF	9420	R. Europe Int'l, Italy	1000	II
5040	R. Ala, Russia	0330	s/on	9445	Voice of Turkey	2300	TT
5040	La Voz del Upano, Ecuador	0445	SS	9455	WCSN, Maine	0200	
5066	R. Candip, Zaire	0430	FF	9475	R. Cairo, Egypt	0200	
5260	R. Alma Ata, Kazakhstan	2230	RR	9480	TWR, Monaco	0645	
5275	WYFR, Florida	1500	via Taiwan	9486	R. Tacna, Peru	0400	SS
5560	R. Miskut, Nicaragua	0200	SS	9505	R. Yugoslavia	2230	to Europe
5935	R. Prague Int'l, Czechoslovakia	0100		9520	R. Veritas Asia, Philippines	1200	
5935	R. Riga, Latvia	0400	sign on	9530	Spanish National Radio	0500	
5950	GBC, Guyana	0900		9535	Trans World Radio, Bonaire	0300	
5905	R. Kiev, Ukraine	0300	EE	9540	R. Nacional, Venezuela	1100	SS
5995	R. Melodia, Peru	1000	SS	9545	R. Tirana, Albania	0530	sign on
6005	CKFX, Canada (relay CICO)	0600		9555	R. Portugal	0230	
6006	R. Reloj, Costa Rica	0700	SS	9560	R. Finland Int'l	0230	
6010	R. Mil, Mexico	0300	SS	9565	R. Universo, Brazil	0500	PP
6010	R. Mil Cuarenta, Venezuela	0830	SS	9570	R. Romania Int'l	0300	SS



Freq.	Station/Country	UTC	Notes	Freq.	Station/Country	UTC	Notes
9570	R. Korea, S. Korea	1400		11960	RTV Malienne, Mali	0900	FF
9575	R. Medi Un, Morocco	0030	AA	12000	R. Australia	1400	
9580	R. Tirana, Albania	0230		12015	R. France Int'l, via Gabon	1600	
9580	Africa No. One, Gabon	1900	FF	12055	Deutsche Welle, via tx in ex-USSR	0156	s/on
9590	FEBA, Philippines	0130	QRM'd	12095	BBC, England	2100	
9600	HCJB, Ecuador	0300	RR	12085	R. Damascus, Syria	2110	
9605	Vatican Radio	0300		12160	WWCR, Tennessee	2300	
9610	R. Norway Int'l	0200		13605	Capital Radio, via Voice of UAE	2230	
9625	CBC No. Quebec Service, Canada	2100		13605	R. Australia	1600	
9635	R. Portugal	2200	PP	13630	R. For Peace Int'l Costa Rica	0200	
9635	R. Afghanistan	1230		13635	Swiss Radio Int'l	2130	
9645	R. Norway Int'l	0300		13650	R. Pyongyang, N. Korea	0000	
9655	TWR, Swaziland	0256	sign on	13655	BRT, Belgium	2330	
9660	BBC relay, Cyprus	1445		13670	R. Canada Int'l	0245	
9665	R. Marumby, Brazil	2300	PP	13675	UAE Radio, Dubai	2000	AA
9690	R. Beijing, China	0330	via Spain	13685	Swiss R. Int'l	0700	
9695	R. Sweden	0330		13700	Radio Havana Cuba	0200	
9700	R. Sofia, Bulgaria	2000	GG	13855	INBS, Iceland	2300	Icelandic
9700	R. New Zealand	1100		14917.8	R. Kiribati	0600	
9710	R. Centras, Lithuania	0600	{last Sat/mo}	15020	All India Radio	1300	
9720	VOIRI, Iran	0030	EE	15060	BSKSA, Saudi Arabia	0400	AA
9725	Adventist World R., Costa Rica	1250		15084	VOIRI, Iran	0430	Farsi
9735	R. Oman	1945	AA	15090	R. Damascus, Syria	2115	
9735	Cyprus Bc. Corp	2230	wkdns, Greek	15100	Kol Israel	2130	EE
9745	R. Cairo, Egypt	0200		15110	Spanish National Radio	2000	SS
9746	R. Bahrain	2000	AA QRM-HCJB	15115	R. Austria Int'l	2145	
9750	R. Korea, S. Korea	1245	EE	15140	R. Nac. del Ecuador	1630	SS, via HCJB
9760	R. Tirana, Albania	0330		15170	R. Beijing, via Mali	1600	
9765	V of Mediterranean, Malta	0600		15180	R. Vilnius, Lithuania	2300	
9765	VOIRI, Iran	0100	EE	15185	R. Finland Int'l	2300	
9770	R. Beijing, China	0000	via Mali	15195	R. Japan	0500	
9815	KNLS, Alaska	0900	RR	15200	R. Bangladesh	1230	EE
9830	Croatian Radio	0600		15205	V of Palestine via R. Algiers	1700	AA
9840	Voice of Vietnam	1500		15208	R. Bangladesh	1230	
9875	Spanish National Radio	1900		15215	V du Sahara Libre (clandestine)	2200	via R. Algiers
9885	BSKSA, Saudia Arabia	2200	AA	15235	V of Great Arab Homeland, Libya	2000	AA
9905	BRT, Belgium	2100		15260	VOIRI, Iran	0230	sign on
9910	All India Radio	0115	s/off	15260	BBC, Ascension Island relay	0300	
9942	La Voz del CID (clandestine)	1330	SS	15320	UAE Radio, Dubai	2300	
9950	All India Radio	2200		15325	R. Japan	1500	via Fr. Guiana
9985	WCSN, Maine	2355	sign off	15325	Spanish National Radio	2230	SS
10000	R. Jordan	2000	AA	15345	RAE, Argentina	2200	SS
10260	CPBS, China	2100	CC	15345	Trans World Radio, Bonaire	1230	
11455	R. Kisangani, Zaire	0400	s/on, FF	15345	RTM, Morocco	1400	Eerber
11470	Iran's Flag of Freedom (clandestine)	0329	s/on	15350	R. Luxembourg	1900	EE
11530	V of Hope, Lebanon	1400		15365	R. RSA, S. Africa	0300	sign on
11550	RTT Tunisia	1800	AA	15425	R. Portugal	1500	
11595	RS Makedonias, Greece	1400	Greek	15430	R. Australia Int'l	1330	
11620	All India Radio	2000		15400	Radio Finland Int'l	1500	
11620	Vatican Radio	0145		15445	VOA relay, Botswana	2100	
11655	R. Netherlands	1930	FF	15470	R. Tashkent, Uzbekistan	1330	
11685	BSKSA, Saudia Arabia	2200	AA	15485	R. Vilnius, Lithuania	2300	
11695	BRT, Belgium	0600	Dutch	15505	R. Kuwait	2245	AA
11700	IBRA Radio, Portugal	1800	sign on	15525	R. Kiev, Ukraine	0000	
11710	RAE, Argentina	0100		15530	R. France Int'l, via Hungary	0630	FF
11715	R. Beijing, China	0330	via Mali	15550	Central People's Bc Stn, China	0230	CC
11720	R. Sofia, Bulgaria	0300		15575	R. Korea, N. Korea	0245	
11725	VOA relay, Botswana	0200		15650	Voice of Greece	1200	Greek
11734	R. Tanzania, Zanzibar	1730		15670	Brit. Forces Bcsting, via Cyprus	1400	USB
11735	R. Japan, via Gabon	2300		15750	R. Russia	1800	RR
11740	R. Baghdad, Iraq	1700	AA	17525	Voice of Greece	1515	
11755	R. Baghada, Iraq	1930	AA	17595	RTVM Morocco	1630	
11760	R. Vedo, Russia	1600	RR	17605	R. Vilnius, Lithuania	0000	
11780	R. Nacional Amazonia, Brazil	2030	PP	17665	R. Kiev, Ukraine	0000	
11790	R. Kiev, Ukraine	0000		17690	R. Minsk, Belarus	0030	
11790	R. Vilnius, Lithuania	2300		17710	R. Norway Int'l	1200	NN/EE
11795	UAE Radio	1600		17730	Swiss Radio Int'l, via Brazil	0200	
11795	Cyprus Bc. Corp.	2213	s/on weekends	17740	R. Yugoslavia	1200	
11805	R. Globo, Brazil	2300	PP	17740	R. Sweden	1300	
11810	R. Korea, S. Korea	0600		17740	R. Jamahiriya, Libya	2200	AA
11810	R. Jordan	1400	AA	17745	RTV Algerienne, Algeria	2000	AA
11822.5	R. Nacional, Colombia			17770	R. New Zealand Int'l	0445	
11830	R. Baghdad, Iraq	2300	EE/NA	17810	R. Japan	2330	
11830	R. Anhanguera, Brazil	2200	PP	17850	Radio France Int'l	1600	
11840	R. Japan	0130	via Sri Lanka	17860	Qatar Bc Service	1300	AA
11855	R. Beijing, China	1300		17870	R. Sweden	1530	
11870	Adventist World Radio, Costa Rica	2330		17870	VOA Botswana relay	0400	
11870	R. Denmark	1530	via Norway	17890	Spanish National Radio	1200	
11880	R. RSA, So. Africa	1615		21460	R. Moscow, Russia	1330	
11885	R. Yugoslavia	9023		21500	R. Sweden	1530	
11895	VOA Botswana relay	2300	sign on	21510	V of UAE, Un. Arab Emirates	0630	AA
11920	R. RSA, South Africa	0300	sign on	21515	Radio Portugal	1630	
11940	R. Romania Int'l	0200		21580	R. Pilipinas, Philippines	0230	
11940	VOA Botswana relay	0300		21690	R. Moscow	0800	RR
11950	R. Havana Cuba	0000		21705	R. Denmark, via Norway	1255	s/on, DD
11955	Voice of Turkey	0400	TT	25730	R. Denmark, via Norway	1255	s/on, DD
11960	R. Sweden	1130					



2 0433 SVA GR  
220800 SVA GR  
COMPUTER MESSAGE PLS DON'T INTERRUPT  
21 ATHINAI RADIO  
220433 SVA GR  
PRESS

CQ CQ CQ DE SVA SVA ; PRESS;  
Y E M

DELTIO ENIMEROSIS HAFTILLOHENON APO  
AKROASI RADIOFONIKON EKPOPON ERT KAI  
EPISKOPISI IMERISIOU ATHINAIKOU TYPOU  
PEMPTI 6.2.92

DYSARESKEIA TIS E EFRASE ELLINIKI KYVERNISI MESO YPOURGOU DIKAIOSYNIS  
PROS ALVANO OMOLOGO TOU GIA APOKLEISMO APO ALVANIKES EKLOGES TOU  
KOMMATOS TIS ELLINIKIS MEIONOTITAS OMONOIA. POLYDORAS TONISE OTI  
EKTOS DIAVIMATOS DIAMARTYRIAS POU EGINE PROS ALVANIKI KYVERNISI KAI  
YPOMNIMATA POU YPOVLITHIKAN PROS DASE KAI SYMVOULIO EVROPIS CHORA MAS  
ANAPTYSSAI DIPLOMATIKI DRASTIRIOTITA OLA EPIPEDA GIA NA KATANGEILEI  
APOKLEISMO OMONOIAS APO EKLOGES STOP

23 VOULEFTES ND ME EPISTOLI TOUS PROS PROEDRO VOULIS ZITOUN APO  
ELLINIKI ANTIPROSOPEIA KATADIKASEI PROSFATI AP FASI ALVANIKIS VOULIS  
POU PA AVIAZEI KATAFORA POLITIKA DIKAIOMATA ELLINIKIS MEIONOTITAS  
STOP

ME PS FISMA TOUS EVROPAIKO KOI OVOULIO EVROVOULEFTES PASOK ZITOUN APO  
YPEX TON 12 PAREMVOUN APOFASISTIKA PROS ALVANIKI KYVERN SI OSTE  
SCHEDIAZOMENO NEO EKLOGIKO NOMO DIASFALIZETAI ELEFTHERI SYGKROTIS  
KAI

LEITOURGIA KOMMATON CHORIS DIAKRIS I SE VAROS ME ONOTITON STOP  
SYMPOLOI EGINE CHTES SYNORA SE CHORIO MAVROPOULO IOANNINON METAXY  
IOHEL US SYMMORIAS ENOPLON ALVONON KAI ELLINIKIS PERIPOLOU. KATA  
ANTALLAGI PYROVOLISION SKOTOTHIKE ENAS ALVANOS STOP

PROSTI A APO 5000 EOS 200000 PROVLEPONTAI APO NEO KOK OPOIOS  
KATATETHEI VOULI FEVROUARIO. ENDEIKTIKA GIA PARAVIASI ERYTHROU  
SIHATODOTI PROVLEPETAI PROSTIMO 45000 DRCH GIA PARAVIASI DAKTYLIYOU  
PROSTIMO 45000 DRCH GIA YPEVASI ORIOU TACHYTTITOS 35000 KAI GIA  
PARANOHO

PARKARISMA 20000 DRCH. EPISIS EISAGETAI METHODOS DAGKANAS GIA  
PARANOHA

STATHMEFMENA AFTOKINITA KAI THESPIZETAI THESHOS SCHOLIKOU  
TROCHONOMOY STOP

DEN YPARCHEI KANENAS KINDYNOS GIA YGEIA KATOIKON LEKANOPEDIYOU ATTIKI  
APO NERO LHMNIS MARATHONA ANAKOINOSE YPOURGEIO YGEIAS. ANAKOINOSI  
TOHIZETAI OT APO DEIGHMATOLIPSIES POU DIENERGEI EFDAP PROKYPTEI OTI  
DEN YPARCHEI PROVLIM STIN POIOTITA NEROU STOP  
KANENAS KINDYNO DEN YPARCHEI ELLINIKA PELAGI APO NARKES TOU V  
PAGOSHIYOU POLEMOU DIAPEVAIOSE DEN KAI TONIKI ULI SYMFONA ME EPISIMA  
SYMBEIBHTEI ENERGESI ACRIGIOBESKADHMATON REPOOHOBANARKAREDSON STOP  
MITSOTAKI

NTEHIREL STO NTAPOS SE OTI AFORA KYPRIAKO STOP  
EPAFES ME EKPROSOPOUS KOMMATON GIA RADIOTILEOPTIKA MESA ARCHI E  
KOUVELAS STOP

IERA SYNODOS EKKLISIAS ELLADOS EHMENEI THESI TIS OTI ROLOS PAPIKIS  
EKKLISIAS VALKANIA APOVAINEI SE VAROS ORTHODOXON EKKLISION STOP  
EKPROSOPOS AGIAS EDRAS DILOSE OTI VATIKANO DEN SCHOLIAZEI AITIA IA  
DIAKOPI DIPLOMATIKON SCHESEON KAI OTI KATEGORIES EINAI AVASIMES STOP  
NEO PROGRAMHA DANEIOTOTISIS ERGATOU PALLION GIA KATOIKIA XEKINA TO  
1992 ORGANISMOS ERGATIKIS KATOIKIAS STOP

ELPIDES OTI SYZITITHEI KYPRIAKO PROVLIMA KATA PIKEINENI SYNANTISI  
BOUS-NTEHIREL EXEFRASE AMERIKANOS GEROUSIASTIS STOP  
ANISYCHIES GIA HELLON KOINOPOLITEIAS EXEFRASE GKORMPATSOY STOP  
STO PARISI GINONTAI SY OMIILIES METAXY MITERAN-GIELTSIN GIA ELENCHO  
PYRINIKIS ERGOSTASIOY PROIN E SSD STOP

EKPROSOPOS YPEX GERMANIAS ANAKOINOSE OTI KATA DIHMERI EPISKEPSI  
PROTHYPOURGOY SKOPION GERMANIA EN PROK ITAI YPARXEI SYNANTISI ME  
Y EX

GKENSER STOP  
OUASIGKTON DEN THA ANAGNORISEI AKOMA SLOVENIA-KROATIA EOS OTOU  
VRETHEI

TROPOS SYNOLIKIS EPILYSIS GIOUGKOSLAVIKOU STOP  
STOUS SERVOS ETHNIKISTES KAI KROATES IGETES APODIDEI EFTHYNES OIE  
GIA

KATHYSTERISI APOSTOLIS KYANOKRANON STIN GIOUGKOSLAVIA STOP  
5 NEKROI KAI 7 TRAVMATIES EINAI APOLOGISHOS EPITHEISIS ENOPLON STO  
BELFAST V IRLANDIAS STOP

PREVDA THA KYKLOFOREI EFEXIS 5 IHERES TIN EVDOMADA LOGO AFXISIS TIMIS  
CHARTOU STIN MOSCHA STOP

OLYMPIAKOS NIKISE STO VOLEF PARTIZAN 3-1 SET KAI PROKRITHIKE TELIKOUS  
POU GINOUN STADIO EIRINIS KAI FILIAS STON PEIRAIA STOP  
APOTELESMATA AGONON KYPELLOU

ETHNIKOS DOXA 0-4 APOLLON OFI 0-1 PAOK KORINTHOS 4-1  
XANTHI OLYMPIAKOS 2-1 CHAIDARI ATROMITOS 0-0 ARGOS PAO 1-2  
IRAKLIS AEK 1-1. EPANALI TIKOI AGONES DIEXACHTHOUN 26-2-92 STOP

TYCHEROI ARITHHOI LOTTO 27- 1-35-9-18-32. DEN VRETHIKE KANHIA STILI  
HE 6

E ITYCHIES STOP  
TRA EZA ELLADOS

1. 180,764	2. 113,937	3. 33,433	4. 326,409	5. 5,504
6. 100,695	7. 15,223	8. 29,243	9. 31,025	10. 28,876
11. 151,145	12. 132,744	13. 144,540	14. 41,325	15. 231,290

STOP ; DE SVA SVA SVA ;  
T ELOS YXCH

Abbreviations Used In The RTTY Column

AA	Arabic
ARO	SITOR mode
BC	Broadcast
EE	English
FEC	Forward Error Connection mode
FF	French
foxes	"Quick brown fox ... "test tape
GG	German
ID	Identification/ied
MFA	Ministry of Foreign Affairs
nx	News
PP	Portuguese
RYRY	"RYRY ... "test tape
SS	Spanish
tlc	Traffic
w/	With
wx	Weather

which broadcasts "EGWR" aeronautical weather data from Croughton.

RTTY Intercepts

123.7: DCF42, PIAB, Bonn, Germany, w/nx, FEC-A/96 at 1345. (Ary Boender, NLD)

129.1: DCF45, VWD, Frankfurt, Germany, w/financial nx, 300 baud at 1355. (Boender, NLD)

147.3: DDH47, Pinneburg Meteo, Germany, w/coded wx at 1845, 50 baud. (Boender, NLD)

518: GNI, Niton, R., England, w/a Navtex b/c at 0824; GCC, Cullercoats R., England, w/Navtex rpt about a helicopter crash, at 1252; GPX, Portpatrick R., England, w/Navtex navigational warnings at 0930; & PKB, the Dutch Coast Guard, w/Navtex navigational warnings, at 1548. All were in FEC mode. (Boender, NLD) NMN, USCG, Portishead, VA; & NMG, USCG, New Orleans, LA; & NMA, USCG, Miami, FL; w/notices to mariners at 0130, 0300, & 0400 respectively. The mode in all cases is FEC. (Ed.)

2137.5: WLC, Rogers City R., MI, w/a Lake Superior wx forecast, FEC at 0132. (Harold Manthey, NY)

2845: GYA, Royal Navy, London, England, w/an availability report at 0220, 75 baud. Also seen on 2892.4 at 0225. (Fred Hetherington, FL)

3803: RFFS, French Mil., Metz, France, idling, ARQ-E/96 at 2047. ("Gal of Liberia")

3864: FMV, French Navy, Lyon, France, w/msgs to Paris, ARQ-E/72 at 1965. (Boender, NLD)

4178.5: UTRO, ship Dovgoe, w/msg re used car lot near me. The head salesman has shifty eyes, smokes a big stogie, and wears a huge diamond ring on his pinkie finger. He'll have a good deal for the entire crew—Ed.

4362.7: CCM, Punta Arenas Navrad, Chile, w/5L grps at 0407, 50 baud. (Robert Hall, RSA)

4489: GFL26, Bracknell Meteo, England, w/coded wx, 50 baud at 0425. ("Bunky," IL)

4570: UN-ID w/coded wx, 100 baud at 0420. ("Bunky," IL) It's HZN46, Jeddah Meteo, Saudi Arabia—Ed.

4583: DDK2, Pinneburg Meteo, Germany, w/RYRY at 0415, 50 baud. ("Bunky," IL)

4768.1: CCS, Santiago Navrad, Chile, w/5L grps at 0414, 100 baud. (Hall, RSA)

4880.2: GYA, Royal Navy, London, England, w/RY's & foxes, 75 baud at 0153. (Manthey, NY)

5106.5: IBA5, Italian Navy (Napoli?—Ed.), testing w/c/s IAEF, 75 baud at 0205. (Manthey, NY)

5117.4: TYE, ASEENA, Cotonou, Benin, w/??? at 0440, ARQ-M2/96, (Hall, RSA)

5160.2: IER20, Italian Customs, Rome, w/???, ARQ-M2/96 at 0457. (Hall, RSA)

5287.2: FBSK, Gaborone Aero, Botswana, w/RYRY, 50 baud at 0500. (Hall, RSA)

5740: HZN, Jeddah Meteo, Saudi Arabia, w/coded wx, 50 baud at 0410. ("Bunky," IL)

News broadcast in Greek sent by SVU5, Athens Radio Greece, on 12603.5 kHz at 0300 UTC, in FEC mode (from Robert Margolis).

**5795:** FDY, French Air Force, Orleans, France, w/RYRY & le bricks, 59 baud at 0127. (Manthey, NY)

**5847.7:** TUH, ASECNA, Adidjan, Ivory Coast, w/RYRY at 0512, 59 baud. (Hall, RSA)

**5888:** IMB32, Rome Meteo, Italy, w/a solar storm report at 0400, 50 baud. ("Bunky," IL)

**5904.5:** AFS, Offutt AFB, Elk Horn, NE, w/KAWN wx data, 75 baud at 0207/Pfitt also has a radiofax b/c on at the same time on 5980 kHz, 120/576. (Ed.)

**6835.2:** GFL22, Bracknell Meteo, England, w/coded wx, 50 baud at 0232. (Hall, RSA)

**6902.3:** TLO, ASECNA, Bangui, Central African Republic, w/coded wx, 75 baud at 0240. (Hall, RSA)

**6941.3:** TRK, ASECNA, Libreville, Gabon, w/???, ARQ-M2/96 at 0243. (Hall, RSA)

**7592.1:** YZD6, Tanjug, Belgrade, Yugoslavia, w/nx in FF at 2107, 50 baud. (Ed.)

**7626:** TZH, ASECNA, Bamako, Mali, w/RYRY, 50 baud at 0242 (Burkhart, LA), and at 0450. (Hall, RSA)

**7983.7:** RFTJ, French Navy, Dakar, Senegal, w/"controle de voie," ARQ-E3/48 at 0528. (Hall, RS)

**7998.4:** Un-ID w/tfc in SS under heavy QRM, ARQ at 0150-0205. (Hetherington, FL)

**8031:** RFXL, French Mil., Beirut, Lebanon, w/le bricks, RYRY & 10 count, ARQ-E/72 at ??? (Hetherington, FL)

**8051.5:** WOO, Ocean Gate R., NJ, w/a radiotelephone t/c list, FEC at 0320. ("Bunky," IL)

**8087:** KMI, Dixon R., CA, w/a radiotelephone t/c list, FEC at 0315. ("Bunky," IL), and at 2340. (Bjorn Vaage, CA)

**8215:** Un-ID sends many different selcals, ARQ at 0521. (Ed.)

**8297.5:** Un-ID w/telegrams in SS, ARQ at 0436. (Ed.)

**8428.5:** PCH46, Scheveningen R., Netherlands, w/a t/c list at 0115, FEC. (Ed.)

**8514:** WLO, Mobile R., AL, w/wx, FEC at 2351. (Vaage, CA)

**9190.7:** RDZ75, Moscow Meteo, Russia, w/coded wx at 1252, 50 baud. (Ed.)

**9312:** Un-ID w/very garbled text which was not encryption, 50 baud at 1237. (Ed.)

**9328.4:** XVN26, VNA, Hanoi, Vietnam, w/RYRY foll by nx in FF at 1207, 50 baud. (Hetherington, FL) Same sta. on 9330.2 w/nx in EE at 1240, also 50 baud. (Ed.)

**10150:** SUA246, MENA, Cairo, Egypt, w/RYRY at 0530, 75 baud. (Ed.)

**10162.5:** YIL71, Baghdad, Iraq, w/nx in AA, 50 baud at 2031. ("Gal of Liberia")

**10168.5:** Un-ID idling at 0527, ARQ E/72. (Ed.)

**10215.3:** HZN48, Jeddah Meteo, Saudi Arabia, w/coded wx, 100 baud at 2359 (Hall, RSA), and at 0555. (Ed.)

**10231.8:** "LYNX" w/ID in CW & ARQ phasing sig at 0000. Also heard on 11198.8 at 0210. (Hall, RSA). Interesting to hear that Lynx's sig can be copied by you. It comes in strong here in the U.S. Still need to determine its QTH—Ed.

**10417.3:** ETD3, Addis Ababa Aero, Ethiopia, w/RYRY + "How do you read?" (usually with eyeglasses—Ed.). Was 50 baud at 0425. (Ed.)

**10600:** VNA25, VNA, Hanoi, Vietnam, w/nx in EE at 1605, 50 baud. (Manthey, NY)

**10610:** SUA251, MENA, Cairo, Egypt, w/nx in FF at 2023, 50 baud. ("Gal of Liberia")

**10654.8:** MKK, RAF, London, England, w/RYRY's, foxes & 10 count on all FDM channels, 75 baud at 0620. (Ed.)

**10893.9:** LRB39, Telam, Buenos Aires, Argentina, w/nx in SS, 50 baud at 0105. (Hall, RSA)

**11039:** DDH9, Pinneberg Meteo, Germany, w/CQ foll by plaintext wx in GG, 50 baud at 0831. (Ed.)

**11133.1:** BZG41, Xinhua, Yurumqi, China, w/nx in FF at 1634, 50 baud. (Ed.)

**11139:** DFZG, MFA, Belgrade, Yugoslavia, w/nx, 75 baud at 0840 (Mark Burkhart, LA)

**11171:** Un-ID sta w "RCF" c/s w RYRY & CQ at 1732, 75 baud. ("Gal of Liberia") At the time you monitored it, it was the c/s of MFA, Moscow, USSR—Ed.

**11242:** Un-ID Egyptian diplo w/5L grps, ARQ at 0305 (Paul Scalzo, PQ, Canada)

**11335.5:** Un-ID w/coded wx, 50 baud at 0229. Do you have a call sign and a location for this sta? (Burkhart, LA) You've got me stumped—Ed.

**11476:** HMF52, KCNA, Pyongyang, North Korea, w/nx at 0529, 50 baud (Burkhart, LA). Same w/nx in EE

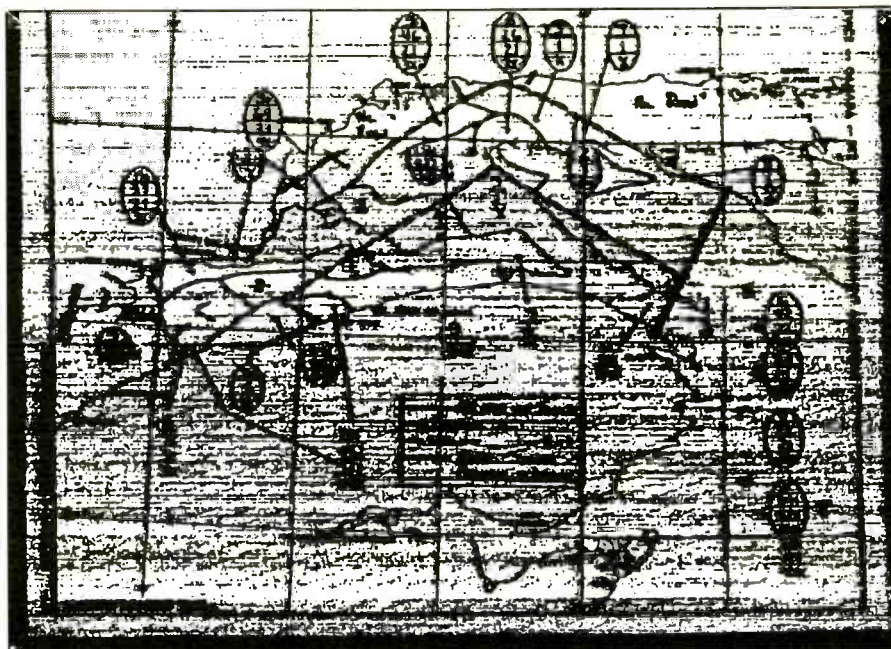

*CZW, Maritime Air Group, Halifax, NS, Canada, sent this radiofax weather chart at 1600 UTC on 14626.5 kHz, 120/576 (Printout from Robert Margolis).*

at 2043 ("Gal of Liberia")

**11486.3:** TUH, ASECNA, Anidjan, Ivory Coast, w/aero wx at 0702, 50 baud (Ed.)

**11506.7:** Un-ID idling in ARQ mode, 0132-0136 (Ed.)

**11538:** Un-ID w/encryption, ARQ at 0752 (Ed.)

**11604:** YZJ3, Tanjug, Belgrade, Yugoslavia, w/nx in EE at 0756, 50 baud (Ed.)

**11638:** DDK8, Pinneberg Meteo, Germany, w/RYRY at 0830, 50 baud (Burkhart, LA), and w/coded wx at 0415. ("Bunky," IL)

**12097:** HXV67, Hanoi Meteo, Vietnam, w/RYRY at 0041, 50 baud (Manthey, NY)

**12517.5:** Un-ID using an undetermined synchronous RTTY mode at 125 baud, at 2358. Got no syncing AR-TRAC mode (Ed.)

**12579:** NMF, USCG, Boston, MA, w/navareas & hydrolants, FEC at 0149 (Ed.), and w/wx at 2037. (Vaage, CA)

**12594:** PPR, Rio de Janeiro R., Brazil, w/ARQ phasing sig + CW ID at 0225 (Ed.)

**12597:** SPB62, Szczecin R., Poland, w/FEC synchronization sig & ID in CW at 0227 (Ed.)

**12600.5:** HEC23, Berne R., Switzerland, w/ARQ phasing sig & CW ID at 0235 (Ed.)

**12603.5:** SVU5, Athens R., Greece, w/nx in Greek at 0300, FEC (Ed.)

**12605:** LGJ4, Rogaland R., Norway, w/a t/c list at 0500, FEC (Ed.)

**12615:** UXXN, Arkhangelsk R., Russia, w/ARQ phasing sig + ID in CW at 0345 (Ed.)

**12639.5:** OST50, Oostende R., Belgium, w/ARQ phasing sig & ID in CW at 0403 (Ed.)

**12902.6:** RBSL, Bombay Navrad, India, w/RYRY, 50 baud at 1045 (Hall, RSA)

**13392:** DFZG, MFA, Belgrade, Yugoslavia, w/Tanjug nx in SC, foll by crypto after XPXPXP. Was 75 baud at 2230 (Hetherington, FL)

**13865:** RUZU, SAAM, Molodezhnaya, Antarctica, w/RYRY, 50 baud, 1530-1555 (Boender, NLD)

**13867.7:** Un-ID idling in ARQ mode, 0653-0718, then w/clerical msgs in FF, foll by a telex. Went QRT at

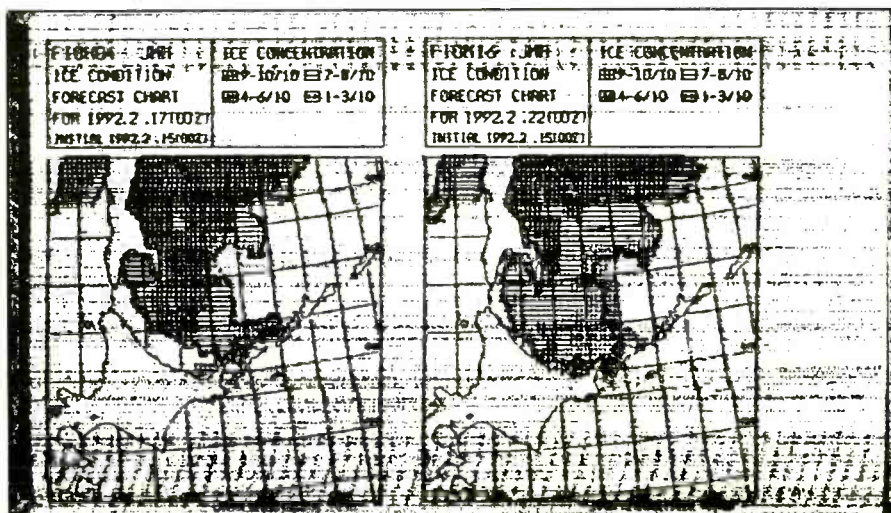

*Ice concentration radio fax chart from JMH6, Tokyo Meteo, Japan (Logged by Robert Margolis).*

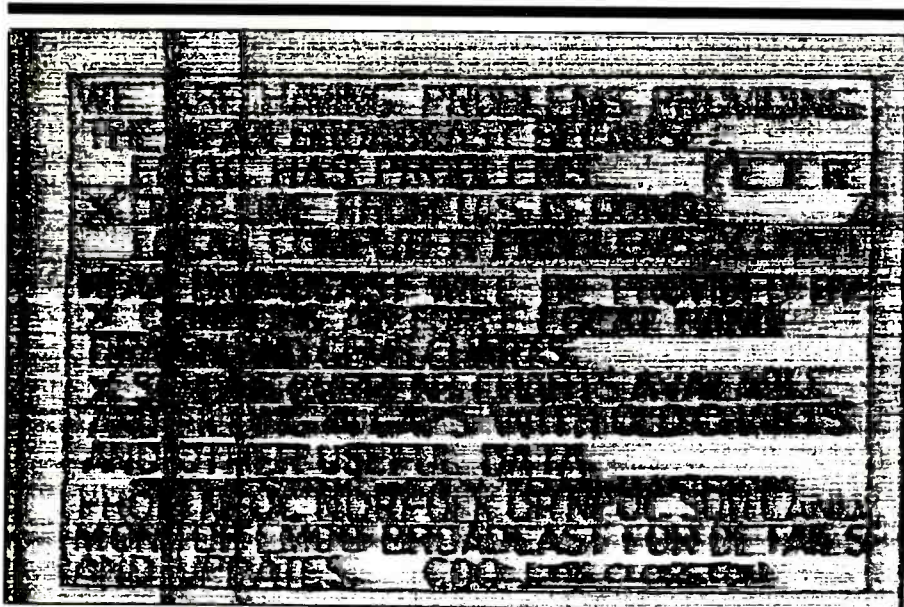

Radiofax transmission reads, "We are having problems providing the NFAX broadcast because F\_QC has problems. Data line from U.S. is down. Local computer problems. Fax broadcast will be provided by compiling Air Force local hand drawn and GEMS charts. Strong current charts available and filling in gaps with old charts and other useful data. Pro Norfolk CRNPOCS land monitor MOC broadcast for details and updates." Sent Jan. 22, 1992 by AOK, U.S. Navy, Rota, Spain, on 5785 kHz at 0227 UTC, 120/576, and logged by the RTTY columnist.

0755 Did not appear to be diplo (Ed.).

**14359:** SNN299, MFA, Warsaw, Poland, w/5L grps. 75 baud at 0820 (Burkhart, LA).

**14531:** USAF MARS stas AGA3HG & AGA61.A w MARSgrams, packet radio at 0607 (Scalzo, PQ)

**14547.5:** JAL44, Kyodo, Tokyo, Japan, w/nx in EE, 50 baud at 0800. Heavy QRM from an un-ID sta xmtng in ARQ (Burkhart, LA). Italian diplo stas using ARQ are found to xmit on 14546.5—Ed.

**14573:** 9HC67, Jana, Malta, w/nx in AA at 1630, 50 baud (Manthey, NY)

**14597:** SOO259, PAP, Warsaw, Poland, w/nx in Polish, FEC at 1757 ("Gal of Liberia"), and at 1815 (Scalzo, PQ, Canada).

**14767:** Un-ID idling for several hrs before going QRT. No wds ever seen. Was ARQ-E/72 at 0131 (Ed.).

**14772.5:** VER, Canadian Forces, Ottawa, ON, w/encryption on all FDM channels, 75 baud at 2032 (Ed.).

**14786:** 9PL, Kinshasa Aero, Zaire, w/RORY, 50 baud at 0755 (Burkhart, LA).

**14810:** GXQ, Royal Army, Stanbridge, England, w/RYY's & foxes at 0002, 50 baud (Scalzo, PQ, Canada).

**14860:** CLP1, MFA, Havana, Cuba, w/5L grps & crypto after ZZZZZ to Zambia, 50 baud at 0722 (Scalzo, PQ, Canada).

**14880:** JMG4, Tokyo Meteo, Japan, w/coded wx, 50 baud at 0710 (Burkhart, LA). Same at 1546 ("Gal of Liberia").

**14915:** 5KM, Bogota Navrad, Colombia, w/RORY & a msg in SS, 75 baud at 2038 ("Gal of Liberia").

**14928:** CLN452, PL, Havana, Cuba, w/nx in SS at 2113, 50 baud ("Gal of Liberia").

**16298.1:** Appeared to be Tanjug nx in SC from Belgrade, Yugoslavia, 75 baud at 0210. Looked for but could not find no // freq. Sta. ID came at 0230 but could not read it. Too much misprinting due to distortion (Hetherington, FL). This was DFZG, MFA, Belgrade, according to my database—Ed

**16670:** UUBL, ship Moris Bishop (Latvian tanker—Ed.), wkg Riga Radio at 1110, ARQ (Boender, NLD).

**16673:** Y5EJ, ship Riesa (German bulk carrier—Ed.), wkg Ruegen Radio, ARQ at 1230 (Boender, NLD).

**16684:** DUBF, ship Sea Bell (Philippine cargo—Ed.), w/telex tfc at 1024, ARQ (Boender, NLD).

**17036:** UXN, Arkhangelsk R., Russia, w/telegrams in RR to ships, 50 baud at 1321 (Ed.).

**17080:** UA13, Nakhodka R., Russia, w manual TTY xmsn, 50 baud at 0730 (Burkhart, LA). What was being sent?—Ed.

**17114.7:** Un-ID Egyptian diplo (ID's as "CFUW" on

Latin keyboard from an Arabic one) w "kds lkzgcg jg cfuw ods 06161 066161 06161 ky ky." Was FEC at 1951. Was sent to the Egyptian embassy at Washington, DC (ID'd as "lkzgcg") (Ed.).

**17131.7:** MFA, Cairo, Egypt, w/5L msgs & diplo texts in AA to the Egyptian Embassy, Washington, DC. Was ARQ at 1738 (Ed.).

**17138:** URB2, Klaipeda R., Lithuania, w/telegrams in RR at 1844, 50 baud. Wonder when they're going to start sending telegrams in their native lang? (Ed.)

**17140:** UMN7, Murransk R., Russia, w/RORY & telegrams in RR, 50 baud at 1906 (Ed.).

**17141:** UFN, Novorossisk R., Russia, w/telegrams in RR at 1903, 50 baud (Ed.).

**17141.6:** UBN, Zhdanov R., Ukraine, 50 baud at 0721 (Burkhart, LA). What tfc did you see???—Ed.

**17163:** RNO, SAAM, Moscow, Russia, w/???, 50 baud at 0740 (Burkhart, LA), and w/msgs at 1600 (Boender, NLD).

**17454.7:** Un-ID French diplo w/a 5L msg, ARQ6-90/200 at 1410 (Ed.).

**17532.3:** HDN, Quito Navrad, Ecuador, w/RORY & SSG + msgs in SS to YWM, 75 baud at 2114 (Ed.).

**17532.3:** HZN49, Jeddah Meteo, Saudi Arabia, w/coded wx, 100 baud at 1927 (Ed.).

**18007.8:** Egyptian Embassy, Harare, Zimbabwe, w/a lengthy 5L msg to Cairo at 1104, ARQ (Hall, RSA).

**18035.3:** JAT28, Kyodo, Tokyo, Japan, w/nx in EE at 0309, 50 baud (Ed.).

**18129.6:** JMJ5, Tokyo Meteo, Japan, w/coded wx, 50 baud at 1558 (Hall, RSA).

**18164.5:** STK, Khartoum Aero, Sudan, w/coded wx & Notams, 50 baud at 1538 (Boender, NLD).

**18173.6:** STK, Khartoum, w/RORY at 2054, 50 baud. New freq (Ed.).

**18212:** "TDXZF" w/RORY at 1417, 50 baud (Boender, NLD).

**18341.7:** Egyptian Embassy, Bamako, Mali, w/5L grps, ARQ at 1715 ("Gal of Liberia").

**18496:** CNM80, MAP, Rabat, Morocco, w/RORY & skeds, 509 baud at 1150 (Boender, NLD).

**18598:** Un-ID diplo sending tfc from embajada Amman" to "embajada Teheran, Tel Aviv, Bonn," ARQ at 0900 (Boender, NLD).

**18755.8:** JPA24, Interpol, Tokyo, Japan, w/police bulletins, ARQ at 0213 (Ed.).

**19171:** CNM85X11, MAP, Rabat, Morocco, w/nx in FF at 1637, 50 baud ("Gal of Liberia").

**19444.8:** CLP1, MFA, Havana, Cuba, w/encryption at 1953, 50 baud ("Gal of Liberia").

## IMPROVE RECEPTION

### SUPER SCANNER STICK

Only \$80

Get great scanner reception with our SUPER SCANNER STICK. Covers all scanner bands (25-1200MHz) Only 35" long. Powerful 15db amplifier. 25' of cable supplied with connector for your scanner.

SCANNER STICK Same as above but without booster amplifier \$40

CELLULAR reception unsurpassed! Our new SUPER DANA antenna combines a 9db gain antenna with 15db amplifier for fantastic 800-950MHz reception. SUPER DANA \$80



### ANTENNA PLUS

\$90

Make your receiver spring to life! Receives like the large antennas yet sits on your table! Strong internal 15-22db amplifier! 115VAC pwr. Cable to rcvr. INCLUDED!

ANTENNA PLUS-1 0.3-1200MHz "All Bands" (for wide coverage rcvr.)  
ANTENNA PLUS-2 0.3-30MHz "Short-Wave" (peaked for SWL's)  
ANTENNA PLUS-3 25-2000MHz "Scanner" (peaked for VHF-UHF)

AM BROADCAST LOOP ANTENNA	SHORTWAVE ANTENNAS
Fantastic AM (5-2MHz) reception without bothersome noise! Easily null out interference! Compact desktop unit with internal amplifier. BCL-1 \$125	Super reception with the MULTIWIRE-4! 0.3-30MHz and 130' long for FULL SIZED performance! MW-4 \$100  Fine reception 2-30MHz with our BW-60 SWL antenna. Only 60" long and only \$40! SALE \$35 till 9/1/92!

**MOBILE SCANNER & WORLDWAVE ANTENNAS!**  
Suction cup mounted for easy installation! SUPER models have internal preamplifier for strongest signals. Models for "ALL BAND" (0.53-1200MHz), "SWL" (53-30MHz) and "SCANNER-FM-TV" (25-1200MHz). Order SIGNAL SCOOP \$45 or SUPER SIGNAL SCOOP (with amp) \$80

**LISTEN TO HOURS OF SCANNING IN MINUTES!**  
Our TAPE SAVER interface makes your recorder operate only when there's action on your scanner. Tape Saver TS-1 \$60

Continuum US Shipping/Handling \$5, Canada, AK, HI, PR \$8. NY and MI add sales tax.

**MANY NEW PRODUCTS CALL FOR DETAILS!**

**EP** ELECTRON PROCESSING, INC.  
PO BOX 68 CEDAR, MI 49621 (616) 228-7020

CIRCLE 24 ON READER SERVICE CARD

# SUPER LONG PLAY TAPE RECORDERS

## 12 Hour Model — USES 120 TAPE \$119.00\*

Modified Panasonic Slimline, high quality AC-DC provide 6 continuous hours of quality recording & playback on each side of cassette for 12 hours total. Includes • Voice level control • Digital counter, etc. TDK — 120 Cassette Furnished.

### PHONE RECORDING ADAPTER

Records calls automatically. All Solid state connects to your telephone jack and tape recorder. Starts recording when phone is lifted. Stops when you hang up. **\$28.50\*** FCC APPROVED

### VOX VOICE ACTIVATED CONTROL SWITCH

Solid state. Self contained. Adjustable sensitivity. Voices or other sounds automatically activate and control recorder. Uses either remote control or remote mike. **\$28.50\***

\* Add for ship. & handling. Phone Adapter & Vox \$2.00 each. Recorders \$5.00 each. Calif. Res. add tax. Mail order. VISA, M/C, COD's OK. Money Back Guarantee. Free data. available. Dealer Inquiries invited. Free data.

**AMC SALES INC.** Dept. 9335 Lubec Street  
Box 928, Downey, CA 90241  
Phones (310) 869-8519 1-800-926-2488  
FAX (310) 923-1478  
Mon-Fri 8-5 PAC. TIME

CIRCLE 25 ON READER SERVICE CARD

**19529:** JMG5, Tokyo Meteo, Japan, w/coded wx, 50 baud at 1810 (Scalzo, PQ, Canada).

**19592:** IRR35, ANSA, Rome, Italy, w/nx in II, 50 baud at 1538 (Ed.).

**19649:** Un-ID w/5F grps, 75 baud, foll by "QRUSK" at 1450 (Hetherington, FL) My database shows only RCF, MFA, Moscow, ex-USSR, listed on this freq at 75 baud—Ed.

**19685.5:** WLO, Mobile R., AL, w/an ARQ phasing sig & ID in CW at 155 (Ed.).

**19698:** OST69, Oostende R., Belgium, w/an ARQ phasing sig & ID in CW at 1556 (Ed.).

**19748:** 6VU79, Dakar Meteo, Senegal, w/coded wx, 50 baud at 1438 (Ed.).

**19821.5:** Un-ID United Nations post b/foxes & 10 count, + clerical msg, 1916-1932, ARQ. On another day, the UN sta at Monrovia, Liberia, w/msg re the storming of Monrovia's police sta during violence there. ARQ at 1838 (Ed.).

**19865.6:** YZJ4, Tanjug, Belgrade, Yugoslavia, w/nx in SC at 1801, 50 baud (Ed.).

**19980:** 9BC33, IRNA, Teheran, Iran, w/nx in EE at 1715, 50 baud (Ed.).

**20101.2:** Un-ID Egyptian diplo w/tfc in AA, ARQ at 1341 (Ed.).

**20132:** DFZG, MFA, Belgrade, Yugoslavia, w/nx in SC, 75 baud at 1524 (Ed.).

**20233.2:** Un-ID w/several 5L & 5F msgs at 1350, 50 baud (Ed.).

**20418:** Un-ID idling at 0551, ARQ-M2/96 (Burkhart, LA) My database shows this freq. to be a German diplo channel using ARQ-E/96—Ed.

**20446:** CXR, Montevideo Navrad, Uruguay, w/RYRY & SGSG to YWM, 75 baud at 1950. Appeared to be a spur of 20470, along with one on 20494. Both spurs were 24 kHz on either side of the fundamental freq., which had the weakest sig of the three (Hetherington, FL).

**20628:** CLP9, Cuban Embassy, Aden, Yemen, w/5L grps & t/c in SS, 50 baud at 1445 (Burkhart, LA).

**20838:** Either MFA, Sofia, Bulgaria, or the Bulgarian Embassy, Washington, DC, w/crypto after DDDDD, 75 baud at 1500 (Hetherington, FL).

**20907.5:** Un-ID North Korean diplo w/text in KK, 50 baud at 2053 (Manthey, NY).

**20986.8:** SAM, MFA, Stockholm, Sweden, w/nx in Swedish to its embassy in Washington, DC. Was SWED-ARQ at 1515 (Hetherington, FL).

**21729.7:** Cuban Embassy, Lima, Peru, w/5L msgs at 1600, 50 baud (Joe Palkovic, FL, via Hetherington, FL).

**21734.5:** CLP1, MFA, Havana, Cuba, w/5L grps at 1625, 50 baud (Palkovic, FL via Hetherington, FL).

**21828.5:** MFA, Madrid, Spain, w/diplo t/c in SS, ARQ at 1612 (Ed.).

**21844.6:** Un-ID w/TVPX & TVPQ seicals in ARQ at 1651 (Ed.).

**21856:** Un-ID idling in ARQ mode, 1656-1717, then gives QSL & goes QRT. 2nd sta. then heard on this freq. before it went QART a few seconds later. The 1st sta. must've been receiving t/c from the 2nd (Ed.).

**21927.2:** Un-ID French diplo w/encryption, ARQ-90/200 at 1638 (Ed.).

**22193:** 5LWH, ship Dragonland (Liberian bulk carrier—Ed.).

**22295.7:** KGWU, Thomas Washington (U.S. oceanographic research ship), w/msgs to WWD, Scripps Bucom Fisheries, La Cholla, CA. Was ARQ at 1744 (Ed.).

**22376:** NMA, USCG, Miami, FL, ending some kind of b/c at 2053, FEC. NMO, USCG, Honolulu, HI, w/hydropac b/c at 2230, FEC. This is a worldwide maritime safety info freq (Ed.).

**22422:** GYA, Royal Navy, London, England, w/availability report, 75 baud at 1150 (Boender, NLD).

**22880:** Un-ID in ARQ6-90/200 mode at 1730. Sig was buried under loud buzz saw, non FDM, type noise (Ed.).

**22897:** "6XMB" w/RYRY to "C37A," foll by "QSY25," a pause, and "RRR." Was 100 baud and went off the air at 1614 (Hetherington, FL).

**23006.7:** Egyptian Embassy, Kampala, Uganda, w/tfc in AA to Cairo, ARQ at 1431 (Ed.).

**23037.3:** Un-ID Egyptian diplo w/a s/off msg in AA, ARQ w/an 850 Hz shift, at 1357 (Ed.).

**23040:** KNY32, Bulgarian Embassy, Washington, DC, w/tfc in Bulgarian & 5F grps, 75 baud at 1511 (Ed.).

**23051.5:** CLP25, Cuban Embassy, Maputo, Mozambique, w/crypto after ZZZZZ, 100 baud at 1524 (Ed.).

**23561.7:** PCW7, Dutch Embassy, Damascus, Syria,



DEPARTMENT OF THE AIR FORCE  
HEADQUARTERS AIR FORCE GLOBAL WEATHER CENTRAL  
OFFUTT AIR FORCE BASE, NEBRASKA 68113-5000

17 OCT 1991

Dear Mr Anders

The High Frequency Regional Broadcast (HFRB) system is an Air Force communications system consisting of 10 KW transmitters at eight sites worldwide. It was designed as a contingency and exercise communications system that broadcasts facsimile and teletype data continuously and simultaneously. Two sites (Elkhorn, Nebraska and Homestead AFB, Florida) cover the continental US; the other sites are located overseas and in Alaska. Facsimile data are broadcast on the upper sideband and teletype data are broadcast on the lower sideband. Broadcast range is approximately 2,000 miles, depending on wave propagation conditions. Air Weather Service periodically directs that the data be encrypted. Operating frequencies for the Elkhorn HFRB are 3231, 5096, 6904, 10576, 11120, and 19326 Khz. Frequencies used depend on mission requirements and atmospheric conditions affecting HF propagation. Frequencies are normally changed at sunrise and sunset to compensate for diurnal fluctuations in HF propagation.

For your information, Air Force Global Weather Central (AFGWC) is not responsible for operation of the HFRB system. AFGWC is a source for some of the fax products transmitted by HFRB. Any other questions you have should be directed to: Air Weather Service, Public Affairs Office, Scott AFB IL 62225-5008.

Sincerely

JAMES P. MILLARD, Major, USAF  
Chief, Current Operations Branch

Figure 2

w/msgs in Dutch, ARQ at 1450 (Ed.).

**23564.3:** Un-ID North Korean Embassy, w/text in KK & 5F grps, 50 baud at 1520. Sig begins fadeout at 1547 and is gone a minute later (Ed.).

**23607.7:** Un-ID w/encryption, ARQ at 1435 (Ed.).

**23697.7:** Un-ID w/encryption, 96-baud asynchronous mode at 1438. Had an S9 sig (Ed.).

**23772:** Un-ID idling for over an hour in ARQ-E/96 mode. Tuned in at 1541. Could be an Italian diplo because of next item on neighboring freq (Ed.).

**23773:** Italian Embassy, Buenos Aires, Argentina, w/telexes in II & 5L msgs to Rome, ARQ-E/96 at 1556 (Ed.).

**23818.6:** MFA, Lisbon, Portugal, w/5L msgs to Luanda, Angola, at 1314, ARQ (Ed.).

**23972:** JMG6, Tokyo Meteo, Japan, w/wx rpts from commercial airliners. 50 baud at 0020 (Ed.).

**23977:** LOL, Buenos Aires Navrad, Argentina, w/crypto & msgs to LOR, 75 baud at 1335 (Ed.).

**24077.2:** CLP45, Cuban Embassy, Luanda, Angola, w/nx in SS at 1600, 75 baud (Ed.).

**24101.2:** DFZG, MFA, Belgrade, Yugoslavia, w/Tanjung nx in SC, at 1442, 75 baud. Also found w/a nx b/c in SC on 24102 at 1536 on another day (Ed.).

**24171.4:** Un-ID, but possibly SPW, Warsaw R., Poland, w/telexes in Polish at 1616, ARQ (Ed.).

**24790.1:** ISX24, ANSA, Rome, Italy, w/nx in EE, 50 baud at 1546 (Ed.).

**25012.6:** MTO, Royal Navy, Rosyth, England, w/an availability report at 1609, 75 baud (Ed.).

**25022.1:** DFZG, MFA, Belgrade, Yugoslavia, w/nx in SC at 1615, 75 baud (Ed.).

**23079.2:** SAM, MFA, Stockholm, Sweden, w/text in Swedish, SWED-ARQ at 1414 (Ed.).

**23084.5:** CLP1, MFA, Havana, Cuba, w/5F grps & diplo t/c to African embassies, 50 baud at 2119 (Ed.).

**23112.3:** Un-ID w/crypto that ended w "QRU QSL? OK GB HKC AS SK." Was 75 baud at 1341 (Ed.).

**23116.7:** Egyptian Embassy, Conakry, Guinea, idling in ARQ mode at 1418. On another day, un-ID Egyptian diplo w/tfc in AA to Conakry, FEC at 1406 (Ed.).

**23165:** North Korean Embassy, Paramaribo, Surinam, w/telexes in KK, 50 baud at 1652 (Ed.).

**23181:** MFA, Oslo, Norway, w/diplo nx in Norwegian, ARQ at 1308 (Ed.).

**23191.7:** Un-ID idling in ARQ-E3/96 mode at 1306. Off the air at 1410 w/o saying a word (Ed.).

**23193.6:** Possibly RAF, Croughton, England, w/"EGWR" wx data, 75 baud at 1307. Have been seeking an ID for more than a year (Ed.).

**23349.3:** CLP8, Cuban Embassy, Conakry, Guinea, w/diplo9 t/c to Uganda, 50 baud at 1850 (Ed.).

**23355.2:** CLP18, Cuban Embassy, Dar-es-Salaam, Tanzania, w/RYRY, foll by 5F grps & msgs in SS to CLP1. Was 50 baud at 1832 (Ed.).

**23390:** LOL, Buenos Aires Navrad, Argentina, w/msgs in SS at 1857, 75 baud (Ed.).

**23451.7:** Un-ID s/off w " ... moyen ezali e awa nil ri 5/5 svp." Was ARQ at 1439. Any thoughts, gang? (Ed.).

**23509.7:** Un-ID North Korean diplo w/5F msgs & diplo txt in KK at 1559, 59 baud (Ed.).

**23513.5:** Un-ID North Korean diplo w/5F msgs at 1509, 50 baud (Ed.).

**23554:** IPG20, MFA, Rome, Italy, w/tfc in II to Brasilia, Brazil, ARQ-E/96, 1526-1550 (Ed.).

**25227:** HBD20, MFA, Berne, Switzerland, w/text in FF & GG, ARQ at 1448 (Ed.).

**25460.2:** Un-ID French diplo w/5L grps, ARQ6-90/200 at 1506 (Ed.).

**26122.4:** Kaliningrad R., Russia, w/ "LYCO de UJY" in ARQ at 1634 (Ed.).

## Getting Started in Digital Communications — Part 1

Falling equipment prices and increased hardware availability have dramatically increased the number of hams who are “digitally active.” This month’s column takes a brief look at the hardware and software required to get started, and an upcoming column will examine what you can do with today’s digital modes.

The first digital mode that comes to mind for most new hams is packet radio. Next come RTTY and AMTOR, but how many will remember to include Morse code? After all, Morse is the granddaddy of digital communications! Like many other digital modes, Morse code can be sent at high speeds and it makes efficient use of available spectrum.

In the not-too-distant future, hams will even transmit digital audio signals and a host of modes that are only experimental today. The bottom line is: digital modes are here to stay, so why not get a jump on the future and start having fun right now?

### The Gear You’ll Need

For HF operation, you’ll find that most modern transceivers easily accommodate the digital modes. If you’re considering Mode-A ARQ AMTOR (that *chirp-chirp-chirp* sound you hear below the SSB subbands), make sure your rig can switch from transmit to receiver very rapidly. Mode-A AMTOR requires a transmit/receive turnaround time of 20 milliseconds or less.

If you’re interested in RTTY, you’ll need a rig that can tolerate *high-duty-cycle* transmissions for extended periods of time. (CW and SSB are *low-duty-cycle* modes because they cause the transmitter to produce full output for only brief intervals.) Most modern rigs are rated for high-duty-cycle use, but some must be operated at reduced output.

Older rigs are often less tolerant of high-speed switching and high-duty-cycle transmissions. Mode-A AMTOR is impossible on many vintage radios. Most older SSB transmitters and transceivers should be RTTY compatible—although you’ll have to be careful not to exceed their specifications for continuous output power!

Here’s an easy rule of thumb for selecting an HF transceiver for digital applications: If you intend to operate packet or Mode-A AMTOR, buy a rig that was manufactured within the last five to ten years. If your only interest is RTTY, almost any good-quality radio made within the last 20 years will do the job.

### VHF/UHF Radios

On VHF and UHF, packet is the king of digital communications. Because packet transmissions are relatively brief, you don’t

have to be concerned about duty cycles and output-power ratings.

Although FM transceivers are designed to transmit and receive human speech, most models also function well as packet radios. Nearly any VHF FM transceiver—base, mobile or hand-held—will work just fine.

### The Computer

With all due respect to owners of Apple, Commodore, Atari and other computer brands, it’s fair to say that IBM PC compatible computers have become the *de facto* standard in Amateur Radio. This doesn’t mean that other models are unusable for digital communications, though. If you can get a terminal-emulation program for your computer, you’re halfway there.

The second hurdle involves getting your computer to talk to you TNC or MCP (short for terminal node controller, the interface that lets you computer “speak” packet; and multimode communications processor, a term that describes a modern interface that allows you to work packet, RTTY, AMTOR, SW and so on with one “box”). Most TNC and MCP manufacturers provide information to assist you in wiring your computer to their devices.

Virtually any personal computer is sufficient to get you off and running. There are few factors to consider before making your choice, however:

**I/O (input/output):** Does the computer have an RS-232C serial port? Most digital interfaces require one.

**Software:** Is there a terminal-emulation program available for the computer?

**Memory:** How much random-access memory (RAM) is available? When it comes to RAM, the more the merrier.

**Data Storage:** Does the computer offer some form of reliable data storage (preferably floppy disks or a hard disk)?

**Interference:** Does the computer bombard your receiver with RF of its own making? How does it respond to your radio signals? Interference can be a major headache!

**Support:** If your computer suddenly becomes demented, is there anyone on the planet who remembers how to fix it?

The computer that’s best for you will ultimately depend on your budget and your goals. If you’re a little unsure about digital communications, start small and work your way up.

### The Analog/Digital Interface

Getting your computer to talk to your radio is the job of the interface, which must accept digital data from the computer and translate

it into audio signals (or on/off keying) for the transceiver, and vice-versa. Whether your talking about a packet-only TNC or the latest whiz-bang MCP, you’re really talking about a modem—much like the ones used to link computers via telephone.

### Multimode Communications Processors

As digital technology evolved, it wasn’t long before someone said, “Why should I have to use one interface for packet and another for RTTY? Why can’t they all be together in one box?”

Not only did manufacturers place packet and RTTY together in the same box, they added several other modes for good measure. The result was the *multimode communications processor* (or MCP)—probably one of the most popular pieces of equipment for the digital ham today.

Like packet TNCs, MCPs incorporate microprocessor design and internal memory. By issuing a single command from the computer keyboard, you can switch the MCP from packet (HF or VHF), to AMTOR, to RTTY or even CW. Some models also add fax, ASCII, NAVTEX and SSTV to their list of modes.

MCPs have brought a smorgasbord of operating modes within the reach of average hams. Their sheer convenience is addictive!

### Digital Signal Processing

Now that you’ve been introduced to MCPs, it’s time to tell you about an exciting new technology called *digital signal processing* or DSP—an entirely digital approach to decoding and encoding signals for various modes. Its main advantage is its flexibility.

For example, you can add a new digital mode to a standard MCP by replacing an IC chip that has been programmed with new software. This is fine as long as the unit can support the new mode. But what if you want the processor to perform a task that’s beyond the capability of its existing hardware?

With a DSP processor, you can add virtually any mode to the unit by simply adding new software. Unlike standard communications processors, DSP units use software to directly encode and decode signals without depending on specialized hardware. The finer details are well beyond the scope of this column, but you’ll be hearing a lot more about DSP in the months to come.

For detailed information on operating the digital modes, check out Chapter 9 of *The ARRL Operating Manual*. It’s available from your favorite distributor or from ARRL HQ.

## SIMPLE ANTENNAS AND ACCESSORIES FOR SIGNAL IMPROVEMENT

This is the first installment of a new bi-monthly antenna column in *Popular Communications*. In future installments I will take a look at different antennas that operate in various popular bands from DC to daylight (well, maybe not quite that broad!) for short-wave listeners, VHF/UHF monitor/scanner listeners, BCB and VLF DX'ers, and others. I will also do a few product reviews of both antennas and antenna related accessories. There may even be a construction project or two... antenna related, of course.

What the column will *not* cover are non-antenna related topics and ham radio antennas. There is plenty of material around on ham antennas, including articles in *CQ* magazine, so we will not cover antennas for these bands. The thrust of the articles in this column will be practical. Antennas theory will be kept to a minimum (in fact, a deep null), while "how-to" build-it will be covered in depth. Most of the antennas that I will cover in this column either I personally, or any of several close friends, have built and tested. I welcome your input: suggestions, brickbats, kudos or bribes can be sent to me either c/o

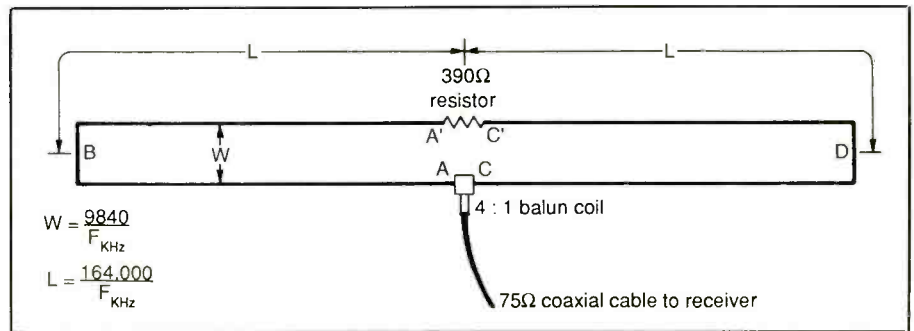

Figure 1

the editor, or at P.O. Box 1099, Falls Church, VA 22041. Now let's get down to brass tacks.

### Build the TCFTFD Dipole

Several different "standard" high frequency (HF) antennas are used by shortwave listeners, but random length wires and dipoles are by far the most common. Both of these antennas are susceptible to noise pick-up

from the local environment, with the random length wire being more susceptible than the half wavelength center-fed dipole. In addition, the dipole is rather long at low frequencies. For example, a 49-meter ( $\approx 6000\text{kHz}$ ) dipole antenna is on the order of 77 feet long. The *tilted, center-fed, terminated, folded dipole* (TCFTFD, also sometimes called the T<sup>2</sup>FD or TTFD) is an answer to both the noise pick-up and length problems (the over-

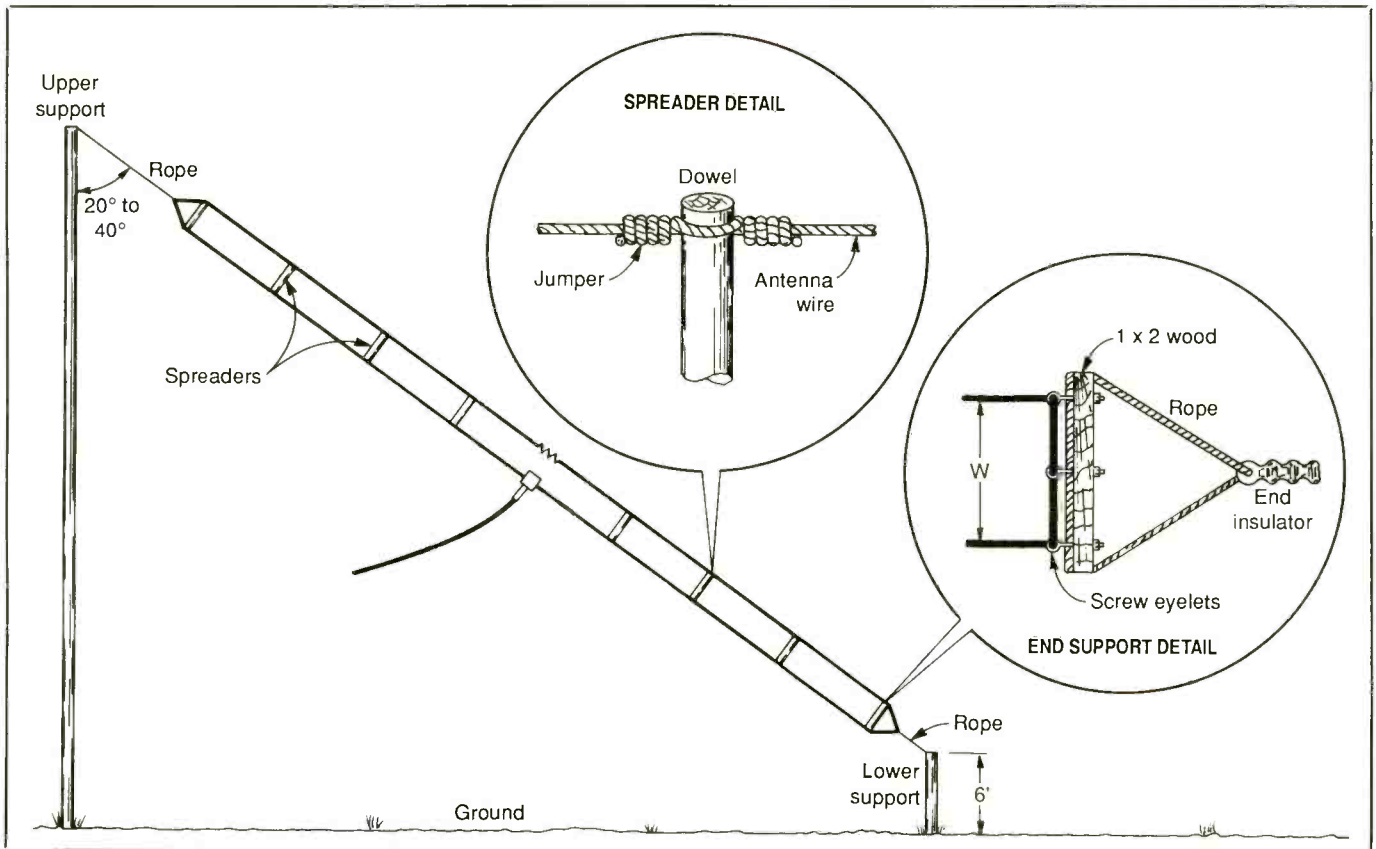

Figure 2



**Table 1**  
**Dimensions For Other Bands**

Band	Length (L)	Spread (W)
41-m	23"	16.5"
31-m	16'11"	12"
25-m	13'11"	10"
22-m	12'	8.6"
19-m	10'8"	7.75"
16-m	9'3"	6.75"
13-m	7'7"	5.5"

all length for a 49-meter TCFTFD antennas is 54 feet). This antenna was first described in public in 1949 by Navy Captain C.L. Countryman, although the U.S. Navy tested it for a long period in California during World War II. The TCFTFD can offer claimed gains of 4 to 6 dB over a dipole, depending on the frequency and design, although 3 dB is probably closer to the mark.

In addition, the TCFTFD can also be used at higher frequencies than its design frequency. Some sources claim that the TCFTFD can be used over a five or six to one frequency range, although my own observations are that four to one is more likely. Nonetheless, a 49-meter antennas will work over a range of 6,000 kHz to 25,000 kHz, with at least some decent performance up into the 11-meter Citizen's Band.

The basic TCFTFD antenna, shown in Fig. 1, resembles folded dipole in that it has two parallel conductors, of length "L," spaced a

distance "W" apart, and shorted together at the ends. The feedpoint is the middle of one conductor, where a 4:1 BALUN coil and 75-ohm coaxial cable transmission line to the receiver are used. A non-inductive, 390-ohm resistor is placed in the center of the other conductor. This resistor can be a 1-watt or 2-watt carbon composition or metal film resistor, by **MUST NOT** be a wirewound resistor. The TCFTFD can be built from ordinary #14 stranded antenna wire.

For a TCFTFD antenna covering 49 through 11 meters, the spread between the conductors should be 19½ inches, while the length (L) is 27 feet. Note that length L includes one-half of the 19-inch spread because it is measured from the center of the antenna element to the center of the end supports.

Construction of the antenna is shown in Fig. 2. The TCFTFD is a sloping antenna, with the lower support being about 6 feet off the ground. The height of the upper support depends on the overall length of the antenna. For a 49-Meter design the height is on the order of 50 feet.

The parallel wires are kept apart by spreaders. At least one commercial TCFTFD antenna uses FVC spreaders, while others use ceramic. You can use wooden dowels of either 1-inch or 5/8-inch diameter, although a coating of varnish or urethane spray is recommended for weather protection. Drill two holes, or a size sufficient to pass the wire, that are the dimension "W" apart (19-inches for 49-Meters). Once the spreaders are in place,

take about a foot of spare antenna wire and make a jumper to hold the dowel in place. The jumper is wrapped around the antenna wire on either side of the dowel and then soldered.

The two end supports can be made of 1x2 wood treated with varnish or urethane spray. The wire is passed through screw eyes as shown in the inset to Fig. 2. A support rope is passed through two holes on either end of the 1x2, and then tied off at an end insulator.

The TCFTFD antenna is noticeably quieter than the random length wire antenna and somewhat quieter than the half wavelength dipole. When the tilt angle is around 30 degrees, the pattern is close to omnidirectional. Although a little harder to build than dipoles, it offers some advantages that ought not be overlooked. The dimensions given above will suffice when the "bottom end" frequency is the 49-Meter band, and it will work well on higher bands. For other bands (and higher) use the dimensions in Table 1.

*Joe Carr is a well-known technical writer with a quarter century of experience. He is employed as an electronics engineer, and worked for 16-years as an electronics technician. He is a ham radio operator, and has held the callsign K4IPV since 1959. His shortwave listening activities go back to 1957 when he used a Knightkit regenerative shortwave receiver, which was soon replaced by an aged Hallicrafters S-20R. Today, his equipment is a bit better. Joe is the author of Practical Antenna Handbook (TAB Books, Blue Ridge Summit, PA 17294-0850; Catalog no. 3270, \$21.95; 1-800-233-1128) and the forthcoming Joe Carr's Receiving Antennas Handbook (HighText Publications, Inc. 7128 Miramar Road, #15, San Diego, CA 92121.)*

## Improve Your Scanning Coverage!

GRE America is proud to introduce a new family of products to enhance your scanning pleasure! First, GRE has designed the new **Super Converter 9001** for base model scanners. The 9001 converts 810 MHz - 950 MHz down to 410 MHz - 550 MHz. The 9001 is the perfect alternative to buying a new, expensive scanner covering the 800 MHz band. Next, GRE announces the new **Super Amplifier 3001** for base model scanners. The 3001 will increase gain by as much as 20 dB, and is engineered to help scanners with low sensitivity pull in weak signals. Both products use BNC connectors, (1) 9 volt battery and have an off/pass switch for returning to normal operation.



Super Converter 9001 & Super Amplifier 3001



Super Converter II



Super Amplifier

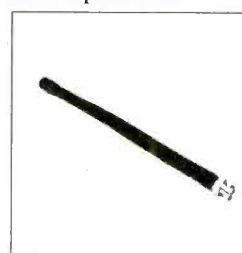

All-Band Antenna

*U.S. & International Distributorship inquiries welcome. Please call GRE for further information!*

### Let GRE Manufacture Your Radio Products!

GRE America, Inc. is a leading OEM developer and manufacturer of radio telecommunications products such as:

- Cordless Telephones
- CB & Marine Radios
- Spread Spectrum "engines"
- Remote Monitoring Systems

If you need a high quality, cost competitive, reliable manufacturer, GRE will provide you with a free production quotation.

**For more information, please call GRE at (800) 233-5973.** GRE is a subsidiary of General Research of Electronics, Inc.

**GRE** GRE America, Inc.

GRE America, Inc.

425 Harbor Blvd., Belmont, California 94002

(415) 591-1400 Outside California: (800) 233-5973

# BROADCAST DX'ING

BY ROGER STERCKX, KVT1JH

DX, NEWS AND VIEWS OF AM AND FM BROADCASTING

**Gone, But Not Forgotten:** Last year, two related broadcasters in Herkimer, New York, went dark. These were WYUT/1420, and WMYL/92.7 (ex-WYUT-FM). These stations played old favorites and big band hits, but eventually they ran into rough financial problems. It ended up with \$240,000 in liens and judgments from the landlord, the stations' news service, and the tax collector. That's when operations ceased.

These stations did have an devoted audience, though. One couple, former listeners from nearby Middleville, has been trying to arrange to put the stations back on the air. They said they aren't interested in making any money, just returning this type of music to the airwaves for the many area people who enjoyed it so much.

Last February they were attempting to see if they could take over the licenses of the stations without also having to assume the previous owner's debts and liens. With prompt FCC and court approval, the stations might even be back on the air by the time you read this.

Plans included upping the AM power to 5 kW, and putting up a new AM tower north of Herkimer, on Steuben Hill. Both stations would simulcast on a 24-hour basis, retaining the same format of music from the 1940 to 1970 era.

Temporary studios were being planned in the new owner's home in Herkimer. Some of the former deejays were being asked to return to work at the revamped station in the event all of the pieces of the deal fall into place as planned.

We appreciate this information from Gary K. Hamlin, N2OHO, and Registered Monitor KNY2AAW, of Utica, NY.

**Format Matters:** As you may know, American stations have been known to change formats practically on the spur of the moment. It's a matter of audience and advertiser response, ratings, and what management decides. You may not know that Canadian broadcasters must face their formats with considerably more respect.

According to a piece by Fred Langan in *The Christian Science Monitor*, stations in Canada have their formats listed with the federal government. It used to take more than six months of paperwork to get a format changed, but recently relaxed regulations have made format changes a little easier.

At least a station can mix soft and hard rock now and not run afoul of the rules. On the other hand, if a rock or a country station decided to run out too much folk music, or classical music, they could easily tangle with even the most liberalized rules. Under the present rules, a station is obligated to play at least 70 percent of its music from within its registered



*"3WE" isn't in Australia, it's really WWWE/1100, Cleveland, with a big-big signal heard from coast-to-coast. (Courtesy J.J. Bial, OH.)*



*Here's a station that you've probably heard, Louisville's WHAS/840. (Courtesy R.C. Watts, KY.)*

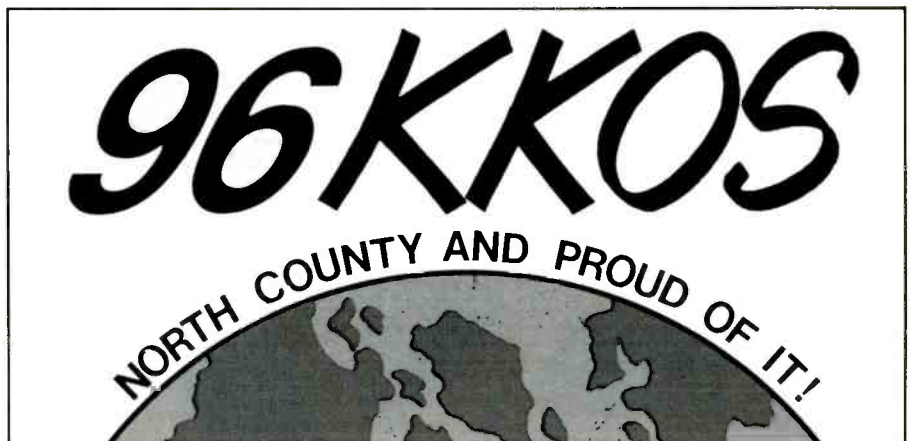

*KKOS, of Carlsbad, Calif., has a bumper sticker with environmental ideas printed on the reverse side. (Courtesy Steven O. Sellers, News Director KIOZ, San Diego, CA.)*

format. The other 30 percent can be from any format.

But that's not all, according to Langan. He mentions that the revised rules call for an increase in Canadian program content to 30 percent. It used to be 20 to 25 percent, which depended on the location of the station. Stations are unhappy about this change, which they see as restrictive, complex, and confusing.

The specific definition of what music counts as Canadian isn't always clear to station owners. Canadian Bryan Adams has an album

regarded by the government as not being Canadian because the songs were co-authored by the recording's British producer. A song recorded by American Bonnie Raitt is considered Canadian because it was written by a Canadian. A number of smaller stations needed to hire an extra staff member especially to keep up with such matters, because the government watches for violations.

Other regulations do not allow computer-operated stations, and restrict small independently-owned stations from linking up to do network programming.

### Applications For AM Facility Changes

KDBS	Eugene, OR	960 kHz	Drop nites to 215 watts.
WNWZ	Germantown, TN	1430 kHz	Drop days to 2.5 kW.

### Changed AM Facilities

KFLG	Bullhead City, AZ	1000 kHz	Dropped to 1 kW.
KTIM	Wickenburg, AZ	1250 kHz	Dropped to 350 watts.
WCEG	Middleborough, MA	1530 kHz	Increased to 1 kW.

### Applied For FM Frequency Change

KDBH-FM	Natchitoches, LA	97.7 MHz	Move to 97.3 MHz.
KSAY	Ft. Bragg, CA	97.7 MHz	Move to 98.5 MHz.
WRLS-FM	Hayward, WI	92.1 MHz	Move to 92.3 MHz, 6 kW.

### Changed FM Frequencies

KSSA-FM	McKinney, TX	95.3 MHz	Moved to 106.9 MHz.
KXXX	Knob Noster, MO	105.5 MHz	Moved to 105.7, 13.5 kW.

### Applications For New FM Stations

CA	Middletown	98.7 MHz	
IL	Danville	105.5 MHz	2 kW
IL	Pittsfield	89.3 MHz	42 kW
IN	Loogootee	88.7 MHz	2 kW
KY	Harold	104.9 MHz	
NM	Eunice	100.9 MHz	3 kW
NM	Grants	105.5 MHz	100 kW
OH	Richmond	104.3 MHz	
PA	West Chester	91.7 MHz	100 watts
SC	Belton	88.5 MHz	50 kW
TN	Tusculum	103.1 MHz	
WI	Goodman	91.3 MHz	422 watts

### Permits Issued For New FM Stations

AR	Eudora	101.5 MHz	3 kW
CA	Baker	101.5 MHz	4.6 kW
CA	Rio Dell	107.1 MHz	3 kW
FL	Inverness	90.1 MHz	4.5 kW
FL	Vero Beach	99.7 MHz	50 kw
HI	Hilo	95.9 MHz	50 kW
ID	Eagle	107.9 MHz	1 kW
ID	Wallace	100.7 MHz	52 kW
KS	Clearwater	98.7 MHz	6 kW
KY	Stamping Ground	99.1 MHz	3 kW
MO	Ottervill	107.7 MHz	6 kW
NC	Atlantic	107.3 MHz	6 kW
NC	Hatteras	94.3 MHz	6 kW
NC	Monroe	91.9 MHz	17.5 kW
NC	Roanoke Rapids	88.5 MHz	3 kW
NE	Norfolk	90.9 MHz	50 kW
NH	Manchester	91.7 MHz	Low power
NJ	Bridgeton	89.3 MHz	4 kW
NY	Monticello	99.7 MHz	6 kW
PA	New Philadelphia	91.5 MHz	3 kW
SC	Pawleys Island	98.5 MHz	6 kW
TN	Dyersburg	90.7 MHz	100 kW
TN	Newport	92.9 MHz	6 kW

### Cancelled; Call Letters Revoked

KKOO	Caledonia, MN	94.7 MHz
KLEI	Kailua, HI	1130 kHz
KPDN	Pampa, TX	1340 kHz
KZOX	Macon, MO	99.9 MHz
WFTJ	Inez, KY	
WKZX	Presque Isle, ME	950 kHz

An interesting insight. We appreciate Elmer Wallesen, of LaGrange Park, Illinois, for passing it along.

**Call Home:** Broadcasters like to use call letters that somehow tie in with their station's location, program format, slogan, a local industry, meaningful initials, or similar. It's become quite fashionable to change call letters when a station changes its format. To accommodate the many stations wishing to change call letters to ones they feel relate to their true

identity, or are at least easier for the announcers to say, and for the listeners to remember, there are companies that have database information on all currently available broadcast call letters. This information is constantly being updated, and it isn't at all uncommon for one station to discard a set of call letters only to have them immediately sought by another station.

Interestingly, broadcasters aren't always aware of the heritage of the call letters they assume. Not that it means a lot, but you'd think they'd be curious enough to have the whole story.

Lou Felton, of Easthampton, New York, sent in a news clipping to the effect that station WCTO/94.3 (ex-WGSM-FM) in Smithtown, New York, had changed its call letters to WMJC to go along with its new soft rock sound, and its slogan, *Magic 94.3*. The station manager was said to have mentioned that WMJC had been given up by an Indiana man who had hoped to open a station there.

The impression we got from that was that the planned Indiana station had been scrubbed. A little checking, though, revealed that what was once WMJC, in Bremen, Indiana, is still hoping to get on the air using 96.9 MHz. The difference is that now they want to be known as WYEZ, hence the availability of their previously assigned call letters. The Indiana station officially relinquished WMJC on February 10th. The recycled call letters were in use and on-the-air at the former WCTO on February 24th, 1992. That's fast!

Call letters that are often rather unappeal-

ing tongue-twisters that cause no end of headaches for announcers include those that come out sequentially from the FCC's license computer. You can see them every month in our new call letter assignment listings. This month, they include WXEAA to WXEAF, and WZJU to WZJX. *Ugh!* This is what stations get when they don't ask for a specific available call, or can't have what they asked for.

Some broadcasters are hip, or at least lucky. Their stations drew reassignments of some famous historic call letters. That preserves call letters like WENR, WCFL, WBOS, KFNF, WGAR, and many others that might otherwise have been assigned to ships. And how about WOLD, of Marion, Virginia? Their call letters were immortalized in Harry Chapin's song "W-O-L-D," about the burned out deejay who worked at a station with that call sign.

**College Station:** We got some good information from David Jessop Sage, of Aerocom Radio, Registered Monitor KMA1CW, of Boston, Mass. He let us know about WERS/88.9, Operated by Emerson College, in Boston.

WERS has 4 kW ERP, and uses an antenna about 900 ft. up on top of the Prudential tower. The station operates from 6 a.m. to 2 a.m. with plenty of folk music, jazz, and other varied programming for all tastes. David especially likes the Monday night program (8 to 11 p.m.) hosted by Athena Matsikas.

**New "FM Atlas" Edition:** The 14th Edition of the *FM Atlas* is now available. This 192-page directory is an up-to-date reference to

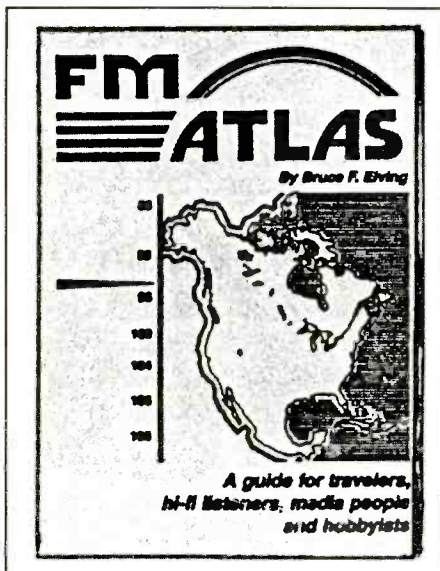

The new 14th Edition of the FM Atlas is here!

# Secret Frequencies

## The Remote Computer Scanning System™

Turn those hours of manually searching for secret frequencies over to RCSS™. The RCSS™ significantly enhances the ICOM™ R7000 receiver capabilities by providing automated PC control over receiver scanning & memory functions.



### Features

- Automatic detection and storage of active frequencies & other info while scanning.
- User specified Tuning Steps from 10-100 MHz.
- Scan Mode, Class of Service, or Type of Unit.
- Scanning resumes upon loss of carrier.
- Memory capacity: 1,000 frequencies.
- Monitor half-duplex communications.
- Mouse/Keyboard driven graphic user interface.

### SYSTEMS & SOFTWARE

4639 Timber Ridge Drive, Dumfries, VA, 22026-1059 USA  
(703) 680-3559, Fax: (703) 878-1460. RCSS™ is available for both IBM compatible & Macintosh computers.

CIRCLE 12 ON READER SERVICE CARD

### Get All The Facts On Users In Your Area

#### FCC License-Holder Information And Toll-Free Dial Access Services

- Custom Frequency Searches by Coordinates, State, County, Zip, Specific Frequencies, Category of FCC Service or Licensee Names
- ALL Frequencies • All Types of FCC Services
- You Get - Frequency, Service Type, Transmit Power, Call Sign, Site Latitude & Longitude Elevation, City, County, and State, License Expiration Date and Licensee Name & Address
- Available as a Printout or on Floppy Diskette
- Retrieve FCC License-Holder and FAA Airport Information on your PC from CET's Extensive Database using our 800# Dial Access Service

Write, Call Or Fax For More Information

#### COMMUNICATIONS ENGINEERING TECHNOLOGY INCORPORATED



1001 S. Ridgewood Avenue  
Edgewater, Florida 32132  
Phone (904) 426-0014  
Fax (904) 426-0099  
800-445-0297

C. D. U., INC.



CIRCLE 11 ON READER SERVICE CARD

## To Order Back Issues

Send \$3.50 Per Issue (Check, Money Order, Mastercard, VISA, And AMEX).

Send All Correspondence To:

**CQ Communications**  
76 North Broadway  
Hicksville, NY 11801  
Or Call  
516-681-2922

### New Shortwave Call Letters Issued

WRMI Miami, FL

### New AM Call Letters Issued

KVSF Santa Fe, NM

### New FM Call Letters Issued

KAGM Strasburg, CO  
KCLM Newport, OR  
KPNO Norfolk, NE  
KWYA Haliimaile, HI  
WDAI Pawleys Island, SC  
WIVH Christiansted, VI  
WNPC-FM Newport, TN  
WQCX Manchester, NH  
WXEA Broxton, GA  
WXEB Chateaugay, NY  
WXEC Nekoosa, WI  
WXED Morristown, NY  
WXEF Millbrook, AL  
WXTM Monticello, NY  
WZJU Wauseon, OH  
WZJV Glencoe, AL  
WZJW Norris City, IL  
WZJX Englewood, OH

### Call Letter Requests & Assignments Withdrawn

KZPP New Orleans, LA  
WCRJ Colonia Heights, TN  
WWIU Roanoke, VA

### Requested AM Call Letter Change

Now WMAX Seeks WGVU Kentwood, MI

### Changed AM Call Letters

New	Was	
KBID	KBAD	Bakersfield, CA
KBSU	KUCL	Boise, ID
KCPX	KUTR	Salt Lake City, UT
KGLW	KATY	San Luis Obispo, CA
KHNR	KORL	Honolulu, HI
KLUP	KISS	Terrill Hills, TX
KMCL	KZID	McCall, ID
KSSM	KTUN	Santa Barbara, CA
KWHI	KTTX	Brenham, TX
KYYG	KYNG	Coos Bay, OR
KZUS	KTDO	Toledo, OH
WBZT	WPBG	W. Palm Beach, FL

WDJX	WXLN	Louisville, KY
WEZI	WODZ	Memphis, TN
WHBY	WYNE	Kimberly, WI
WIQB	WNRS	Saline, MI
WJIG	WDFZ	Tullahoma, TN
WPXY	WKQG	Rochester, NY
WXOL	WLKE	Oshkosh, WI

### Requested FM Call Letter Changes

Now	Seeks	
KPAH	KHWK	Tonopah, NV
KQEM	KBRD	Seaside, OR
WHP-FM	WRVV	Harrisburg, PA
WRIP	WXCH	Versailles, IN
WTUB	WSCA	Georgetown, SC

### Changed FM Call Letters

New	Was	
KFRQ	KELT	Harlingen, TX
KGLD	KROZ	Tyler, TX
KHCR	KWVB	Potos, MO
KINE-FM	KHFX	Honolulu, HI
KMBV	KNAV	Navasota, TX
KMCL-FM	KMCL	McCall, ID
KRCI	KOUG	Avalon, CA
KRXX	KLXK	Minneapolis, MN
KSET	KAMA-FM	El Paso, TX
KTSW	KQEJ	New Braunfels, TX
KTTX	KWHI-FM	Brenham, TX
KWRV	KFTN	Sun Valley, ID
KZQQ-FM	KRPN	Roy, UT
KZUS-FM	KZUS	Toledo, OR
KZZP	KNVR	Paradise, CA
WBDK	WOMA	Algoma, WI
WBPP	WESI	Strasburg, VA
WCMM	WTIQ-FM	Gulliver, MI
WCTW	WQKZ	Catskill, NY
WDJX-FM	WDJX	Louisville, KY
WDSP	WZQF	Lecanto, FL
WFNN	WLQE	Villas, NJ
WIQB-FM	WIQB	Ann Arbor, MI
WJWV	WYHD	Ft. Gaines, GA
WKDW-FM	WSGM	Staunton, VA
WKLK-FM	KOUV	Cloquet, MN
WLET-FM	WZLI	Toccoa, GA
WMJC	WCTO	Smithtown, NY
WODZ-FM	WFGI	Germantown, TN
WRTM-FM	WYHF	Ripley, TN
WVRI	WSTF	Cocoa Beach, FL
WYEZ	WMJC	Bremen, IN
WYZM	WIMN	Waukegan, WI

the FM broadcasters of the USA, Canada, and Mexico. The new edition has 94 pages of maps to help pinpoint some 7,250 FM stations. The station directory sections are arranged by geography and by frequency. Information provided includes program formats, stereo and tech data, "non-ID's," multi-city ID's, and stations carrying "hidden" programming on their subcarriers. FM translators and boosters are covered in a special section. There are also a number of worthwhile editorial features on various topics such as improving your FM reception, etc.

This new edition is \$10.95, plus \$3.50 for UPS shipping (sent by First Class mail to military addresses, AK, HI, PR, GU, VI, and Canada). It may be obtained by mail from CRB Research Books, Inc., P.O. Box 56, Commack, NY 11725. Residents of NY State please add \$1.15 tax.

*Freedom of Speech Issue:* FCC broadcast regulations allow for programming aired in the evening hours to be more adult-oriented than those broadcast during the day. Even within those rules, it's still the FCC's call as to what they'll consider acceptable adult-oriented programming and what they won't accept. For daylight hours, though, they have a short fuse when programming goes out that they feel is beyond their standards for acceptable language.

At 5:10 p.m. on March 30, 1987, and between 2:30 and 4:30 p.m. on August 19, 1987, the FCC decided that the programming of Chicago's WLUP/1000 (50 kW) was "indecent." The FCC declared that it was a

violation of Section 1464 of the Communications Act which prohibits utterances of "any obscene, indecent or profane language by means of radio communication." Subsequently, the FCC imposed a monetary forfeiture of \$6,000 on WLUP.

WLUP didn't pay this, and denied liability. A follow-up reminder from the FCC about the payment did not bring forth the desired payment, and the FCC has now decided that the station's desire is to settle the matter in court.

The US Supreme Court agrees that the FCC can impose limited hours when "indecent" programming may be broadcast. The problem has long been for anybody to come up with a clear determination of indecency, what with uneven and constantly changing community acceptance of such things. Furthermore, it's difficult to be too specific since a certain word used by a deejay or in a joke would be considered indecent, but might well be found acceptable when used in readings from the works of classic authors like James Joyce, Shakespeare, and others whose language was uninhibited.

The FCC is at its best when establishing tech standards, licensing broadcasters and sorting out problems of interference. The agency, as representative of the federal government, begins to get in over its head when it seeks to regulate free speech and to set community standards for "acceptable" language. People (including children) aren't likely to hear anything via a broadcaster that they haven't already heard elsewhere. Tuning dials and on/off switches are put on radios for people who don't like what stations have to say. Audiences don't want these decisions made for them by the government.

We wish WLUP luck in their efforts to determine their own programming. Broadcasting is a tough enough business these days, as it is, without it being made all the more difficult.

Meanwhile, KFMH, of Muscatine, Iowa, and WWZZ, of Karns, Tenn., were recently sent FCC letters asking for more information relating to the possibilities that they may have violated the agency's indecency regulations. Reportedly, the FCC is interested in learning more about a allegedly told on KFMH, and a station promo used on WWZZ.

*Bring Back The "Good Guys":* Long ago, New York City's WMCA/570 was a rock station known far and wide as the home of the "WMCA Good Guys." That was many years, many formats, and several owners ago. More recently, WMCA has run a mostly religious-oriented format. That didn't stop the station from getting hit with an FCC notice of apparent liability for \$12,500.

The forfeiture stems from a complaint alleging that a weekly program, *Healthline*, was a paid-for program but not identified as such. In response to FCC inquiries, WMCA stated that the Dr. Stuart Berger purchases the entire block of time from the station for this program, using it to discuss health issues and promote his medical practice, also selling time to sponsors promoting products.

The FCC decided that the content of the program alone does not make it clear that *Healthline* is paid for by Dr. Berger. Although WMCA has taken steps to correct the situation, the FCC penalty was for past violations.

*Opening Up The Market:* FCC regs long limited single licensee ownership of a maximum of a dozen AM and a dozen FM stations, with no more than one of each in any

given market. The FCC has now changed this to permit 30 AM and 30 FM stations to be owned, with multiple stations in a single market.

We will be at this spot on the dial next month. Hope you will, too. Let us hear from you with news clippings, photos, bumper stickers, recent AM/FM QSL's, format changes, station info, and what-have-you.

## THE BURIED "HERO" OF DESERT STORM... INTRODUCING THE ELPA-3/65 LOW PROFILE ANTENNA.

Eyring's military version of this ground cooperative antenna was successfully used behind enemy lines by U.S. long range surveillance teams. Desert deployment allowed the antenna to be buried, thus protecting the integrity of the team's positions. Its spectacular performance made it an invisible hero of insurgent operations. Commercial version NOW AVAILABLE for amateur use.

- No masts required. Lays on ground in a variety of configurations.
- Short and long hop. Bi-directional, omni, or uni-directional. True NVIS.
- Ground effect lowers receive noise floor.
- Broadband - no tuner or length adjustment required.
- SWR less than 2:1 typical, 3-65 MHz into 50-ohm feed.
- Use in restricted covenants area - . . . neighbors won't know
- Over 8,000 test data points.
- Compatible with frequency hopping and spread-spectrum HF/VHF systems.
- Perfect for emergency communication - quick deployment - 5 to 10 minutes typical
- Deploy in dark and near helicopter landing zone
- U.S. Patents: 4,809,010 5,829,310 4,743,917 4,839,661 4,825,224 4,750,001.
- Foreign Patents Pending

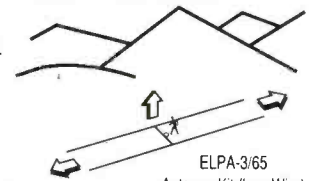

ELPA-3/65  
Antenna Kit (less Wire)  
Includes two EFU's  
(element feed unit) and  
one splitter

**The ELPA-3/65 INTRODUCTORY PRICE \$199.00**

Add \$6.00 for shipping and handling. Utah orders require sales tax. Visa/MC accepted.

Regular Price: 239.00

Call (801) 224-1800 or write for information brochure. FAX (801) 224-7526  
IVIE TECHNOLOGIES, 1366 W. Center St., Orem, UT 84057

Made in the USA

CIRCLE 6 ON READER SERVICE CARD

### SE SIGNAL ENGINEERING'S High Performance CB Antennas

**SUPERHAWK**  
\$114.95

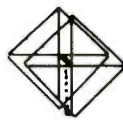

**Goldenrod  
45 Mobile  
Antenna**



**SPYDER A**  
\$35.95

**WHITE-LIGHTNING**  
\$199.95

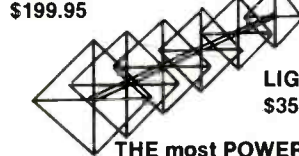

**LIGHTNING 6**  
\$359.95

**THE most POWERFUL  
CB base in the world today!**

All SE PATENTED rotary beams are true quads and OUTPERFORM their counter parts (quad/yagi types). SE's patented SFS matching system makes SE QUADS the most technologically advanced antennas in the world today.

If your dealer doesn't have SIGNAL ENGINEERING, write or call for full specs. DEALER inquiries invited.

**SIGNAL ENGINEERING**

2624 Fayette Drive, Mountain View, CA 94040  
(415) 948-3833

### BOOK II HOW TO GET ANYTHING ON ANYBODY

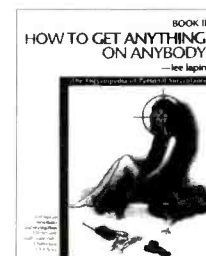

**ALL NEW LEE LAPIN!**

**Best Bugs On A Budget** to super secret CIA fine wire kits. How the FBI sees thru walls to low cost starlight scopes. Electronic and mechanical tailing tricks, surveillance photography, intelligence kits. **Cutting edge** audio/video surveillance, HOW TO crack computers, bypass passwords, obtain unlisted phone numbers, intercept cellular calls, pagers, and faxes, trace and track anyone, surveillance proof any room, tap any phone, and more! **WHEW!** "Really scary stuff." Charles Jaco CNN. \$38.50 postpaid.

**ORDER TODAY!**

ISECO, 2228 El Camino Real, #349-23,  
San Mateo, CA 94403. 415-513-5549.

CIRCLE 4 ON READER SERVICE CARD

# NEW PRODUCTS

## REVIEW OF NEW AND INTERESTING PRODUCTS

### Multiband, Multimission VHF/UHF Radio

New from Harris RF Communications Group is a multiband VHF/UHF radio transceiver designed to meet the multimission, multiwaveform requirements of modern international defense forces.

The AN/PRC-117D(E), which was introduced by Harris specifically for export markets, provides multiple frequency bands in one compact lightweight manpack radio set. The AN/PRC-117D(E) operates in VHF-FM, VHF-FM/AM and UHF-FM/AM frequency bands and provides for line-of-sight (LOS) operation in all bands, giving complete mission flexibility for ground-to-air, ship-to-ship, ship-to-shore and ground-to-ground communications.

The AN/PRC-117D(E) is interoperable with most tactical radios, including fixed frequency VHF and UHF systems. Waveforms include AM and FM modulation, and Harris' proprietary ECCM frequency hopping. ECCM capability is available in all bands in all line-of-sight modes, and is interoperable with fielded AN/PRC-117A and AN/VRC-94A(V) series radios.



When used with the built-in RF-3995 digital encryption option, the AN/PRC-117D(E) provides advanced communications security in the voice and data modes. The RF-3995 uses a proprietary pseudorandom key-generator algorithm with up to  $10^{52}$  possible combinations.

The unique combination of multiple frequency bands and waveforms available in the AN/PRC-117D(E) effectively reduces the number of radios needed to provide the same communications capability.

The AN/PRC-117D(E) is available in manpack and vehicular version. The complete manpack radio set weighs only 15.2 lbs (6.8 kg), including battery, antenna and handset. The vehicular version is available with either 10 or 50 watt output.

For more information, contact Harris Corporation, 1680 University Ave., Rochester, NY 14610.

### Broadcast Interference Filters

Northwest Communications Laboratories has developed Broadcast Band Interference Filters for the monitoring enthusiast who is plagued with the hash, splatter, and noise typically present when trying to monitor the spectrum above and below the AM broadcast band. This interference can be particularly troublesome if your station is in close proximity to the AM broadcast transmitter. In some cases, Very Low or High Frequency reception is impossible.



The Model 100 and 200 allow frequencies below and above the AM broadcast band to pass freely while blocking broadcast band energy from reaching the receiver. If these large signals are allowed to reach the receiver input, they would overload the preamplifier and mixer stages. This causes the problems typically referred to as Broadcast Band Interference (BCI). The Model 100 allows clean reception below the AM broadcast band while the Model 200 is used for reception above.

These filters employ Chebychev design circuits that provide 40 dB of broadcast band attenuation. They are compatible with all tuners, preamplifiers, and lightning arrestors. Their input and output impedance is 50 ohms, allowing for direct connection to most communication receivers with a shielded jumper cable (not supplied).

Their construction gives the user great flexibility in choosing a mounting location that best suits the station. The case is cast aluminum with a weather sealed interlocking cover to eliminate stray RF energy or moisture. The circuitry is encapsulated for immunity from either shock or vibration, and provides additional moisture protection. In addition, NCL offers a variety of mounting brackets, connector styles and shielded jumpers to make installation even easier.

If you are not lucky enough to live in an area free of AM broadcast transmitters, or just want to have an extra measure of receiver selectivity, the Model 100/200 family of Broadcast Interference Filters is for you.

For info contact: Northwest Communications Laboratories, 813 SW Highland, Suite C-310, Redmond, OR 97756.

### Attenuator Box For Transmitter Hunters

Electron Processing announced a necessary tool for everyone involved in the fun of transmitter hunting. Reducing the signal received to a meterable level is easy with our SGR-1 attenuator box. Accurate signal comparisons of strong signals and a simple tool to aid in receiver alignment are two of many uses for this handy device.

The SGR-1 is a three section 50 ohm attenuator box that allows you to switch in or out up to 50 dB of attenuation in 10 dB increments. Easy operation via three toggle switches. Ruggedly constructed and compact, the SGR-1 is ideal for hunting down interference sources. Connection is easy via the two female BNC connectors provided.

The SGR-1 is priced at \$50, plus shipping for additional information, contact Electron Processing, Inc., at PO Box 68, Cedar, MI 49621 or circle 101 on our Readers' Service.



### Hi-Tech British Radios Now Available

Lowe receivers are now available in the U.S. and Canada. High quality design, construction and performance are the trademarks of these British radios. HF150 is the latest Hi-tech receiver, covering 30 kHz to 30 MHz, AM, SSB, and Synchro detection. It is equipped with 2.5 and 7 kHz filters, 60 memories, and a large LCD readout. It accepts three antennas, balanced wire, whip and 50-ohm. Optional keypad entry, 10-15 VDC power 150-250MA, opt 8 NiCad or ALK AA batteries, and opt. AC adapter. All metal alloy case, only 7.3" x 3.2" x 6.3" and weighs less than three pounds.

This dynamite package performs with the big boys yet has a small price tag—under \$700. HF225 and HF235 are also available.

For more details call/fax or write EEB, (800) 368-3270, FAX (703) 938-6911, 323 Mill Street, Vienna, VA 22180.

# PIRATES DEN

BY EDWARD TEACH

## FOCUS ON FREE RADIO BROADCASTING



**T**he deck's awash in reports again so let's get right at it, again giving emphasis to the newer stations.

**WEFR - Worldwide Free Earth Radio** was noted by Shawn Miller, Georgia, on 7412 from 0341 with hard rock and claiming to be in the Yucatan Peninsula. QSL via Blue Ridge Summit.

Paul Ecke in Louisiana found **The Voice of Anarchy** with "Leonard Longwire" on 74518 to 0208 close, giving a Chicago location. Skip Harwood, California had them at 0135 on 7419. Mark Mayhew had them on 7415 at 0145 with "Larry Longwire". Greg Martin, Michigan, found them with "Woodstock" excerpts at 0758. Mac Woodman, Georgia had them on 7415 at 0015.

**DC Radio** showed for Janet Whitney, Virginia, on 7416LSB at 1800 with the "Al Sikes Show" and an interview with a claimed former CIA agent. Pat Murphy, Virginia had them at 1925, requesting reports to the ACE bulletin

William T. Hassig, Illinois, had **RFM** on 15050 at 2207 in French and English, with the POB 109, Blue Ridge Summit address.

**WFRC International**, heard on 7415 at 0733 by Anthony Doriguzzi, Pennsylvania, with hits, fake commercials and mentions that it was a New Year's Eve, 1989, so perhaps a rebroadcast?

**RCVN** on 7416 at 0328 giving an address of: RCVN, Attn: QSL Manager, POB 17534, Atlanta, GA 30316. Carrying the "Good Time Radio Hour" of country western and

rock, says Walter Talbot in Pennsylvania. Mac Woodman ID'd this as RBCN (Bob's Communications Net). Harwood had this at 0330 with Radio Bob and the Voice of Shakerag, later stepped on by three other operators.

Voice of the Night, noted by Woodman at 0250 on 7415 with humor and classic rock, Slinky Toy theme song, Pittsburgh address. Murphy heard this on to 0400 close with commentary on the state of pirate radio, old movie themes. Woodman found this at 0015.

Harwood had **Rastifarian Radio** on 7419.5LSB at 0500, reggae music, address of POB 25302, Pittsburgh, 15242. Robert Ross, Ontario had them on 7417.5LSB at 0138, announcing 7416 and "the only pirate station that plays reggae music."

**EXPR - Experimental Propagation Radio**, on 7416 at 0416, reports Talbot who heard "John" mention 100000 microwatts of power. Harwood had them at 0420.

**WQRV, the Rock Radio Network**, with Dr. John Thomas, humorous commercials, classic rock. Off at 0437 says Woodman.

**KCMR - Magic Carpet Radio**, heard by Harwood at 0310 on 7416 with talk show, "Magic Mike, "Wanda" and new YL child as DJ. Skip had them another time on 7420 at 0255.

Greg Martin heard **Radio Gloria International** on 7415 via "a special North American relay station" at 2023. Address given as 23 South Beechwood, Edinburgh,

Scotland, EH125 YR.

Harwood heard **WJFK** on 7415 at 0130 with loop tape of "Loony Tunes" theme.

Another Harwood log was **KQRPP** at 0135 on 7416, stepping on WJFK a few times.

**Q-102** noted by Murphy on 7420 at 0535 with lots of transmitter problems, commercial spoofs, no QSL info.

Murphy also heard **WRPD** on 7415 at 2140 with mostly heavy metal rock, ID "This is WRPD, our initial broadcast" and reports to Blue Ridge Summit. Pat says the announcer had a "laid back whisper" style.

Another Murphy log was **WCYC** at 0027 on 7415, claiming a Kentucky location and giving the Blue Ridge address and offering a special QSL for detailed reports.

Harwood had **KRPP** 7415 at 0235 with talk, **Radio Underground** on 7415 at 0400 with a humor program and **Action Radio** on 7416 with rock songs at 0315.

**East Coast Beer Drinker** was logged by Murphy on 7415.95 at 0402 - "This is the East Coast Beer Drinker" and "Emergency Beer Drinking System test", relay of Radio Gemini. Harwood had this at 0410.

Other stations reported this time: KXKVI - Interplanetary Radio, 7415 at 0335 by Harwood; WLIS, 7415 to 2336 by Murphy; WQRV-7415 to 0513 (Murphy); WSKY-7415 to 0308 (Murphy) and 0230 (Woodman). CBOR-7415 at 0145. (Woodman). There were many reports of Radio USA, including those from new reporters Gary Heindnen, Minnesota; Chris Thompson, Connecticut; and Shawn Miller, Georgia.

**POINT OF ORDER** - I am never sure when "LSB" or "USB" are included in your reports just whether you mean the broadcast was in that mode or you used that receiver setting to improve reception. "T" wud help if you could specify.

Out of space. Thanks for your reports - keep 'em coming! See you next month! ■



This is a photo (center) of the famous Radio Caroline ship, the *Ross Revenge*, now in the port of Dover, England. The last broadcast from the ship was in the fall of 1990. It remained anchored in international waters until late November last year when it broke free and was towed to Dover where it faces an uncertain future. (Thanks Mike Smith, Cambridge, England).

## 27 MHz COMMUNICATIONS ACTIVITIES

**W**e always like Cobra's products, not only because they're excellent, but because Cobra goes back a very long way in CB radio and has continued to produce for the field long after many other manufacturers quit CB. Cobra has supported CB, and that's given them a special place with us, and with many operators.

One of the Cobra rigs we particularly like is their Model 25LTD Classic. Here's a good looking rig with an MSRP of about \$160. Its got that distinctive Cobra look, but the important thing is that it's small while having big performance.

If you prefer an actual meter on your rig's front panel to LED's for your S/RF-meter, this rig has one. It has separately switchable ANL and NB circuits, plus a large channel switch knob. There's an RF gain control, and a mike gain control, a dimmer switch, and big green LED channel read-out.

The unit is approximately 6 inches wide, 2 inches high, and 8 inches deep. It weighs less than 4 lbs.

Ask about it at any of Cobra's many dealers.

### Oldies

In the history of CB radio, there have been a mere handful of companies that became legends because of their exotic, high-priced, high-quality equipment. Browning was one of them, and Tram Electronics was certainly also on every list. This was a small company in Winnisquam, New Hampshire. Run by Ron O'Callahan, it came on the CB scene about 1963 and was active until at least the late 1970's. It produced beautiful equipment.

One of Tram's first units was the TR-70, which came out in 1963. This mobile rig had six transmit and receive channels, plus all-channel tunable receive. The dual conversion receiver had a switchable series gated NL. The transmitter had a pi-network, plus a built-in low pass TVI filter in the days when they weren't necessary. The circuitry equaled 17 tube performance, plus a transistorized 6 and 12 VDC power supply. It sold for \$225, which was a lot more money 30 years ago than it is today.

Trams have become quite collectible. One of our readers, Lynwood Geddings, of South Carolina, has been lucky enough to assemble representative samples of the Tram 2, Tram TR-2A, Tram 4, Tram TR-27D, Tram D201, Tram D-201A, and Tram D-300. Lynwood is still looking for a Tram TR-27E. If anybody has one for sale, contact Lynwood at RR 7, Box 315, Sumter, SC 28150.

Dr. DX, Unit 198, also known as Dave (location unknown), wrote to ask why we



Pop an eyeball on Cobra's Model 25LTD Classic. We have always appreciated Cobra's loyalty to the CB'er.



Tram was one of the few CB manufacturers ever to achieve truly legendary status. This is their Model TR-70, from 1963.

bother to devote any space here to "oid equipment." Otherwise, he likes the column a lot.

The reasons why are simple. Readers asked for this feature, and it attracts a considerable amount of favorable mail. Who was it that once observed that without knowing where you've been, you can't know where you're heading?

### From The Mail Sack

Another letter has arrived from *Black Sheep*. We mentioned him a few issues back. He's the fellow who told us that several of the legal bordellos in Nevada are CB equipped for communicating with passing motorists, especially truckers.

This time, *Black Sheep* snapped a photo

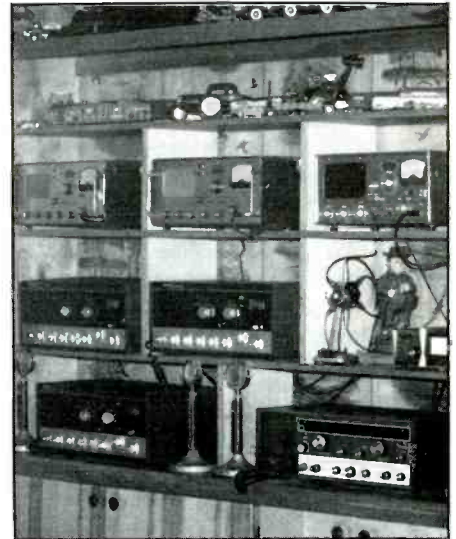

Lynwood Geddings' beautiful collection. The set at the upper right is a Hallicrafters S-40A receiver, but everything else is pure Tram, and just great.

of *The Cottontail Ranch*, at Lida Junction, Nevada. This is in the middle of nowhere, at the junction of US 95 and Nevada 266, which is not far from the California border.

In the photo, it looks to be a *Big Stick* antenna mounted on a few sections of TV mast anchored to the front of the building. We thought of a couple of clever CB handles they might use, but won't mention them here.

A note from Jerry M. Stuart, Box 2652, Lawton OK 73502, questions the warranty policy of Midland International. He returned his set to the company because it had a circuit problem. They sent the set back to him without fixing it, advising that any scratches on the top or the bottom of the case void the warranty. He didn't ask them to fix the scratch on the case, just to make the set work again.

We have never heard of this problem before, Jerry, and we can't understand why they wouldn't repair the unit solely because of a scratch on the case. Perhaps other readers can come up with some expertise on this; there must be more to it than the information we have been given.

Thanks came this way from Paul S. Ryan, Marlborough, Mass., who liked the home-brewed CB apartment antenna we showed here in March. His landlord doesn't allow CB antennas, and that had Paul off the air for four years. Our antenna saved the day!

### Day Of The Computer

From a hidden location in Massachusetts,





A photo QSL of the shack at Unit 876, operated by Dan MacNeil, North Vancouver, British Columbia, Canada.



Izzat Tom Cruise? Nah, it's Dave, "Dr. DX." Watch out Dave, the class monitor will see that odd looking box on your shelf and we'll get another letter telling us to watch our step.

a letter arrived via E-mail and FAX from Michael C. Tiernan. It had no less than six E-mail computer return addresses, but not one postal reply address was provided with the name of a place where people live. Mr. Tiernan observed that in the March issue we ran a CB QSL card showing a DX contact. He guesses that Hungary might be more than 150 miles away. Therefore, he noted, unless the FCC has changed its CB "laws," he wished to put us on notice that we were therefore promoting violation of those "laws." He suggested that we "watch the way" we write such things up.

We do watch the way we write such things up. That's because we type with only two fingers and need to continually look at the keyboard while we write. However, we would like to remind Mr. Tiernan that we did not invent DX CB operation, and it was the



"Black Sheep" tells us this is the Cotton Tail Ranch, in Nevada. That's a CB antenna to the right of the telephone pole.

# The Best\* Just Got Better!

The Eavesdroppers™ now includes our new Zap Trapper™ Electronic Gas Tube Lightning Arrestors. Receive-only design shunts damaging transients to ground at only 1/7th the voltage buildup of the available 200 watt transmit-type arrestors, providing maximum solid state receiver protection.

Protect your investment - combine an excellent shortwave receiving antenna with the best receiver protection money can buy.



- Completely assembled and ready to use
- Only 42' overall length
- 8 trap circuits permit reception on all shortwave bands, 11-90 meters
- All connections soldered and enclosed in ultrasonically-welded, hermetically-sealed trap covers
- Includes 50' of 450 lb. test nylon rope

**Model T** includes 100' twinlead feedline

**Model C** includes weatherproofed center connector for your coax & coax sealant

- Either model \$79.95
- UPS for lower 48 states \$4.00
- COD add \$3.00, IL add 7% sales tax
- Foreign shipping quoted

\*"The best...built like an antenna should be." -Larry Magne in *World Radio TV Handbook*

"Our best seller." -EEB in their recent ads and catalogs

"Now in use in 45 countries." -Giffler Shortwave in 1983

## Antenna Supermarket

P.O. Box 563 Palatine, IL 60078 Tel (708) 359-7092 Fax (708) 359-8161

At your dealer or direct ▪ Visa & Mastercard accepted

FCC's sole decision to locate the CB service in the DX-rich 27 MHz band. DX'ing on CB has been heavily done without stop since late 1950's, though it has always been forbidden by FCC regulations. Furthermore, FCC regulations are not "laws," as Mr. Tiernan claimed.

We don't promote, endorse, encourage, or instruct in the practice of CB DX'ing. Even though we are not an arm of the FCC, we nevertheless mention what their regulations are, no matter how unrealistic and ineffective those regulations might be.

We do have our limits. We don't enforce the FCC's CB regulations, nor bash our readers over the head with them, nor lay a guilt trip on any readers who elect to deal with

them in their own way. That's between each individual reader, his or her own conscience, and the FCC.

Is there any logic in the idea that by our ignoring certain unauthorized practices, we can make them cease to exist? Or, on the other hand, when we mention the practices, we are promoting them? Our readers want to know what's happening on the band. As the only national CB news medium, we feel it is easily within the scope of our coverage to mention DX in our coverage as appropriate. When newspapers and broadcast media either lose the right or voluntarily stop mentioning unauthorized practices, for sure, we'll reconsider our own position.

In the mean time, we are thankful for at last

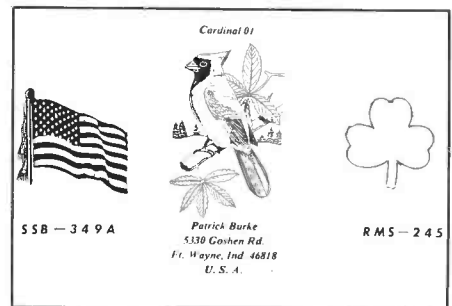

New QSL from Pat Burke, SSB Network member SSB-349A, and RMS-245, of Ft. Wayne, Ind. Good to hear that you're feeling better after the surgery, Pat!

having a class monitor. Just what CB needed.

## Base Station Antenna Brainstorm

Setting up a temporary or emergency base station antenna usually involves either a lot of work, or else making do with a jury rigged Mickey Mouse antenna that loads up only slightly better than a piece of damp string. Here's an idea for getting you on the air with a minimum of time and trouble and very little outlay of greenstamps.

That makes it just the thing for vacationers, hunters, campers, or even commercial users at temporary sites. It's good for command posts, or for CB'ers who lost their base station antenna due to a storm. It's even a possibility for CB'ers who have just moved into new digs and haven't gotten around to putting up that new antenna. In other words, it's a wonderful cure-all for a wide range of base station antenna problems. Yet, it is very basic.

The point of the idea is to set up your base station and then use the antenna on your regular mobile installation for your base station. Why not? You spent time and money on the mobile antenna installation, and it probably does a good job. It's a professionally built and designed antenna, even having its own ground plane (the vehicle itself). So, it's got the makings of a base station antenna, and you can take it with you everywhere you go. Mostly it just sits there doing nothing while you make do with some temporary or less-than-fully-effective contraption.

If you have a rear mounted mobile vehicle antenna, open the trunk of your car. You then take a pair of wire cutters and snip the coaxial cable about 6 inches from the connection with the antenna. On the piece of cable that goes to the antenna, solder an SO-239 coaxial receptacle.

On the remaining piece of cable, the one that runs to the mobile CB in your vehicle, connect a PL-259 coaxial plug. When the mobile rig is to be operated, this PL-259 must be connected to the SO-239 receptacle on the antenna lead.

All that is left to do is to secure a length of coaxial cable of sufficient length to reach the vehicle from the location of your base station rig, and then attach a PL-259 to each end of that cable. You may wish to simply purchase a pre-cut length of coaxial cable with the PL-259 connectors already installed. Radio Shack offers 50 ft. of RG-58 with connectors (catalog number 278-971) for \$13.99, also 50 ft. of RG-8 with connectors (catalog number 278-980) for \$32.99.

When using the mobile antenna for your base operations, park the vehicle as far from the transceiver as the cable length and other considerations will allow. Then, open the vehicle's trunk and connect one end of the coaxial cable to the mobile whip, the other to your CB rig. It may be necessary to use some duct tape in a couple of places to bear the weight of the coaxial cable so that this burden isn't borne by the connectors, the CB radio, or the coaxial lead from the mobile antenna.

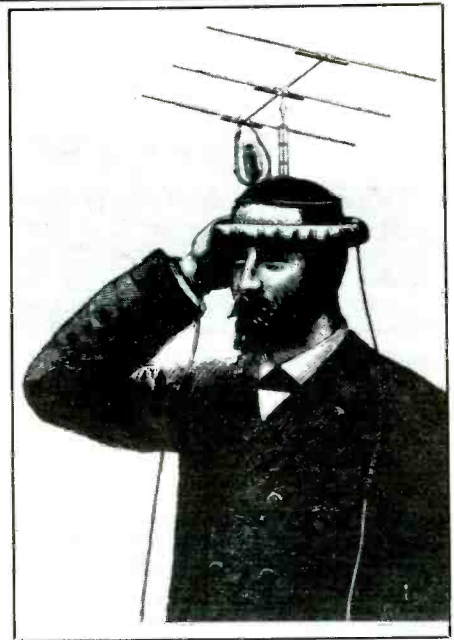

*We are thankful for having a class monitor who just became aware of what's happening on the band. With the FCC so busy, and the media so indifferent, it's just what CB needs!*

## Computer Aided Scanning

*a new dimension in communications from Datametrics*



Now Radio Shack PRO 2006 owners for the first time have access to the exciting world of Computer Aided Scanning with the highly acclaimed Datametrics Communications Manager system. Computer Aided Scanning is as significant as the digital scanner was five years ago and is changing the way people think about radio communications.

- The Datametrics Communications Manager provides computer control over the Radio Shack PRO2006 receiver.
- Comprehensive manual includes step by step instructions, screen displays, and reference information.
- Powerful menu driven software includes full monitoring display, digital spectrum analyzer and system editor.
- Extends receiver capabilities including autolog recording facilities, 1000 channel capacity per file, and much more.
- Uses innovative Machine State Virtualizer technology (patent pending) hardware interface by Datametrics.
- Simple 4 step installation - no soldering or modification to normal receiver operations.

## Datametrics, Inc

- Computer Aided Scanning system \$ 349
- PRO2006 receiver w/interface installed and CAS system \$ 749
- Manual and demo disk \$15
- Requires Radio Shack PRO 2006 receiver and IBM PC with 360K memory (640K for full channel capacity) and parallel (printer) port.

Send check or money order to Datametrics, Inc., 2575 South Bayshore Dr., Suite 8A, Coconut Grove, FL 33133. 30 day return privileges apply.

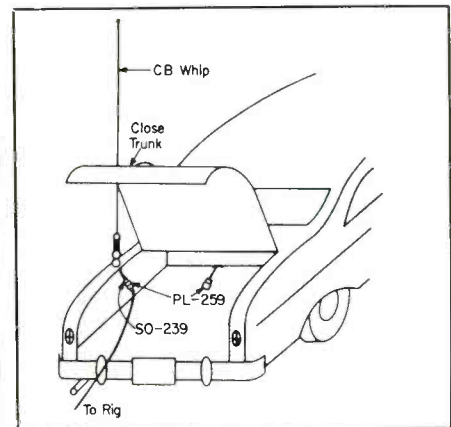

Rear mount for hooking up a base station to the mobile unit's antenna.

It's going to be difficult, if not impossible, to shut the vehicle's trunk with the coaxial cable in place. An open trunk lid isn't good while you're operating, though. Get some sort of weight on the lid to (or rope) to hold it closed as much as possible.

Mobile mount CB whip? OK! Put it on the vehicle's roof and connect it to your 50 ft. length of coaxial through a type PL-258 coaxial coupler (Radio Shack 278-192).

Just one last thought. Don't forget to disconnect your base station from your mobile antenna before you use the vehicle. A CB rig makes a rather large hole in the window when tugged hard by a moving vehicle.

Hey, come back on channel in August. Send in your QSL or station photo, your comments and questions, and we'll be standing on the side till then.

# CLANDESTINE COMMUNIQUE

## WHAT'S NEW WITH THE CLANDESTINES

**R**adio Free Bougainville, which had just gone on the air in support of Bougainville's independence from Papua New Guinea, was off the air soon after it began. Authorities apparently raided and closed the station and are prosecuting the operator, Sam Voron, a 38 year old Australian from Sydney, who holds ham call VK2BVS. The station, operating from the small town of Arawa was encouraged and supported by the International Amateur Radio Network (operated from Maine by K1MAN). IARN says the station will return to the air.

Another clandestine station which was closed down has returned to the air. La Voz de la Federacion Mundial de Expresos a Politico de Cubanos operated on 7080 for a few brief and sporadic broadcasts last fall. The station was traced to a site in Tampa, Florida and closed down by the FCC. But it has popped up again, this time using 7417, running a so far very limited schedule which seems to be just Friday evenings (Saturdays UTC) at 0130 to 0145. The broadcast consists of Spanish language anti-Castro talks and strings of ID announcements. So far there's no known address for this one.

The Voice of the Democratic Alliance of Burma continues to be scheduled at the useless (for North Americans) time of 0130-0330 to 7137.5. The other Burmese clandestine offers more chance but we don't know of any logs for this one, either. Check for the Voice of the People of WA State on 5110 at 1300-1330.

The Voice of China, a freedom-type program being aired on shortwave via the Broadcasting Corporation of China (Taiwan) is announcing an address in the United States: P.O. Box 11696, Berkeley, CA 94701.

The Colombian clandestine station, Radio Patria Libre, is now said to have an "international service". But it airs only two times a month! It's scheduled at 2030-2040 and 0130-0150 on the first and 15th of the month on 14951.

Radio Free Croatia broadcasts on WHRI with a non-QSL letter which gives times and frequencies for the WHRI broadcasts as Mondays, Wednesdays and Fridays at 0100-0130 on 7315 and 9495, repeated at 0330-0400 on the same days. The letter says you can direct your reports to Radio Free Croatia, in care of WHRI, P.O. Box 12, South Bend, IN 46624. The letter also provides the current schedule for Croatian Radio Zagreb, which WHRI also relays Monday through Friday at 0000-0100 and Saturdays 0100-0200, repeated each day at 0400-0500 on the two frequencies mentioned above. Thanks to R.C. Watts in Kentucky for sending a copy of that letter.

The half-pirate, half clandestine station



**RESISTÊNCIA NACIONAL MOÇAMBICANA  
RENAMO**

*Renamo is back on the air with its Voz de Renamo station (The Voice of the Mozambique National Resistance).*

Voice of Tomorrow has been sending out QSL's again, apparently still via the P.O. Box 314, Clackamas, CO 97015 address. It might be wise to address your letter only to the P.O. Box and not mention Voice of Tomorrow on the envelope. This station makes only three or four appearances per year. When it shows it has always been on 6240 or 7410.

The Voice of the Mozambique Resistance station (Voz da Renamo) has returned to shortwave and is reportedly using 9990 at 1500 to 1600 and 0500-0530. It still has not been reported by any monitors in North America. Vito Echevarria, who keeps a close eye on the Mozambique situation says he hasn't seen any info on the station in his various database sources. He suspects it may be broadcasting from South Africa, or possibly Kenya which, he notes, has been providing sanctuary and training for Renamo for the past couple of years. He notes that the original station, Voice of the Mozambique National Resistance was, according to a former member of the South African military,

broadcasting from the Hillbrow Tower in Johannesburg.

Incidentally, the Voice of Taiwan, another clandestine which appeared using 9990 the same month as did Renamo has not been heard lately either.

The Voice of Palestine program, carried by Radio Algiers, has doubled in length, and now airs from 1700 to 1900 on 17745. The program is also carried via Radio Damascus, Syria, on 12085 and 15095 at 1630 to 1730, although this one is aired only irregularly.

Excellent reception of the Voice of Free Sahara, via Algeria, was being noted as this was being written. Check 15215 between 2200-2300. Programming is in Spanish.

That will cover things for this month. Remember that we welcome your clandestine station loggings, QSL news, address information, news clippings and so on. It's helpful if you put your clandestine information on a separate sheet from reports for the *Listening Post* column. Thanks.

Until next month, good hunting! ■

## Subscribe Now and Save

# 12 Issues—Only \$19.95

**FREE  
SAMPLE  
COPY!**



**ANTIQUE RADIO CLASSIFIED**

*Antique Radio's Largest-Circulation  
Monthly Magazine*

Articles - Classifieds - Ads for Parts & Services  
Also: Early TV, Ham Equip., Books,  
Telegraph, 40's & 50's Radios & more...

*Free 20-word ad each month. Don't miss out!*

1-Year: \$27 (\$40 by 1st Class)  
6-Month Trial - \$15. Foreign - Write.

A.R.C., P.O. Box 802-T7, Carlisle, MA 01741

**TOUCH-TONE DECODER/DISPLAY  
& ASCII CONVERTER BOARD**

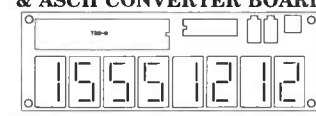

Model TDD-8 decodes and displays all 16 DTMF digits and provides an ASCII serial output. Digits are displayed on eight LED's. 32 character memory can be scrolled. It will accept almost any audio source, such as a scanner, tape recorder, telephone answering machine, etc. Serial output can be connected to your computer. IBM compatible software included for displaying, storing and/or printing time, date and number for automatic logging.

<b>TDD-8 DTMF DECODER/DISPLAY/ASCII</b>	<b>\$99</b>
<b>CAB-1 AUDIO &amp; COMPUTER CABLES</b>	<b>\$20</b>
<b>PS-12 110VAC TO 12VDC POWER PACK</b>	<b>\$10</b>
<b>add \$5 S/H - VISA/MC ACCEPTED</b>	

---

**MoTron Electronics**      **TEL: 1-800-338-9058**  
 310 Garfield St.#4      (503)-687-2118  
 Eugene, OR 97402      **FAX: (503)-687-2492**

(Touch-Tone is a trademark of AT&T)

### Tone Call

Two-way radio handheld transceivers are now small enough to work as pagers. Instead of carrying both your portable pack set, as well as a pager, a first responder might now have an all-in-one handheld transceiver.

Many rescue squads and emergency response teams still use the tried and proven two-tone selective signaling system. Two-tone calls normally take about 5 seconds to send, and as soon as your silenced receiver picks up your specific tone combination, it opens squelch and allows you to listen to the ensuing call. Base stations might also use the incoming tones to activate an alarm, flash a light, or even raise the automatic doors to your emergency vehicle garage.

While two-tone alerting and paging is still in use throughout the United States, many emergency response organizations are switching over to DTMF paging. "DTMF" stands for dual tone multi-frequency, and is also known by its trademark name, "Touch Tone®". These are the exact tones you hear when you push the buttons on your home phone. Each button represents a pair of simultaneous tones, so the words "dual tone" mean two tones at the same time.

DTMF microprocessor chips were soon developed for not only sending out tones, but also receiving these tones, and activating a circuit. Amateur radio operators have been using DTMF to patch through to telephone systems for years, but it wasn't until recently that DTMF decode capabilities could also be available with just the inclusion of one more tiny chip inside the set.

Some ham manufacturers called it selective signaling, yet others called it digital squelch calling, still others called it dial tone

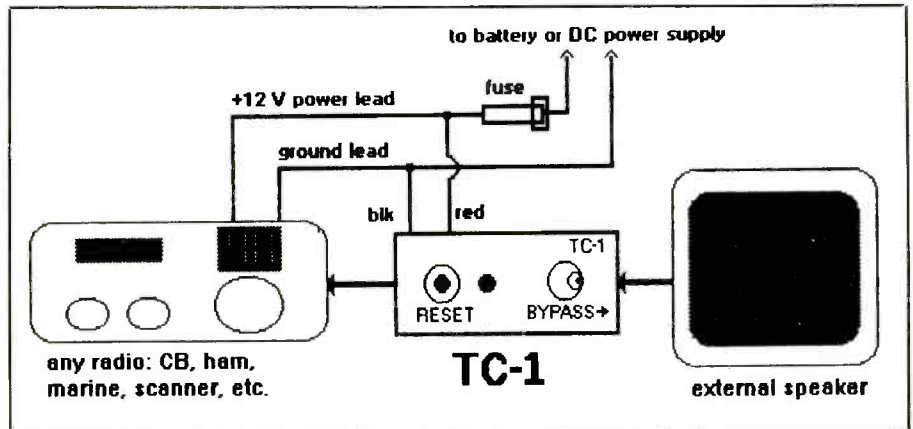

Typical hookup of external decoder.

signaling. Regardless of what name it goes by, a "DTMF" sequence could trigger a handheld, mobile, or base station to open squelch, and allow the operator to hear the incoming call. At all other times, regardless of channel activity, the radio would be absolutely silent.

DTMF should not be confused with sub-audible tone—subaudible tone mutes the receiver until that specific tone is intercepted on the airwaves. Subaudible tones are commonplace on both emergency radio bands and ham radio frequencies, and it keeps your receiver silent until your particular system comes up on the air. Until your receiver hears that single subaudible tone, it remains silent.

It is the DTMF sequence that holds the greatest utility for paging your emergency personnel as an entire group, or in specific groups, specific teams, or as individuals. The

DTMF system is universal, and it makes no difference whether or not you all have the same brand of radio or not. As long as it has "DTMF" decode capabilities, you are all set.

Some equipment requires plug-in circuits for DTMF decode. Almost all mobile, portable, and base units have encode capabilities, but it's usually a \$50 option for the little decode board module. It usually plugs right into newer pieces of equipment that may have decode capabilities.

On older equipment, as well as on most scanner receivers, DTMF decode capabilities are not available. But external add-on DTMF decoders are an easy way to add some new capabilities to your present equipment. Just unplug your external speaker, and plug in the decoder device to the external speaker output jack. Now plug your external speaker in-



The decode number for personal or group calling is key-pad entered in seconds.

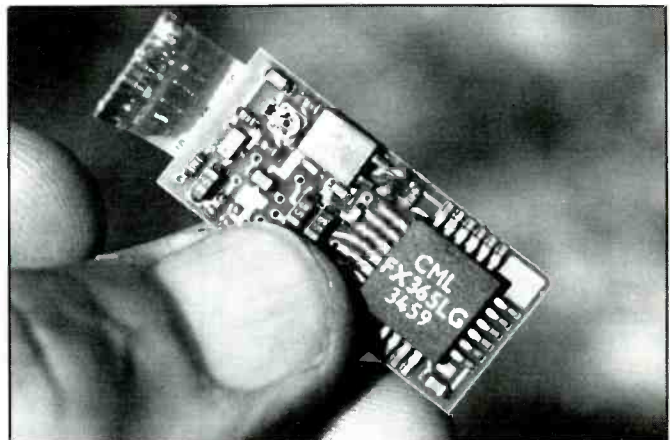

Decode DTMF board may simply plug into your handheld transceiver.



This DTMF decode device adds to any radio receiver, transceiver, or scanner.

to the decoder output jack, and you are ready to enjoy full decode capabilities.

The Amateur Radio Engineering (PO Box 169, Redmond, Washington 98073) "Silencer" is a two to four digit DTMF decoder that adds to any scanner radio, any business radio, or any ham radio. It is an external box, and conceivably could even be used on a handheld set in a base charger.

The unit runs on 12 volts DC, and simply plugs into your radio equipment's external speaker jack. It programs up through a series of internal jumpers and dip switches. As supplied by the factory, the ARE-10 is programmed to decode the DTMF tones C, 5, 6, and 9. The C is fixed, and cannot be changed. The 6 is jumper programmable for any digit, and the 5 and 9 are programmed with a 10-position dip switch and can be set to any digit you want. Programming takes about 5 minutes.

When the toggle switch is in the "monitor" position, the decoder acts as an external speaker and the DTMF decoder is not active. When the toggle switch is in the "decode" position, the decoder is activated, and the speaker is muted until the proper DTMF sequence is received.

When the programmed sequence of DTMF codes are received, the speaker turns on for 10 seconds, to enable the user to hear a voice call. After this time, the speaker will again be silent, but the call indicator LED will stay illuminated so you know that you have received a call.

On equipment that has the decoder built in, setting up your own personal number requires some careful reading of the instruction manual. Let's say you are working with a local rescue squad, and they have split 10 radio operators into two 5-person teams. Let's call the teams "Team 1" and "Team 2".

Each member of Team 1 has a DTMF

number group code of 111. Each member of Team 2 has a group code of 222.

If the dispatcher wants to get a hold of Team 1, they would simply send out a DTMF code of 111. All the other radios of Team 2 are silent because they did not receive their own group code.

If you carefully plan your numbers strategy, you could set up a DTMF calling system where you could call any one individual member, a group of 10 individual members, or call them all. This is known as "selective calling", and newer equipment now has this capability built in.

If your base station does not have DTMF encoding capabilities, an inexpensive Radio Shack (TM) DTMF encoder does the trick nicely (Part #43-139). Just hold the little telephone dialer firmly against the microphone, hit the transmit button, and then hit the proper digits.

In the "tone-call" TC-1 tone alerting system

from Robert Bellville, PO Box 892, Northboro, Massachusetts 01532, his little \$30 TC-1 module will work in any type of radio, and decodes a single DTMF tone picked off of the audio output section. The decode tone single digit is preset by the factory.

The DTMF system appears to be the most popular signaling system for the future. More and more radio sets now have multiple DTMF decode capabilities, and almost all newer radio sets have DTMF encode capabilities as soon as you take the unit out of the box. If it doesn't have a push-button microphone, you can sometimes buy it as an option. Even the little telephone dialer will work nicely through most radio transmitters.

So if you are tired of hearing all of the static on the channel you have been assigned, do consider DTMF decoding. Whether it's built-in, or purchased as an optional add-on box, it will really give your ears a break in the middle of the night.

**212-925-7000**

**SHORTWAVE RECEIVERS, HAM RADIOS, BOOKS, ANTENNAS, SCANNERS, Business Radios, ICOM, YAesu, KENWOOD, SONY, PANASONIC, MOTOROLA.**

... our 40th Year ... Worldwide shipping.  
Sales ... Service. Large Showroom. Open 7 days.

**Barry Electronics Corp.**  
WORLD WIDE AMATEUR RADIO SINCE 1980  
Your one source for all Radio Equipment!

Fax 212-925-7001  
512 Broadway, NYC, NY 10012

CIRCLE 54 ON READER SERVICE CARD

**SUPER-MINIATURE FM TRANSMITTER**

**NEW! POWERFUL! XST500 SUPER-MINIATURE** transmitter uses Surface Mount Technology (SMT)! Smallest high performance FM transmitter available anywhere. Transmits whispers to any FM receiver up to a mile away. Uses 9V battery. Complete, easy to assemble, kit with all SMT parts already assembled to circuit board. Call our free 800 order number and order one today!

**XST500**

**\$39.95** CHECK, VISA, or MC  
COD ADD \$5.00

TECH INFO 1-602-829-8152  
ORDERS ONLY 1-800-336-7389

**XANDI ELECTRONICS, Dept PC**  
201 E Southern Ave, Suite 114  
Tempe, AZ 85282

**ORDER NOW!!!**

Or write for catalog today!

CIRCLE 19 ON READER SERVICE CARD

**SURVEILLANCE**

**COUNTERSURVEILLANCE Electronic Devices Catalog...\$5.00**  
Miniature Surveillance Transmitter Kits... \$39.95ppd.  
Voice Changers, Phone Scramblers, Vehicle Tracking, Phone Recording Systems, Bug & Phone Tap Detectors, & More!

**CALL IDENTIFIER** displays callers phone number, stores phone number with date & time of call...\$59.95ppd.

**E D E** P.O. Box 337, Buffalo, NY 14226 (716) 691-3476

## YOU AIN'T HEARD NOTHIN'...YET

Since 1967, CRB Research has been the world's leading publisher and supplier of unique hobby and professional books and information including:

- Scanner Frequency Guides
- Shortwave Frequency Guides
- Military/Federal Communications
- Broadcast Station Registries
- Undercover Communications
- Survival Communications
- Covert Operations
- Electronic Espionage
- & Other Related Topics

**CRB RESEARCH**  
**P.O. Box 56,**  
**Commack, NY 11725**

**Computer Control of Your Radio**  
with  
**SCANCAT**

JUST RELEASED VER. 4.5

Computer Aided Software Control

Never buy another program - SCANCAT runs ALL supported radios  
LOOK WHAT WE NOW SUPPORT !

FLASH 1111, DRAKE R-8 & AOR-2500, FLASH 1111  
• KENWOOD R-5000, TS-440, TS-450, TS-950, TS-711  
• YAesu FRG-9600, 757GX  
• JAPAN RADIO NRD-525 and NRD-535  
• AOR-3000 with SPECTRUM DISPLAY/ANALYSIS  
• MOST ICOMs including R-71, R-7000 & R-9000

Icom & Yaesu FRG-9600 scan stop with inexpensive optional cable III

Once you use SCANCAT with your radio - You will never use your radio again without SCANCAT!

**AOR-3000, NRD-535, ICOM, FRG-9600 FEATURES**

- \* Automatic signal detection/scan stop
- \* Save Load radio's memories to disk
- \* Automatic logging to diskfiles
- \* Spectrum Analysis - Terrific graphics!

**UNIVERSAL FEATURES**

- \* Create Frequency Databases
- \* Scan by ANY increment - by any Delay
- \* Scan between any frequencies
- \* Built in Communications program for TNC
- \* Up to 400 Frequencies per file
- \* Share ANY radio's files with another radio

**SCANPORT**

Now with version 4.5 we include SCANPORT, an ASCII text reader that imports almost ANY columnar frequency list to a running SCANCAT file. Now you can convert your existing databases and download off BBS's without having to retype everything again. The best part is it's free with your purchase

**FREE INFORMATION** - or - Send for our fully operational Demo (\$5.00). We're so convinced you'll buy SCANCAT, that when you do, we'll refund the cost of the Demo and even pay the postage!

Requires IBM - MS-DOS Compatible - Minimum 1 Serial Port & One Floppy

**\$ 49.95** +\$5.00 P & H (Foreign add'l \$2.00)

ICOM CABLE \$19.95 - YAesu FRG-9600 CABLE \$24.95  
Visa - Mastercard - Discover - AmExp or COD

FREE FILE - (Specify your Choice) - CELLULAR or TDP200 UTILITIES  
J&J Enterprises- 4001 Parkway Dr. - Bossier City, LA 71112  
PHONE 318-631-3081 (10-5) or FAX 318-631-3082

CIRCLE 49 ON READER SERVICE CARD

# COMMUNICATIONS CONFIDENTIAL

## YOUR GUIDE TO SHORTWAVE "UTILITY" STATIONS

A reader signing himself as "Listening Post in Winston-Salem, NC" wrote the following: "I like tinkering with old radios, and have recently gotten into 49 MHz. I've been scavaging old baby room monitors for the parts to build a five channel transceiver on the license free hobby band. I found a strange one called a "Baby Minder" made in Hong Kong in 1984. With the transmitter unplugged I heard CW identifier "LZB." When I hooked a longwire (150 ft) antenna to the receiver's ground, the signal level increased to a very clear listening level and some single sideband transmissions were easily heard."

I checked my references and do not have a LZB Beacon listed, but there is a LZB which is the Bulgarian Telegraph Agency in Sofia, Bulgaria operating on 7460 kHz???

Ary Boender in the Netherlands reported he had "close encounter" with the "P" beacon on 3807//4043 kHz. Here is what he said: "I tuned in at 2122 UTC. The beacon transmitted its 'P' marker in CW. At 2125, a transmission in RTTY started with a speed of 75 bauds. The messages were in 5L groups. At 2130 the 'P' marker took over again. I decided to monitor these frequencies for another hour, hoping the whole scene would start again at 2230.

I was lucky because at 2200 the show started again, but slightly different this time. Again there were 5L group messages. The schedule was as follows: 2159 CW 'P' marker. 2215 RTTY, 50 bauds, 5L group messages. 2229 CW 'P' marker.

The following two nights I tuned in at the same time, but only the 'P' marker was there. I heard the 'P' RTTY messages before, but I never noticed two different baud rates and such an extended transmission."

For quite some time I have been of the opinion that the designation of SLHFB for the above type single letter identifiers could be made more definitive by calling such signals SLHFM with the M standing for marker. At the risk of creating a controversy, I plan to label such transmissions in the logging section as SLHFM's in the future.

A note from Perry Crabill, VA indicated he is very satisfied with his new Drake R-8 receiver. "I have logged five LW beacons not previously logged, including un-ID station GRT on 518 kHz. I use the same tuning technique I followed with the Kenwood R-5000; i.e., USB mode with the 0.5 Hz filter and Passband tuning. The R-8 notch filter skirts seem a little steeper. The Noise Blanker is very good, on a par with the R-5000."

Retired FAA Supervisor Ralph Craig, OH was the first to identify the mystery installation which Ernie Rice, OH had photographed. Ralph described the site as a LOM (Locator Outer Marker) combined with a OM

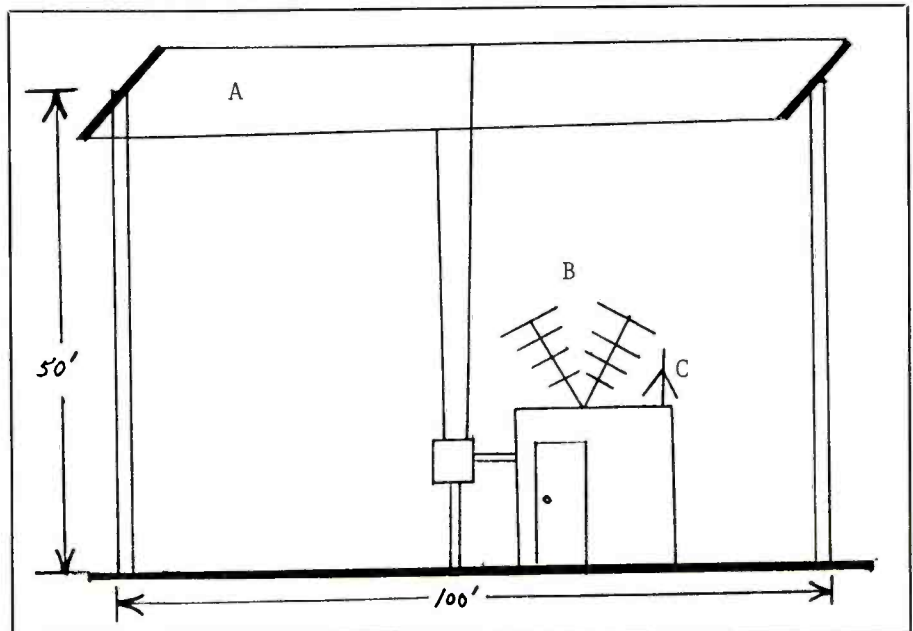

Figure 1

(Outer Marker). "The antenna that is 'vee' shaped (B in Fig. 1) is a dipole backed by a reflector with a director in front. It is the antenna for the Outer Marker. The beam projected by the antenna is a fan shaped pattern, wide in width and narrow in thickness. The beam is orientated perpendicular to the centerline of a runway. The transmitter operates on 75 MHz and is modulated with continuous dashes at an audio frequency of 400 Hz.

The other antenna (A in Figure 1) which is supported by 2-50' towers separated by 100' is the antenna for the LOM. It operates in the low frequency range from 200 to 400 (or sometimes above) kHz. It is modulated with 1020 Hz tone keyed with the 3 (or 2) letter identifier for the site.

The ground plane antenna mounted on the shack (C in Fig. 1) is for use when communicating with a flight check aircraft.

The LOM/OM is associated with a ILS (Instrument Landing System) located on a runway at an airport. Typical distances for the OM/LOM to be located from the end of the runway is 5 miles. If the runway is a full ILS there will be a second station called a MM (Middle Marker) with the 'vee' antenna but with no LF beacon, located about 1300 feet from the end of the runway. If the ILS is a partial system there will be only a OM and may or may not have a LOM depending on the airport."

Our thanks to Ralph for his informative letter and thanks also to Roger Pience, Wash., DC and Daryll Symington, OH. Both of these readers also supplied similar details regarding the aeronautical installation.

When Dan Grote, IL received his QSL from the Boston, MA Coast Guard station, it was accompanied by a copy of the Broadcast Schedule for NMF/NIK and some technical information describing the receiving and transmitting installations.

"Communication Station Boston has its primary receiving and operations site on 57 acres of land in Marshfield, MA., about 35 miles south of Boston. The transmitter site covers 542 acres within the Otis Air National Guard Base on Cape Cod. Additionally, the station operates an unmanned microwave site at Manomet, MA and an unmanned remote-controlled receiver site at East Moriches, Long Island, New York. The various sites are interconnected by microwave and landline links.

Communication Station Boston uses 30 Harris R-2368/URR LF/MF/HF receivers at Marshfield. They are connected to a Hermes aperiodic loop array (MF/HF omni directional antenna).

At the Cape Cod transmitter site there are twelve state of the art Collins HF-80 HF transmitters capable of 10,000 watts and two Nautel NX2500 TT/6 MF transmitters. They can be patched to 18 antenna: 10 fixed directional, horizontal log periodics; four omni-directional, horizontal log periodics, 1 omni-directional vertical inverted cone (HF); 2 omni-directional horizontal flat-tops (MF) and 1 omni-directional vertical dipole (MF)."

Gary Hamlin, NY wrote "It's been a while since I last sent in a report. My interest hasn't faded, but other business has unfortunately kept me away from the receiver too much of



UNITED STATES COAST GUARD CUTTER SHERMAN (WMEC 720)

THIS WILL VERIFY YOUR RECEPTION OF STATION **N2OHO** ON 6200 KHZ USB AT 0515 Z ON 13 SEPTEMBER 1989.

TRANSMITTER/POWER: ITT MACKAY MSR-1626 / 250 WATTS

ANTENNA: LONG WIRE (FAN)

LOCATION: INDIAN ISLAND, WASHINGTON

VERIFYING OFFICIAL AND STAMP:

*TW [Signature] RMC, USCG  
RADIOMAN-IN-CHARGE*



This will verify your reception of vessel:

CASON J. CALLAWAY

Type: Bulk carrier Tonnage: 12309.5 Gross TONS

Frequency: 4077 KHz Call sign: WE4879

Date: Sept. 20, 1991 Time: 2244 EDT

Antenna: Approx 40 FT of Wire Power: 150 watts

Signature: *Peter H. [Signature] 2nd Mate*

Ship's stamp:

**CASON J. CALLAWAY**

*Russ Hill, MI used this PFC for this reception verification of a maritime vessel.*

*This Prepared Form Card was made up by Dave Sabo, CA.*

the time. Preparing for an eventual change of address has kept me busy, as has finally earning my ham license, callsign, N2OHO.

The YL/GG with 3/2F groups on 7375 kHz is undoubtedly the same one as reported by Simon Mason in the February 1992 column; she's the one who says 'noyner' for 'nine.' I wasn't quite able to place the accent of the YL/EE on 6810 kHz. Her pronunciation of 'five' sounds something like 'fuy-vuh,' and she really rolls her R's."

Thanks to Gary and glad to have your loggings again.

Sergeant John Benson IV is on duty with the U.S. Army and stationed in Germany. "I am writing to the magazine for the first time. I read it quite often but have never really had any time, in the past, to contribute to the columns. Recently, I have had much more free time to spend with hobby SWL'ing. I am fairly new to the SWL hobby. I have had my set for about three years now and at first I used it just to listen to the BBC or Radio Canada International and such. Now I enjoy all aspects of the spectrum. For my listening pleasure I have a Yaesu FRG-8800 hooked up to a sixty foot random wire antenna. For the non-voice stuff I have a PK-232MBX hooked up to my IBM PC/286."

Welcome to the column, John, and we are looking forward to receiving loggings from you.

Ed Rausch III, NJ uses a DX440 with an Eavesdropper Antenna and he advises he says his very first verification from KMI High Seas station. The QSL letter included a color postcard of the transmissions site with station information, a booklet which described the AT&T High Seas Radiotelephone Service, and a business card. Ed added that he plans to get a PC to copy CW and RTTY.

John Bryson, PA sent in some beacon loggings and indicated he was a first time contributor to the column. He uses a Realistic DX-440, and an old Zenith Trans-Oceanic receiver.

John asked, as did a number of other read-

ers, for a source of information on beacon identification.

The reference I use is the *Aero/Marine Beacon Guide*. It's put out by Ken Stryker, 2856-G West Touhy Avenue, Chicago, IL 60645.

Before closing for this month I want to mention an unidentified signal I just recently observed. The frequency was 13487.3 kHz and the time was 1603-1612 UTC. Two tones were noted (a low tone followed by a higher tone) these were followed by a burst of 6-7 seconds. Sometimes in the background I could very faintly hear a similar transmission. Perhaps this was a response? The pauses between transmissions varied in length. I can use some help on this one.

**Ute Intercepts. All Times Are UTC.**

- 201: Beacon APF, Naples, FL at 0020. (Ed., FL)
- 206: Beacon VNC, Venice, FL at 0021. (Ed., FL)
- 215: Beacon ARU, Alturas Municipal, CA at 0856. (Vaage, CA)
- 216: Beacon CLB, Wilmington (Carolina Beach), NC at 0618. (Bryson, PA)
- 242: Beacon CX, Cranbrook, BC, Canada at 1254; Beacon ZT, Port Hardy, BC, Canada at 1443. (Arens, BC, Canada)
- 257: Beacon SQT, Melbourne, FL at 2358. (Ed., FL)
- 260: Beacon OLZ, Oelwein, IA at 1155. (Crabill, VA)
- 269: Beacon HLX, Hillsville, VA at 0445. (Crabill, VA)
- 271: Beacon TKW, Tillamok, OR at 1208. (Arens, BC, Canada)
- 272: Beacon XS, Prince George, BC, Canada at 1104. (Arens, BC)
- 286: Beacon OE, Dry Tortugas LS, FL at 0028. (Ed., FL)
- 290: Beacon AOP, Rock Springs, WY at 1113; Beacon YYF, Penticton, BC, Canada at 1149. (Arens, BC, Canada)
- 305: Beacon X, Passage Island LS, MI at 0132. (Crabill, VA)
- 306: Beacon Y, Main Duck Island LS, Ont, Canada at 0856. (Crabill, VA)
- 311: Beacon H, Devils Head, Nfld, Canada at 0029. (Ed., FL)
- 317: Beacon DC, Princeton, BC, Canada at 1230; Beacon XJ, Fort St. John, BC, Canada at 1129. (Arens, BC)
- 328: Beacon LD, Chibougamau, Que., Canada at 0358. (Crabill, VA); Beacon BZJ, Indiantown Gap, PA at 0624. (Bryson, PA)
- 335: Beacon PV, Providence, RI at 1444. (Caldicott, MA)

- 338: Beacon PBT, Red Bluff, CA at 1218. (Arens, BC, Canada)
- 341: Beacon FM, Ft. Myers, FL at 0031. (Ed., FL)
- 342: Beacon O, Ottawa, Ont., Canada at 1335. (Crabill, VA)
- 347: Beacon Z8, Rivere Ouelle, Que., Canada at 0453. (Crabill, VA)
- 353: Beacon LWT, Lewiston, MT at 1105. (Vaage, CA); Beacon LLD, Lanai, HI at 1143. (Arens, BC, Canada)
- 356: Beacon HIX, Hopkinsville, KY at 0518. (Crabill, VA); Beacon PB, West Palm Beach, PL at 0035. (Ed., FL)
- 357: Beacon IM, Asheville, NC at 1416. (Crabill, VA)
- 364: Beacon CKK, Miami, FL at 0036. (Ed., FL)
- 366: Beacon YMW, Maniwaki, PQ, Canada at 0627. (Bryson, PA)
- 376: Beacon ZIN, Great Inagua, Bahamas at 0630. (Bryson, PA)
- 379: Beacon SF, San Francisco International, CA at 1110. (Vaage, CA); Beacon GKQ, Newark, NJ at 0631. (Bryson, PA); Beacon TL, Tallahassee, FL at 0010. (Ed., FL)
- 380: Beacon BBD, Brady, TX at 0625. (Crabill, VA)
- 381: Beacon BM, Bloomington, IN? at 0633. (Crabill, VA)
- 382: Beacon YE, Fort Nelson, BC, Canada at 1259. (Arens, BC, Canada)
- 382: Beacon SZY, Selmer, TN at 1205. (Crabill, VA)
- 388: Beacon AM, Tampa, FL at 2332. (Ed., FL)
- 391: Beacon DDP, San Juan, PR at 0634. (Bryson, PA); Beacon MMS, Marks, MS at 1213. (Crabill, VA)
- 392: Beacon CLY, Worcester, MA at 1448. (Caldicott, MA)
- 395: Beacon SB, San Bernadino, Norton AFB, CA at 1121. (Vaage, CA)
- 396: Beacon GOL, Gold Beach, OR at 1308. (Arens, BC, Canada); Beacon ZBB, South Bimini, Bahamas at 0038. (Ed., FL)
- 398: Beacon FTT, unidentified. (Benson, Germany)
- 402: Beacon LW, Lawrence, MA at 1442. (Caldicott, MA)
- 406: Beacon FLR, Fall River, MA at 1440. (Caldicott, MA)
- 414: Beacon RTB, unidentified. (Benson, Germany)
- 415: Beacon CBC, Cayman Brac, BWI at 0012. (Ed., FL)
- 435: Beacon BR, unidentified. (Benson, Germany)
- 472: NMF, USCG, Boston, MA in CW kat 1525 w/notice re 21 blue drums containing arsenic troxin which is a danger to anyone exposed to it. Mariners off the coast of Virginia, Maryland, Delaware and New Jersey advised keep a sharp lookout for these drums. Notice indicated no attempts should be made to recover the drums but rather notify the Coast Guard immediately. (Caldicott, MA)
- 482: Beacon SWH, unidentified. (Benson, Germany)
- 489: VAU, Yarmouth, NS, Canada in CW at 2330 w/notice to mariners of location of extinguished light

**Abbreviations Used For Intercepts**

AM	Amplitude Modulation mode
BC	Broadcast
CW	Morse Code mode
EE	English
GG	German
ID	Identifier/led/location
LSB	Lower Sideband mode
OM	Male operator
PP	Portuguese
SS	Spanish
tfc	Traffic
USB	Upper Sideband mode
w/	with
wx	Weather report/forecast
YL	Female operator
4F	4-figure coded groups (i.e. 5739)
5F	5-figure coded groups
5L	5-letter coded groups (i.e. IGRXJ)

**NMF/NIK BROADCAST SCHEDULE**

TIME	TYPE	MODE	FREQUENCY
0030Z	SITOR 6312.3/8414.8/12577.3KHZ	FSK	
0045Z	"NAVTEX" MARINE INFORMATION BROADCAST <i>Marine weather, navigational warnings distress and urgent broadcasts</i>	FSK	518KHZ
0050Z	INTERNATIONAL ICE PATROL BROADCAST 5320/8502/12750KHZ <i>Ice patrol bcsts are sent by NIK between the months of March and July</i>	CW	
0130Z	CW MARINE INFORMATION BROADCAST <i>Marine weather, notices to mariners, distress and urgent broadcasts</i>	CW	472KHZ
0440Z	MARINE INFORMATION BROADCAST <i>Marine weather, navigational warnings, distress and urgent broadcasts</i>	USB	2670KHZ
0445Z	"NAVTEX" MARINE INFORMATION BROADCAST	FSK	518KHZ
0530Z	NATIONAL WEATHER SERVICE RADIOFACSIMILE <i>Wave and wind charts</i>	USB	3242KHZ
0845Z	"NAVTEX" MARINE INFORMATION BROADCAST	FSK	518KHZ
1040Z	VOICE MARINE INFORMATION BROADCAST <i>Marine weather only</i>	USB	2670
1218Z	SITOR INT'L ICE PATROL BROADCAST 8414.8/12577.3KHZ	FSK	
1245Z	"NAVTEX" MARINE INFORMATION BROADCAST	FSK	518KHZ
1250Z	INTERNATIONAL ICE PATROL BROADCAST 8502/12750KHZ	CW	
1350Z	NOTICE TO FISHERMEN BROADCAST <i>Fixed fishing gear notices</i>	CW	472/8502KHZ
1450Z	MARINE INFORMATION BROADCAST	CW	472KHZ
1600Z	INTERNATIONAL ICE PATROL RADIOFACSIMILE 8502/12750KHZ <i>Ice charts</i>	USB	
1630Z	"SITOR" MARINE INFORMATION BROADCAST 8414.8/12577.3/16804.8KHZ	USB	
1640Z	VOICE MARINE INFORMATION BROADCAST <i>Content same as 0440Z broadcast</i>	USB	2670KHZ
1645Z	"NAVTEX" MARINE INFORMATION BROADCAST	USB	518KHZ
1730Z	NATIONAL WEATHER SERVICE RADIOFACSIMILE	USB	7530KHZ
2045Z	"NAVTEX" MARINE INFORMATION BROADCAST	USB	518KHZ
2150Z	NOTICE TO FISHERMEN CONTINUATION BCST <i>Only sent in the event the 1350Z notice to fishermen bcst overlaps into the 1450Z scheduled bcst</i>	CW	472/8502KHZ
2240Z	VOICE MARINE INFORMATION BROADCAST <i>Marine weather only</i>	USB	2670KHZ
2245Z	"NAVTEX" MARINE INFORMATION BROADCAST	FSK	518KHZ

houses & rezoned buoys. (Caldicott, MA)

**516:** Beacon YWA, Petawawa, Ont., Canada at 0639. (Bryson, PA)

**2180:** Disabled fishing vessel Cape Shark issues distress call. First contact with CG Fort Macon, NC then comms established with CG Group Woods Hole, MA. QSY to 2738 at 0240 to continue comms with Group Woods Hole. Position of Cape Shark was 70 miles off coast of Rhode Island. Hrd first at 0230. (Rausch, NJ)

**2670:** CG Group Mayport in contact w/NOAA ship Oregon II re mysterious lights and flare sightings. Comms continued until a CG Helo was dispatched from CG Air Station Clearwater. USB from 0229-0400. (Grote, IL); CG Group Woods Hole, MA in USB at 0245 assisting disabled fishing vessel Calypso. At 0312 CG Cutter Escanaba established comms w/Calypso & made schedule of comms every hours. (Rausch, NJ)

**2900:** Ganda in LSB at 0459 w/kg several airlines. Very noisy freq. (Garcia, OH)

**3417:** YL/EE in RCS w/5L grps at 0220. (Willmer, MI)

**3807:** SLHFM "P" in CW at 2200. Sent RTTY t/c of 5L grps at 50 baud. Simulcast w/4043 kHz. (Boender, Netherlands)

**4350:** TBB5, Navy, Ankara, Turkey in CW at 2217 w/VVV DE TBB5. (Boender, Netherlands)

**4415:** OM/EE in LSB at 0824 w/coded msg. ID as Juliet 33. Down at 0830. (Garcia, OH)

**4417:** Chatter between fishing vessels WRC 5245 and WYW 7185. WRC 5245 was docked in San Juan, PR awaiting repairs on blown engine. (Rausch, NJ)

**4427:** ComSta San Francisco in LSB at 0845 clg F3N, to standby and shift to 4296 kHz. Checked but no comms there. (Garcia, OH)

**4585:** CAP, Division 2 in USB at 0500. Training session rdo operation. (Rausch, NJ)

**4646:** Unid Russian in USB at 2225. 1 minute tape, same msg for hours. (Boender, Netherlands)

**4665:** YL in AM rptng phonetic VLB2 at 0246. Israeli Mossad. (Hamlin, NY)

**4722:** MVV, RAF London in USB at 0029 w/flight wx. Bad QRM. (Lish, FL)

**5015:** YL/GG in USB at 0036. Tones then numbers. (Lish, FL)

**5437:** YL rptng ART3 at 1905. At 2000 changed to ART2. Presumed Mossad station. (Mason, England); YL/EE w/English accent in AM at 0146 w/5L grps. Off at 0152 "End of Message. End of Transmission." At 0202 same YL was rptng ART2. Off at 0204. Same YL w/5L format hrd on 4880, 7445 and 7918 kHz between 0400-0500, and on 13579, 17410 and 19715 kHz between 1300 & 1800. (Johnson, NY)

**5456:** At 0349 in USB, 2 OM/EE speculating re next day's wx. One mentioned having hrd forecast for Buzzards Bay, MA. (Johnson, NY)

**5470:** YL/EE in AM at 0204 w/5F grps. (Margolis, IL)

**5562:** OM/SS in USB at 1000 clg "Oyeron Cayo Largo, Cinco Cinco Seis Dos" (5562). Also hrd Caribbean Flight 231 on this freq at 1012 hrs. Later at 1035 hrd same subj. mentioned "Cocaine" and 300 kilos, and Havana. Very short and broken language comms. No ID. (Garcia, OH)

**5598:** A/C N900J w/kg NY Radio w/Selcal check in USB at 0242. (Hamlin, NY)

**5599:** Gander & NY Radio in USB at 0125. Both wrkg vsrious aircraft. (Lish, FL)

**5696:** Slingshot w/kg Pinball 40 and 41 re vectors to target. Chase went on until pilot of the plane bailed out over the Gulf of Mexico. USB at 2323. (Grote, IL); CG Helo Rescue 1720 in USB at 0215 w/kg ComSta Miami re tug towing barge which is taking on water. (Rausch, NJ); USC Helo 2130 to ComSta Boston indicating major elec failure. Helo 1493 cld Helo 2130 to ask what was his destination. Helo 2130 responded that power was restored and he heading back to Otis from NFA (?) traffic patterns at Brunswick. (Caldicott, MA); ComSta Miami clg ComSta Boston in USB at 0536. Rescue 1435 had comms w/both, and was asked to go to 3123 kHz at 0602. Other ID hrd was PBQ-1 requesting new freq as unreadable on this one. Re rescue attempt on burning vessel, could not find it, only debris and continuing searching for vessel. Stated later that vessel had burned. (Garcia, OH)

**5735:** OM/Rumanian at 0312 in AM w/Skylark melody and ending with "Terminat" x3. (Willmer, MI)

**5781:** YL/GG rptng 649x3, 000 from 2100-05. Then off. (Mason, England)

**6501:** CG ComSta NMN, Portsmouth, VA in USB giving offshore wx forecast. (Grote, IL)

**6508:** YL/GG in AM at 0410 w/5F grps x2. (Mazanec, OH)

**6683:** AF-2 w/kg Andrews AFB in USB at 0121. (Grote, IL)

**6697:** 4EU clg 5QM in USB at 0031. 4EU asking if 5QM recd figures "0120 on Oscar Net." (Fenlon, OH)

**6730:** 5269 w/kg Lockheed Flight Test w/emitter tests in USB at 2324. (Willmer, MI)

**6738:** Royal Air Force Strike Command at 0530 w/coded msg. (Rausch, NJ)

**6761:** Texco 34 clg Doubleup in USB at 0600 requesting pp to Blacknight Control. Texco 34 advising BC of 0800 eta & that Texco 34 and 35 have been pre-cleared for customs and agriculture. (Fenlon, OH)

**6802:** YL/SS in USB at 0200 w/4F grps. (Hamlin, NY)

**6810:** YL/EE w/uniden accent w/3 + 2F grps. USB at 0130. (Hamlin, NY)

**6817:** Executive 1 Foxtrot w/kg Andrew AFB w/pp to SAM Command in USB at 2043. (Designates commercial a/c carrying members of President's family. (Hamlin, NY)

**6824:** Rumanian Skylark melody playing from 2100-2112 interspersed by OM rptng Terminat x3. Diff OM's used on various evenings. Parallel w/7387 kHz. (Mason, England)

**6835:** YL/SS cld 005 then 257 4F grps sent 0400-0452. My longest nbrs bcst. (Mazanec, OH)

**6843:** YL/SS in AM at 0600 w/5F grps. (Mazanec, OH)

**6889:** YL/ss in AM at 0509 w/5F grps. (Margolis, England)

**6924:** YL/EE in USB at 2307 rptng 265. At 2310 5F grps read slowly. Ends at 2315 w/00000. (Margolis, England)

**7375:** YL/GG in USB at 2000 w/3 + 2F grps. (Hamlin, NY)

**7417.4:** OM/EE in LSB at 1850-1855 announcing "Lar Main this is Camp Lejeune, Over." Msg rptd 20 times w/fast freq hopping and PCM interspersed. (Whitney, VA)

**7420:** YL/SS in AM at 0001. Tones at 0010 foll by 185 185 Gruppo 51 and into 4F grps. At 0018 Fini, two tones, and down. Xmtr pulled at 0020. (Rice, OH)

**7421.6:** Mayport CG Group w/kg V41 advising them of deteriorating wx conditions at 2144. USB mode. (Willmer, MI)

**7423:** YL/SS in AM at 0230 w/5F grps. Msg rptd at 0330. (Fenlon, OH)

**7450:** Air National Guard training net in LSB at 1436. 65T was net control. Net incl 51P, 54D, 65I, 63A, 65U, 70L, 64H, 57AB, 63M and 57T. (Margolis, IL)

**7522:** Unid stn in MCW at 0800 w/5L grps. (Mazanec, OH)



- 7532:** YL/GG ending 3 + 2F grps at 2348. USB. (Hamling, NY)
- 7627:** KWS78, US Embassy, Athens, Greece in CW at 2341 w/QRA/QSX mkr. (Margolis, England)
- 7655:** YL/EE in AM reading 3x8 format figure grps. Simulcast on 9090 kHz. (Grote, IL)
- 7662:** KWL90, US Embassy, Manila, Philippines in CW at 1237 w/QRA/QSX mkr. (Margolis, IL)
- 7695:** 5 dots, 1 dash rasper at 0200. (Mazanec, OH)
- 7695:** YL/GG in AM at 0400 w/813 813 813, 1-0 count rptd. At 0410 10 tones, Gruppe 179 x2 and 3/2F grps. Rptd 0426 & off at 0442 w/Ende. Sounds like she says "dru" instead of "zwei" for 2. (Johnson, NY)
- 7724:** KRH50, US Embassy, London, England in CW at 0954 w/QRA/QSX mkr. (Margolis, England)
- 7887:** YL/EE w/British accent in USB at 1929 w/5F grps. (Hamlin, NY)
- 7888:** 63 wkg 68 in USB at 1941. Later incl 78. Were helping 68 solve his problem of running RTTY xmsn. (Margolis, IL)
- 7909:** CG 2131 advising USCGC Mohawk (WMEC-913) in USB at 2102 re sighting two ships. One a 40' Haitian freighter w/insignificant nbr of people aboard. (Willmer, MI)
- 8178:** 5 dots, 1 dash Rasper at 0400. (Mazanec, OH)
- 8244.6/8768.5:** High Seas telephone network. DAN Norddeich, Germany in LSB handling tfc between Jamaica & Germany. (Rausch, NJ)
- 8296:** Tidewater Marine, Morgan City, LA in USB at 0605 wkg several offshore supply vessels re supplies on board. (Rausch, NJ)
- 8465:** YL rptng SYN2 India 1030 at 2033. Also on 5629 kHz. (Mason, England)
- 8478:** VIS, Sydney, Australia in CW at 1305 w/navigation aids & warnings. (Note: This a working freq.) (Caldicott, MA)
- 8571:** UFN, Novorossiysk rdo, USSR w/ DE UFN mkr in CW at 1838. (Boender, Netherlands)
- 8632:** XFQ, Salina Cruz, Mexico in CW at 2315 w/CQ mkr until 2323. (Margolis, IL)
- 8698:** "B" rptd in buzzy sounding morse. (perhaps FSK) Hrd at 0430. (Mazanec, OH)
- 8713:** Two OM/EE (fisherman) in USB discussing coastal hurricane that headed north NJ & was expected to hit George's Band but veered out sea. Most fishermen w/smaller vessels went into port w/small catches but larger vessels stayed out at sea to fish for the next 14 days. Contact terminated & OM's said they would look for each other at 1200 local next day on 4082 kHz. (Caldicott, MA)
- 8764:** CG San Francisco in USB at 0430 w/wx & global satellite positioning update. (Rausch, NJ)
- 8848:** NY Radio wkg American 665, United 166, American 657 in LSB at 1625. Lots of a/c tfc here. (Garcia, OH)
- 8912:** Flytrap 31 wkg Slingshot at 0114 in USB. (Grote, IL)
- 8936:** Berne, Switzerland advising TWA 3732 if London Gatwick visibility does not improve to divert to Frankfurt. (Rausch, NJ)
- 8957.5:** Shannon Volmet stn bestng in USB. (Bensen, Germany)
- 8967:** Lajes AFB Azores in USB at 0825 w/pp to Yokota AFB, Japan. Also Hickam AFM HI w/coded msg at 0840 in LSB. (Rausch, NJ)
- 8972:** Hotel (USN) in USB at 0039 clg & contacting Foxtrot and Tango w/various coordinates. (Lish, FL): Ghost-01 wkg India reporting progress on tracking a/c. USB at 0214. "Target was non-squaker, altitude unknown." Bluestar wkg 4JS and OFX w/scrambled tfc in USB at 1841. (Hamlin, NY) Restraint clg Fox Tango & Reporter in USB at 0200. Restraint stated he not receiving data relay & cud not understand why. Fox Tango asked Restraint "do you have Hershey plus 34 entered into your uniform?" Restraint responded negative, negative. I have negative Ping Pong at this time. (Fenlon, OH)
- 8984:** ComSta Portsmouth, VA wkg CG Rescue 1500 in USB at 0207. Group Corpus Christi wkg ComSta New Orleans in USB at 0211. (Hamlin, NY)
- 8993:** MAC 75431 (C-141 Lockheed Starlifter) in USB at 0430 wkg Andres Command Post. Gave position and altitude. Reported status as "mission capable however trust reverser was deactivated." (Fenlon, NY)
- 9043:** USCGC Northland (WMEC-904) in USB at 1308 with King 1, and King 2. All wkg DOD Cape w/launch support for shuttle Discovery. (Willmer, MI)
- 9090:** YL/EE rptng 1-0 count and 588 from 2100-2105. After ten tones, count 78, and into 3 + 2F grps. Also parallel w/7654.5 kHz (Mason, England); YL/EE rptng 458 x3 w/1-0 count at 2100. Then count 64 x2 and into 3/2F grps at 2105 in AM mode. (Hamlin, NY)
- 9092:** "Walking Man" sound at 0715. (Mazanec, OH)
- 9122.5:** Many USACE units hrd in USB net at 1525. This freq is channel 8. Moved to channel 10 on 12070 kHz but due to QRM from VIA bcst, they moved to channel 13 on 16382 kHz to continue w/net tfc. Net closed at 1635. (Margolis, IL)
- 10046:** Unid CW net w/calls FF/2, FFL/4, FFAE5/w/coded coms. (Fenlon, OH) FFL4 is St. Lys, France, a marine coastal station. (Ed.)
- 10051:** Dakar, Senegal in USB at 0050 making contact w/various flights. (Lish, FL)
- 10177:** YL/GG "Charlie Delta" xmsn w/3 + 2F grps. USB at 0000. (Hamlin, NY)
- 10448:** Rolling code speech inversion (voice scrambler) in USB at 1741. (Margolis, England)
- 11108:** YL/GG "Papa November" xmsn. 3/2F grps in AM at 1800. (Hamlin, NY)
- 11062:** Unid CW stn sending 555 x3, 817 x3, and 23 x1 at 1900 then into 5F grps at 1905. Full nbrs, not cut. (Hamlin, NY)
- 11190:** YL/EE with 997 x3, 20127, 048 from 2100-21087. Then five tones and into 5F grps. Also on 14930 kHz. At some time YL/GG using some voice on 7375 kHz with with 868 x3, 08338, 111 foll by five tones and into 5F grps. Sked every Friday. (Mason, England)
- 11214:** Chalice Bravo at 1731 in USB w/pp's via Trenton to Sleekness (101st Tactical Control Squadron), Roadstead (102nd TCS) and Footrope (103rd TCS) trying to setup JIDS training. (Willmer, MI)
- 11245:** MAC 00467 in USB at 1405 wkg McDill AFB for landing instructions and wx for 1700. P/P comms ended at 1409. (Garcia, OH)
- 11255:** Zero Lima Foxtrot in USB at 1623 w/coded msg. (Margolis, IL)
- 11300:** Tripolis Aeradio in contact w/Khartoum Aeradio in USB at 0252. (Grote, IL)
- 11387:** Sydney, Australia w/light wx for Sydney and Melbourne. USB at 1331. (Lish, FL)
- 11396:** NY Radio wkg American 665, American 1400, USB at 1533. 8846 kHz given as secondary freq. Continental 024 wkg NY. (Garcia, OH)
- 11451:** Bell Telephone net in USB at 1606 wkg WNFT 417, Wash., DC, WNFT 417 Unit 2, Red Bank, NJ, and WNIC 426, Chicago, IL. Later QSYed to 15603 kHz (Ch. 8). (Willmer, MI)
- 11634:** Andrews AFB in USB at 1624 in comms w/unid stn. (Lish, FL)
- 12210:** KWA80, unid CW at 1530 w/QRA/QSX mkr. (Margolis, IL) Several contributors in past have placed location as either Korea or Japan?? (Ed.)
- 12256.9:** GBTT, Queen Elizabeth II in USB at 2057 w/pp via WOM. At 2107 3EKU5, Panamanian dry cargo ship "Channel Commander" clg Madrid radio. (Margolis, IL)
- 12615:** UBN, Zhdanov rdo, Ukraine in CW at 1735 w/CW mkr & ARQ phasing. (Boender, Netherlands)
- 12984:** VNG, Lyndhurst, Australia time station w/CW ID over time pips at 1945. (Hamlin, NY)
- 13101:** Capetown radio w/id in USB. (Grote, IL)
- 13201:** MAC 60194 wkg Thule at 1449 in USB w/pp to unid. Pilot said fit was due in over two hours but due to wx conditions he may request diversion. Will call back in 2 hours. (Caldicott, MA)
- 13207:** AF-1 comms in USB at 1748 w/Andrews AFB re problems w/PP panel but to maintain the patch. Departure from Kansas City, KS within minutes & ETA to Crown 1 hour 45 min. President on board. (Garcia, OH)
- 13240:** Gander radio in USB at 1322 w/Canada flight wx. (Lish, FL)
- 13253:** 7 raspy dots, 1 raspy dot. Hrd at 2030. (Ed., FL)
- 13330:** Houston ARINC wkg Challenger 300S in USB at 2336. (Grote, IL)
- 13351:** Air France company freq. All comms in French. Hrd at 2135. (Rausch, NJ)
- 14295:** Shuttle Discovery launch comms in USB at 1350 via WA3NAN, Goddard Space Flight Center, Greenbelt, MD. QRM from adjacent freqs but readable. Also using 7185, 3860 kHz. (Garcia, OH)
- 14494:** T4C, unid CW at 1620 sending 120 grp msg. Each msg sent twice then DTG changes from 1030 to 1100 and new text sent twice, etc. (Margolis, IL)
- 14703:** YL/EE in AM at 1500 w/916 x3 and count 1-0. Warblers on at 1508. Checked freq at 1515 YL was off air. Warblers hrd on & off til 1525. At 1527 YL started xmsn again. 916 x3, count 1-0 etc. Count 225, 3/2F grps and rptd at 1557. Off 1617. No warblers after 1525. (Johnson, NY); YL/EE w 1-0 count and 989 from 1300-1310. After ten tones into 3/2F grps. Also on 10265 kHz. (Mason, England)
- 14945:** YL/Yiddish in AM at 1442 w/5F grps. (Margolis, IL)
- 15682:** YL/EE w/5F grps each rptd twice at 1618. Faint warblers also QRM fm WWCR on 15690 kHz. Simulcast on 14487 kHz which had loud warbler jamming. Same day at 2045 same YL hrd on 9251 kHz, barely audible, simulcast on 8464 kHz which came in better. 7887 kHz too noisy to hear anything. (Johnson, NY)
- 16372:** "Vive la Comagnie" tune in USB at 1704 foll by YL/EE w/5F grps. Parallel w/14487 kHz. (Margolis, IL)
- 16459:** YL/EE in USB at 1421 w/4F grps. Very weak sig & voice QRM on top of sig. (Ed. WV)
- 16923:** OFJ7, Helsinki, Finland in CW at 1125 w/QSX. (Boender, Netherlands)
- 16949:** UPW2, Liepaja, Latvia in CW at 0938 wkg unid ship in cyrillic text. (Boender, Netherlands)
- 16986:** CTP, NATO Lisbon, Portugal in CW at 1052 w/QSX. (Boender, Netherlands)
- 17015.8:** SLHFM "P" in CW at 1005. (Boender, Netherlands)
- 17016:** SLHFM "C" in CW at 0956. (Boender, Netherlands)
- 17245:** Portishead, England in USB w/msg fm Minister of Defense that no registered vessel of Great Britain is allowed inside the waters of Algeria. Note: This msg was rcvd during internal crisis between the Algerian Govt and dissidents. (Caldicott, MA)
- 17251:** OM/EE in USB at 2209 w/wx forecast prob for North Atlantic Ocean. Prob CG stn. (Long, WV)
- 17479.8:** A2, DE D1 Y42 AAA MSG NR 90834 BK WMF ZPS VAH OGX RZJ K. This recd at 2214. After short pause same heading sent but with msg serial nbr increased by 1. Text of diff trigraphic grps. Short pause and then same heading again with serial nbr up by 1 and new text. Continued this way until about 2220 when went down. (Ed., WV)
- 17520:** Dwarfish in USB at 1426-1511. Oprs OM/EE & YL/EE mentioned Ft. Bragg & info re C-130 mission. (Lish, FL)
- 17995:** Bubble sound comms, no voices then Dandelion in USB at 1752 saying "nothing heard, this is on LSB." 1807 hrd German Air Force calling. (Garcia, OH)
- 19987.4:** CLP5, Cuban Emb, Moscow DE CLP1, Havana, Cuba. Sends V's then sez QSV. Other end not hrd. CW at 1413. (Ed., WV)
- 19955.5:** Importer (overseas) in USB running pp's w/Doorfish Alpha (stateside) mornings for a few weeks. (Willmer, MI)
- 20753:** HBC88, ICRC, Geneva, Switzerland in USB at 1453 wkg unid w/ICRC tfc in French. (Margolis, IL)
- 20936.8:** MARS stns NNN0CSW clg NNNOPRQ w/priority call. NNN0NIP clg PRQ, NNN0NXN clg PRQ. All between 1430-1500. (Benson, Germany)
- 22042:** WOM, High Seas Pensuco, FL w/Captain of unid vessel 1955 notifying ship office they diverted to Surinam because crew member had heart attack. Vessel now on way to Argentina. (Rausch, NJ)
- 22330.5:** D3E, Luanda, Angola in CW at 1850 on ship RTTY channel 92.?? (Margolis, IL)
- 22619.5:** VCS, Halifax CG, NS, Canada in CW at 1722 w/VVV-CQ mkr. (Margolis, IL)
- 22711:** Coast Guard ComSta Honolulu wkg unid aircraft. Hrd at 1025. GKT, High Seas Portishead, England trying work vessel GYXG then works tfc w/ELNP4. Remark made by coast stn "believe it or not, somebody calling the Coast Guard in Hawaii is covering you up." Rausch, NJ)
- 22780:** EHY, Madrid, Spain in USB at 1900 w/phone tfc. (Lish, FL)
- 22807:** PPR, Rio de Janeiro, Brazil in USB at 1922 w/phone tfc. (Lish, FL)
- 23104:** YL/EE in AM at 1714 w/3 + 2F grps. (Margolis, IL)
- 23165:** North Korean Embassy, Paramaribo, Surinam in CW at 700 w/msgs sent after RTTY xmsn. (Margolis, IL)
- 23760:** Protocol in LSB at 1735 wkg Utah while making xmtr adjustments. (Margolis, IL)
- 24140:** YL/SS hrd at 1407 w/444 x3, 1-0 count rptd. Then 10 tones Group 163 x2 and into 4F grps. Rptd at 1424 and off at 1437 w/"Fin". Slight echo on xmsn. (Johnson, NY)

# WASHINGTON PULSE

## FCC ACTIONS AFFECTING COMMUNICATIONS

### **Owners/Masters Of Cargo Vessel Notified Of Forfeiture**

The Commission notified the owners and masters of the cargo vessel Kodiak Enterprise of an apparent liability for a forfeiture in the amount of \$50,000 for violation of the Communications Act. Further, the Commission notified the masters of the vessel, Jim Thill and James C. Cox, of an apparent liability for a forfeiture in the amount of \$1,000 each for willful violation of the Act. The Kodiak Enterprise was navigated on the open sea for 31 days during the period February 20, 1991, to March 23, 1991, without an annual inspection by the FCC in violation of the Act.

The Kodiak Enterprise is a United States cargo vessel of 1,584 tons, call sign WAF5936, and is subject to the radiotelephone equipment provisions of the Communications Act. It therefore must be inspected at least once each year by the FCC. The vessel may not be navigated in the open sea without meeting this requirement. The statutory forfeiture amounts for navigation without an annual inspection are \$1,000 for a ship master and \$5,000 per day for a ship owner.

From February 20, 1991, to 0500 hours on March 6, 1991, the master of the Kodiak Enterprise was Jim Thill. During that time, the vessel was navigated on the open sea for 15 days. From 1330 hours on March 6, 1991 to March 23, 1991, the master of the vessel was James C. Cox who navigated the vessel on the open sea for 16 days.

The Commission stated that inspection of the vessel is a key element in providing for the safety of life of all crews and passengers of vessels on the open seas, and that the acts of the masters to leave port and remain on the open sea on those dates without required inspection, constitutes a willful violation of the Communications Act.

### **Notified Of Apparent Liability For Forfeiture For Unlicensed Operation and Misuse Of Marine Safety Channel**

The Commission notified Geof L. Bowser of an apparent liability for a forfeiture in the amount of \$8,000 for unlicensed operation and misuse of a safety channel in the Maritime Mobile Radio Service.

A vessel identified as SUND was found transmitting on Marine Channel 70, 156.525 MHz, a marine safety channel reserved for digital selective calling (DSC) use. Washington State records show a commercial fishing license issued to Bowser for the vessel and list Bowser as its registered owner. Follow-

ing questioning by FCC field personnel, Bowser admitted that he did not have a radio station license, but had assumed that the previous owner's license was automatically transferred to him.

The Commission stated that any operation of SUND's radio station without a license was unauthorized and in violation of Section 301 of the Communications Act and the Commission's rules. Also, operating on Marine Channel 70 was in violation of the FCC's rules since that channel is reserved for DSC. Therefore, pursuant to its *Policy Statement, Standards for Assessing Forfeitures*, the base forfeiture amount for operating a private radio station without authorization is \$8,000. The Commission stated that there appeared to be no factors which would warrant adjustment of that amount.

### **Private Coast Radio Station Notified Of Apparent Liability For A Forfeiture For Use Of Unauthorized Frequency**

The Commission notified Aquatic Technical Services, Inc., of an apparent liability for a forfeiture in the amount of \$5,000 for operating on an unauthorized frequency. Aquatic is the licensee of private coast radio service station WHW856 in Eastsound, WA.

The station was observed transmitting an analog-type frequency-modulated emission on frequency 156.525 MHz (Channel 70). This is a safety frequency used only for Digital Selective Calling. Aquatic violated Section 301 of the Communications Act by transmitting on this frequency on August 11, 1991.

Pursuant to the Commission's *Policy Statement, Standards For Assessing Forfeitures*, the base forfeiture amount for transmitting on an unauthorized frequency is \$5,000. The Commission said there appeared to be no factors which would warrant an adjustment of that amount.

### **Seven NALS Issued For \$8,000 Each For Unlicensed Operation Of Radio Stations In The Maritime Mobile Radio Service**

The Commission notified seven entities that they are apparently liable for a monetary forfeiture of \$8,000 each for unlicensed operation of a ship radio station in the Maritime Mobile Radio Service.

The seven entities are:

Thomas J. & Nancy A. McIlraith, Puyallup, WA

John B. Hooper, Seattle, WA  
Astoria Cruise and Charter, Astoria, OR  
Mrs. Michael W. Schifsky, Eastsound, WA  
Paul J. Troka, Concrete, WA  
San Juan Marina, Friday Harbor, WA  
Maryann McCarty, Hammond, OR

Commission rules specify that ship radio station licenses are not transferrable. Whenever a ship radio station is sold, the station license must be returned to the Commission for cancellation and the new owner must apply for a new station authorization. Any operation of the station after transfer of ownership and prior to granting of a station authorization to the new owner is a violation of the FCC rules.

### **23 NALS For \$8,000 Issued For Failure To Light Antenna Towers**

The Commission issued 23 Notices of Apparent Liability (NALS) for \$8,000 each to 23 Private Land Mobile licensees. The notices were issued for failure to comply with FCC's rules regarding the lighting of antenna towers.

The following licensees appear to have willfully and/or repeatedly violated the FCC's rules prescribing FAA notification regarding malfunctioning lights and the painting of towers:

Basic Service, Inc., Churchville, MD  
William Suit, Churchville, MD  
Ronald Davis, Churchville, MD  
Astro Sheet Metal, Inc., Churchville, MD  
GBC Contractors, Inc., Churchville, MD  
Aberdeen Florist, Inc., Churchville, MD  
Magness Plumbing & Heating, Inc., Churchville, MD  
Paul's Utility Co., Churchville, MD  
Mid Atlantic Installation Services, Inc., Churchville, MD  
Dispatch Communications of the Mid Atlantic, Inc., Churchville, MD  
North American Teletrac: Location Technologies, Inc., Churchville, MD  
Kenneth M. Smithson, Churchville, MD  
Whiteford Construction Co., Inc., Churchville, MD  
Central Atlantic Contractors, Inc., Churchville, MD  
Corun & Gatch, Inc., Churchville, MD  
McGuire Refrigeration, Inc., Churchville, MD  
McGlothlin & Betham Electric Company, Inc., Churchville, MD  
Hartford Sands, Inc., Churchville, MD  
Genstar Stone Products Company, Churchville, MD  
Harry Fitzgerald, Churchville, MD  
Jaeger, Inc., Churchville, MD  
Central Power and Lighting Co., Alice, TX

City of Alice, TX, Alice, TX

The FCC noted that it has the authority to regulate the illumination of radio towers and that it requires licensees to observe antenna towers on which they are licensed once every 24 hours to insure that the lights are functioning properly. If lights malfunction, licensees are required to notify the FAA within 30 minutes of discovery. Furthermore, licensees are required to paint towers to maintain good visibility.

It is the Commission's policy to hold each FCC licensee on a tower individually responsible for complying with the rules relating to radio antenna towers. This policy applies even if the licensee does not own or control the tower or has contracted with another person to maintain the tower. A licensee may not delegate its obligation to comply with the FCC's antenna rules to another person.

The Commission pointed out that failure to comply with its antenna rules is an especially serious matter because of the potential dangers to aviation created by such violations.

### **PLMS License Apparently Liable For \$40,00 Forfeiture**

The Commission notified Dial-A-Page, Inc. (Dial), licensee of station KUC891 in the Public Land Mobile Service at Mt. Pleasant, TX, that it is apparently liable for a forfeiture of \$40,00 for unauthorized operation.

On January 12, 1989, Dial filed an application for authority to add a transmitting location to Station KUC891 to operate on frequency 152.24 MHz at Mt. Pleasant. Dial constructed the Mt. Pleasant station after a competing mutually exclusive application was dismissed by the Commission in October of 1990. Dial never received authorization from the Commission to operate the site. On April 2, 1991, an engineer from the Commission's Dallas Field Office, who as inspecting Dial's antenna tower in the Mt. Pleasant area contacted Dial regarding operation of the facility.

Dial claimed that it activated the transmitter on February 28, 1991, because of internal miscommunications when a technician mistakenly thought he was given permission to activate the transmitter.

The Commission found that Dial's operation of the facility without authorization constituted willful and repeated violation of the rules and assessed the forfeiture.

### **Two One-Way Paging Companies To Pay Forfeitures Totalling \$8,000**

The FCC affirmed a decision by the Common Carrier Bureau's Mobile Services Division (MSD) and ordered PJB Communications of Virginia, Inc. (PJBVA), and PJB Communications, Inc. (PJB), to forfeit \$5,000 and \$3,000, forfeiture after they violated the FCC's rules by failing to notify the Commission that they had completed construction of facilities.

PJBVA requested reinstatement of authorizations for five one-way paging facilities for Stations KPE333 and KPE335 in Northern Virginia. PJB requested reinstatement for three of its one-way paging facilities for Stations KPE333 in Maryland. Both companies sought reinstatement because they failed to notify the Commission of the completion of construction for each station as required by the Rules. The companies operated for more than six months without the required notifications. Consequently, the MSD issued notices of apparent liability for forfeitures. Both companies filed a consolidated request for remission or reduction of the forfeitures and the request was subsequently denied by the MSD.

Seeking review, PJBVA and PJB argued that the MSD failed to consider their contention that the public interest was not harmed as a result of the rule violations. They also cite economic hardship, and claimed that their voluntary disclosure of the violation and flawless FCC record should justify remission of the forfeitures.

Denying review, the Commission stated that the arguments put forth by PJBVA and PJB were insufficient to justify cancellation or reduction of the forfeitures.

### **FCC Proposes To Add San Francisco To List Of Coast Guard Vessel Traffic Service Systems; Proposes Using Marine Channel 14**

The Commission proposed adding the San Francisco, CA, port area to the United States Coast Guard's designated radio protection areas for mandatory Vessel Traffic Services (VTS). The Commission also proposed establishing marine VHF Channel 14 (156.7 MHz) as the VTS frequency for the San Francisco port area.

A VTS system is used as an advisory service to coordinate vessel movement and prevent collisions in large, busy port areas. VTS systems use VHF radios to provide communications in the Coast Guard designed VTS areas.

This proceeding was initiated by the Coast Guard as part of its program to protect the marine environment by preventing vessel collisions and groundings. Designating San Francisco as a VTS area will allow the Coast Guard to manage vessel traffic in that area more efficiently. Although the Coast Guard currently operates a voluntary VTS system in San Francisco on marine VHF Channel 13, it expressed concern that Channel 13 may become congested once participation in the VTS system becomes mandatory. It therefore requested that marine Channel 14 be allocated for VTS operations in San Francisco.

### **Teton Communications Notified Of An Apparent Liability**

The Commission notified Teton Communications Incorporated of an apparent liability for a forfeiture in the amount of \$15,000 for failing to file a notice of comple-

tion of construction and commencement of operations. Teton is the permittee of station KNKD736 in the public land mobile services at Idaho Fall, ID.

Teton constructed the facilities and commenced operation prior to the October 23, 1985 expiration date of its construction permit without notifying the FCC of completion of construction for the station as required by the Rules. By letter dated June 27, 1991, the Common Carrier Bureau's Mobile Services Division notified Teton that its authorization for station KNKD736 had expired. On July 26, 1991, the Commission received a request by Teton for Special Temporary Authority (STA) to continue operating the station pending FCC action on an application for reinstatement of the expired authorization filed with the STA request. Teton operated the station from October 23, 1985, the date of expiration of the construction permit and its going on the air and operating until July 26, 1991, the date of its request for STA and application for reinstatement without having notified the Commission when it completed construction.

Pursuant to the Commission's *Policy Statement, Standards for Assessing Forfeitures*, the base forfeiture amount for failing to file required forms is \$30,000. Consistent with this Policy Statement, the Commission adjusted the amount downward to \$15,000 because failing to notify the Commission of completion of construction is a relatively minor violation.

### **Reconsideration Of Order Establishing A Codeless Class Amateur Operator License Denied**

The Commission denied various requests for reconsideration of various aspects of its decision to establish a codeless class amateur operator license.

On December 13, 1990, the Commission adopted a Report and Order which established the Technician Class amateur operator license as the codeless class of amateur operator license. The purpose was to offer an entry-level license opportunity to otherwise qualified persons who find a telegraphy requirement an unnecessary barrier to pursuing the purposes of the amateur service.

The Commission received a number of objections to its Order. A number of the letters received argued that the FCC should have created a new sixth class of license so that codeless licensees could be readily distinguished from those having passed a Morse code examination. Other asked the Commission to reconsider the privileges of the codeless Technician Class license and that the Commission require stations where the control operator is a codeless Technician Class licensee to use a distinctive suffix after the station's call sign when the station is transmitting on the high frequency bands. A few letters disputed the need for a codeless license in any form.

The Commission stated that none of the letters met the standards of a petition for

reconsideration and presented no facts or raised any issue not already considered in the Order.

The Commission took this opportunity, however, to correct a minor error in footnote 33 of the Order called to its attention by the American Radio Relay League, Inc. The Commission correct footnote 33 by changing the phrase "the entire 23 centimeter band" to 1270-1295 MHz."

### Conditional Licensing Program In Private Land Mobile Services Upheld

The Commission upheld its decision to implement a conditional licensing program for certain qualified applications in the private land mobile radio services below 470 MHz and in the 929-930 MHz band.

The Commission dismissed reconsideration petitions seeking to exclude the proposed direct access alternative method of frequency coordination under consideration in PR Docket 88-548 from the conditional licensing procedure.

The question of exclusion of the Railroad Radio Service was addressed in the original order in this proceeding. At that time the Commission said that, although land mobile applicants were not required to participate in conditional licensing, applicants in all radio services should have an equal opportunity to benefit from the program.

The Commission noted that, although it

stated in the conditional licensing order that contemplated conditional licensing to alternative methods of coordination under consideration in the frequency coordination rulemaking proceeding, the exact nature of any frequency coordination method, including direct access, has yet to be decided. Consequently, conditional licensing may or may not be appropriate for any alternative coordination procedure that may be adopted. The applicability of conditional licensing to any alternative under consideration should be considered and decided based upon the comments filed in the frequency coordination rulemaking proceeding.

The question of exclusion of the Railroad Radio Service was addressed in the original order in the proceeding. At that time the Commission said that, although land mobile applicants were not required to participate in conditional licensing, applicants in all radio services should have an equal opportunity to benefit from the program.

### Commission And Canadian Department Of Communications Agree On Interim Channeling Arrangement For The 136-137 MHz Aeronautical Mobile (R) Service Band

On May 2, 1991 the Commission released a Memorandum Opinion and Order in GEN. Docket No. 89-295. Among other things, it

indicated that the proposed frequency sharing arrangement of the 136-137 MHz band, shown in Part 87 of the Rules (Aviation Services) would be discussed with Canada. Those discussions have now been completed. Mr Ralph A. Haller, Chief of the Private Radio Bureau of the FCC and Mr. Michael Binder, Assistant Deputy Minister of Research and Spectrum of the DOC, have signed a Confirmation of Acceptance concerning the coordinated use of the 136-137 MHz frequency band.

The Federal Communications Commission (FCC) of the United States and the Department of Communications (DOC) of Canada have agreed to an arrangement entitled *U.S./Canada Interim Channeling Arrangement for the Aeronautical Mobile (R) Service Utilizing 25 kHz Channels for the Band 136-137 MHz*. This frequency band is allocated for use by the Aeronautical Mobile (R) Service (AM (R) S) on a primary basis. The FCC and DOC have agreed to make no new assignments after January 1, 1992 to stations of the services to which the band is allocated on a secondary basis and to cease operation of any preexisting stations in such secondary services if their operation causes interferences to stations in the AM(R)S.

The Arrangement is of an interim nature pending incorporation into a replacement for the Agreement between the United States and Canada concerning the Coordination and Use of Radio Frequencies Above 39 Megacycles per Second.



## Summer Sizzlers

**Confidential Frequency List by Ferrell**  
compiled by Geoff Halligey

Brand New release of one of the most popular SWL books we carry. Fully up-to-date with all the latest frequencies, callsigns and station information. Includes listings for voice, morse code, teletype and facsimile stations. Cross referenced by call sign and frequency for easy identification. A must book for summer fun! © 1992 545 pages Eighth Edition



☐ GL-CF2 Softbound \$19.95

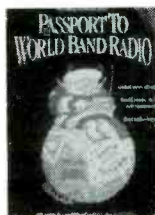

### Passport to World Band Radio

Round out your summer SWL fun by having all the latest schedules, times, frequencies and formats from international broadcasters around the world. Listings are by station and frequency for ease of use. This book has it all! ©1991 384 pages

☐ IBS-RDI92 Softbound \$16.95

Order Today! Make Summer Fun!  
Call Toll Free (800) 457-7373

Shipping: US Addresses-\$4.00 by US Mail, \$5.00 by UPS Brown. All foreign orders shipped by US Mail for postage plus \$5.00 packing and handling charge. FAX Orders (603) 899-6826. No COD orders.



**HR Bookstore**  
PO Box 209  
Rindge, NH 03461

CALL FOR  
FREE CATALOG  
AMERICAN EXPRESS

## PC HF FACSIMILE 6.0 \$99

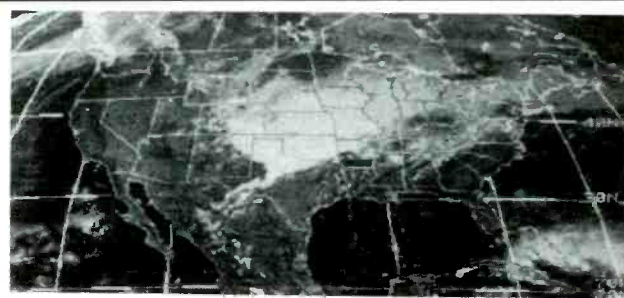

## NOW EVEN BETTER!

Version 6.0 has just been released. It is the most comprehensive fax image reception system for the IBM PC and compatibles. It includes an FSK demodulator, advanced signal processing software, tutorial cassette, and complete 250 page reference manual. The software includes the following advanced features:

Menu Driven  
Start/Stop Tone Recognition  
Unattended Operation  
Tuning Oscilloscope  
Resolution up to 1280x800x256 Levels  
Programmable Colorization  
Brightness and Contrast Control  
Transmit Option Available  
Image Zoom, Scroll, Pan, Rotation

CGA,HGA,EGA,VGA & Super VGA  
Time Lapse Frame Looping  
Slide Shows  
Export to PCX & GIF Files  
Grayscale on all Popular Printers  
Programmable IOC & Line Rates  
Online Broadcast Database  
Image Cropping  
True Color Press Photos

## PC GOES/WEFAX \$250

PC GOES/WEFAX 3.0 is our finest fax imaging system. It is compatible with both HF and direct satellite broadcasts from GOES, METEOSAT NOAA, SOVIET APT and C-Band services. It includes all of the above features plus a complete prediction system and advanced multispectral analysis software.

Call or write for our catalog of products. Visa & MasterCard welcome.

**Software Systems Consulting**  
615 S. El Camino Real, San Clemente, CA 92672  
Tel.(714) 498-5784 Fax.(714) 498-0568

CIRCLE 3 ON READER SERVICE CARD

# LISTENING POST

BY GERRY L. DEXTER

## WHAT'S HAPPENING: INTERNATIONAL SHORTWAVE BROADCASTING BANDS

As you are probably already aware, Radio Kuwait has returned to the shortwave bands! Initially, perhaps still, the service is using a single 500 kW transmitter, carrying the Radio Kuwait main arabic program to Europe and North America at 1800-2300 on 15505, 0400 to 1305 to the Gulf area on 6055 and 1315 to 1745 to the mideast on 11990. Programming in English is almost certainly in effect now. Welcome back, Radio Kuwait!

Tonga, one of the hardest countries for North American DX'ers to log, went off the air late last year. A cyclone hit the island and KO'd the Tonga Broadcasting Commission's station on 5030. It may be back by now, or it may not. The few logs of this which have been made in North America have usually been in the 0600-0800 time period.

The long-silent Dallas, Texas station, KCBI, once again has an operational schedule for the "Z-92" (Summer) period. It is listed for 0230-1400 on 9815 and 1400-0230 on 15375, beaming to Canada.

Since the first of the year Radio Afghanistan is no longer relayed by transmitters in the former USSR. Your best bet for hearing Radio Afghanistan now appears to be the external service at 1300 on 9635.

Radio Nacional, Colombia now has a weekly DX program in English. It's on 11822.5 and 17865 on Saturdays at 2330-0000. The 25 meter band frequency seems to be the most widely heard.

The newest USA religious shortwave station, WJCR, should be on the air now, broadcasting from Kentucky. Frequencies to watch are 7485, 7540, 15660 and 15675.

The Voice of Turkey has resumed its broadcasts to North America on its 9445 frequency at 2300 and 0400.

Still another new station in Russia is Radio Polis, located in St. Petersburg (ex-Leningrad) and reported to be using 6045 to 1500, presumably in Russian only.

Fifteen years ago the Romanian government closed down a shortwave transmitter site that had been used for broadcasts by the clandestine station Radio Espana Independiente. Now that site is to return to the air—a Spanish National Radio relay site! It'll be used for broadcasts to Eastern Europe but we don't know how soon it'll be active.

Radio Canada International's cumbersome QSL'ing procedure is no more. The Canadian International DX Club has taken on the job of QSL'ing reports for RCI. Reports sent to RCI's P.O. Box 6000 address in Montreal will reach the CIDX people. CIDX deserves thanks for making things easier!

Speaking of clubs, if you are looking for a European club to join, you'd have a hard time doing better than the World DX Club of England. WDXC publishes "Contact" each



Though he uses an Icom R71A, Gary K. Hamlin, N2OHO, of Utica, NY, prizes his RCA Strato-World receiver.

month and it's filled with club news, chit-chat from members, articles, a QSL report, radio nostalgia, an excellent log section and more. Dues for members outside Europe are just \$20 per year. That gets you "Contact" each month, via airmail. Dues may be sent to the U.S. rep, Richard D'Angelo, 2216 Burkey Drive, Reading, PA 19610.

NOTES IN THE MAIL—Edouard S. Provencher of Biddeford, Maine continues his efforts to hear and QSL historical events and the like. He recently confirmed two of the new Deutsche Welle Russian relays (Novosibirsk and Shigulovsk). He has a report out to Radio Moscow for a log on the date on which the agreement dissolving the USSR was signed but is worried because his reply is overdue. Edouard wonders about the stories we hear of mail rip-offs in Russia these days, and whether many letters to Radio Moscow are even reaching the station. Anyone else noticing that Radio Moscow replies take longer, or aren't coming at all? Replies from Radio Moscow used to take only four or five weeks.

Don Frederickson, Cedar Rapids, Iowa has been a reader for about five years and has been listening to shortwave for 40 years. He currently uses a Kenwood R-5000. Your unidentified on 11885 during the evenings is probably Radio Liberty, in Russian, Don.

Thanks to Greg Martin, Fruitport, Michigan for the good info he sent. A few years ago Greg had the super experience of visiting Radio Botswana, Radio Tanzania and Zambia TV. Greg's wondering about a strange letter he got from North Korea, which wasn't a QSL or a mailing from Radio Pyongyang. We've run into several of these over the last few months, Greg, and no one can quite figure what to make of them. Best advice is not to respond at all.

Della Malva in Orleans, Massachusetts wonders about the current status of Radiobras (Brazil) and Vatican Radio's English broadcasts to North America. They're both still active, although Radiobras has moved to a mor-

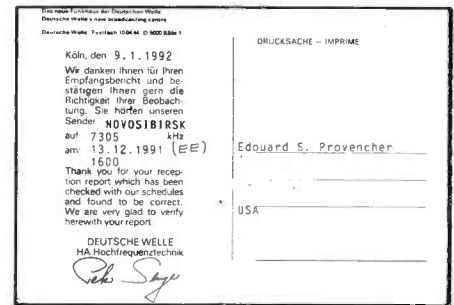

Edouard S. Provencher, Biddeford, Maine, got Deutsche Welle to QSL of their new Russian relay sites.



A sticker from ORTS, Senegal.

ning schedule. Radio RSA is still on the air with English, though only to Africa (see the log report) and WRNO is still on the air.

Keep those cards and letters coming! Logs should be by country, with some cutting space between each and your last name and state abbreviation after each. We need shack photos and spare QSL's to use as illustrations. Station schedules, literature, your comments and so on are always welcome!

Here are this month's logs. All broadcasts are in English (EE) except where noted otherwise (GG = German, SS = Spanish, AA = Arabic, etc.) All times are UTC.

### SWBC Loggings

**Alaska:** KNLS, 0900 sign on, 9815. (Martin, IA) 1300 sign on, 7355. (Moser, PA)

**Albania:** Radio Tirana, 9480 at 1835 with local music, ID, sign off. (Moser, PA)

**Algeria:** Radio Algiers. 9509 at 1942 in FF; 2000. (Story, TX; Moser, PA)

**Antigua:** Deutsche Welle relay, 6085 at 0135. (Seefeldt, WI) 9545 at 0318. (Moser, PA) 11810 at 0200 in SS. (Cabellero, Mexico)

BBC relay, 15220 at 1306. (Moser, PA)

**Argentina:** RAE, 9690 at 0001 with IS, multi-lingual ID. (Zamora, CA) 11710 with ID at 0200. (Martin, MI) 0929 in JJ. (Lamb, NY)

**Armenia:** Radio Yerevan, 9750 at 0336 with EE

## PICKS UP A WHISPER 50 FEET AWAY!



**NEW! High-power  
miniature transmitter  
on a single chip  
assembles in  
only 5 minutes!**

Simply attach the **VT-75** microtransmitter to any 3V to 12V battery and you can hear every sound in an entire house over 1 mile away! Super-sensitive circuit on a single chip even picks up footsteps from across a large room. Tunable from 80 to 130 MHz. Hear everything on any FM radio or wideband scanner tuned to the "secret" frequency you select. Unlimited uses for security, baby monitor, remote mic, etc. **Not a toy.** The **VT-75** meets many U.S. Gov't Military Specs and with **100mW RF output**, it is the smallest, most powerful miniature transmitter you can buy. Easily assembled even by a youngster in only 5 minutes and performs so well that it is the only miniature transmitter available **anywhere** that comes with a **full unconditional moneyback guarantee!** Dealers welcome. Law Enforcement inquiries invited. **VT-75** microtransmitter chip with miniature microphone, 9V battery connector and instructions - **\$49.98 + \$1.50** S&H or save - buy 2 for **\$45.00** each with free S&H! Call us toll free or send money order, Visa, or Mastercard for immediate shipping by U.S. Mail. COD's add \$4. Personal checks allow 21 days.

**DECO INDUSTRIES**  
BEDFORD HILLS, NY 10507  
**800-759-5553**

The leader in wireless design since 1976

CIRCLE 32 ON READER SERVICE CARD

## COMMUNICATION AT ITS BEST

AR900 \$239; AR1000XC \$399;  
AR2500 \$469; AR3000 \$969

Guaranteed Lowest Prices on AOR Radios  
We also sell a variety of CBs, Radar  
Detectors, Shortwave Radios, & Accessories

For orders call: **1-800-33 TURBO**  
Free Shipping

### TURBO ELECTRONICS



P.O. Box 8034  
Hicksville, NY 11802-8034  
Questions welcome (516) 938-1946

CIRCLE 51 ON READER SERVICE CARD

## CB RADIO OWNERS!

We specialize in a wide variety of technical information, parts and services for CB radios. 10-Meter and FM conversion kits, repair books, plans, high-performance accessories. Thousands of satisfied customers since 1976! Catalog \$2.

**CBC INTERNATIONAL**  
P.O. BOX 31500PC, PHOENIX, AZ 85046

## Subscribe Now and Save

**1 Year - \$18.97**

**2 Years - \$36.00**

**3 Years - \$53.00**

## CB TRICKS OF THE TRADE I & II

Tricks I and Tricks II, plus a free set of plans for CB Super Modulation.

Special: **\$40.00**

Order each book separately for \$19.95

C.O.D. Orders Accepted

Medicine Man CB  
P.O. Box 37  
Clarksville, AR 72830  
(501) 754-2076



CIRCLE 27 ON READER SERVICE CARD

### Abbreviation Used In Listening Post

AA	Arabic
BC	Broadcasting
CC	Chinese
EE	English
FF	French
GG	German
ID	Identification
IS	Interval Signal
JJ	Japanese
mx	Music
NA	North America
nx	News
OM	Male
pgm	Program
PP	Portuguese
RR	Russian
rx	Religion/iou
SA	South America/n
SS	Spanish
UTC	Coordinated Universal Time (ex-GMT)
v	Frequency varies
w/	With
WX	Weather
YL	Female
//	Parallel frequencies

news (Rocker, NY) 11605//17690 at 0330. (Miller, GA)

**Ascension Island:** BBC relay, 15400 at 2237. (Moser, PA) 21660 at 1529. (Lamb, NY)

**Australia:** Radio Australia, 6020 at 1210, 11720 at 0548. (Carson, OK) 6080 at 1305. 9860//12000//13755//13760 at 1620. (Lamb, NY) 9580 at 1204. (Moser, PA) 9710 with Papua New Guinea service at 0830. (Martin, IA) 11910 at 1755. (Barry, CA) 17795 at 2353. (Zamora, CA) 21740 at 0000. (Cohen, ON) ABC, Brisbane, 4920 at 0840. (Martin, IA) VNG time station, 16000 at 0815. (Lamb, NY)

**Austria:** Radio Austria International, 5945 at 2130. (Gasque, SC) 6015 via Canada at 0530. (Seefeldt, WI) 9875 at 0137. (Jensen, IA) 13730 at 0834. (Moser, PA)

**Bangladesh:** Radio Bangladesh, 15197 at 1240, sub-continental music. (Story, TX) 15200 at 1230 with news. (Moser, PA)

**Belgium:** BRT, 5910//9905 at 2209 with DX news. (Moser, PA) 9855 at 1000 with "Brussels Calling." (Martin, IA) New 9930 at 0030. (Pellician, CT) 15515 at 2200. (Miller, GA) 21810 at 1400 to Africa. (Borsche, Welle)

**Benin:** ORTB, 4870 in FF at 0542, 0603. (Story, TX; Moser, PA)

**Botswana:** Radio Botswana, 3355 at 0412 in SeTswana, US pops. (Lamb, NY) 7255 at 0251 with IS. (Moser, PA)

VOA relay, 7265//11940 at 0249 sign on. Also 15445 at 2010. (Lamb, NY)

**Brazil:** Radiobras on 117445 at 1205. (Martin, IA) Radio Nacional Amazonia, 6180//11780 at 0800 sign on, PP. (Barry, CA)

Radio Cultura do Para, 5045 at 0809 in PP. (Caballero, Mexico)

Radio Educacao Rural, 3385 at 1016 with PPID. (Gasque, SC)

Radio Universo, 9565 at 0720. Quiet music, ID 0731. (Gasque, SC)

Radio Brazil Central, 11815 in PP at 0816 with pops, ID jingles, commercials. (Lamb, NY)

**Bulgaria:** Radio Sofia, 9560 at 1950. (Moser, PA) 9595 at 0025. (Rocker, NY) 11720 at 0455 and 11765 at 0602. (Carson, OK)

**Burma:** Voice of Mynamar, 4725, tentative, in Asian language at 1048. (Story, TX)

**Cameroon:** CRTV, Garoua, 5010 at 0500 with news. (Story, TX)

CRTV Yaounde, 4850 at 2050; 2121. (Martin, MI; Moser, PA)

**Canada:** CBC Northern Service, 9625 at 1300. (Borsch, IL)

CFCF, Montreal, 6005 at 0630 with discussion. (Story, TX)

CHU time station, 3330, 0155, EE/FF. (Tucker, GA) CFRX/CFRB, 6070 at 1255. (Tucker, GA)

CHNX, Halifax, 6130 at 1000 with news, maritime forecast. (Story, TX)

RCI, 9755 at 0220. (Gruber, FL): 15150 at 1219. (Vaage, CA) 11940 in SS at 0000 and 13650 in SS at 2028. (Cabellero, Mexico) 17820 at 2158 to Africa, off 2159. (Zamora, CA)

**Central African Republic:** Radio Centrafricaine, 5034 at 0542 in FF. (Story, TX)

**Chad:** Rdf. Tchadienne, 4904.5 in FF at 0444. (Story, TX) Tentative, at 0530. (Gasque, SC)

**Chile:** Radio Nacional, 15140 in SS at 1905. Tentative. (Moser, PA)

**China:** Radio Beijing, in RR to 1056 close on 5145. (Gasque, SC) 9690 (via Spain) at 0325. (Scheurell, PA) 0300 with news. (Pellician, CT) 9770//11715 (both via Mali) at 0010. (Zamora, CA) 13685 at 0219 in SS. (Lamb, NY) 15170 at 2119. (Moser, PA)

CPBS, 5880 at 1427 with English lessons. (Zamora, CA) 9455 at 1212 with talk in CC. (Lamb, NY)

**Colombia:** Radio Nacional, 11822 at 0115 in SS. (Caballero, Mexico) 0145, Colombian folk music. (Barry, CA)

Caracol, 6150, 0815 in SS. (Barry, CA) 0340. (Moser, PA)

**Costa Rica:** Radio Reloj, 4832 with IDs, time and notices in SS at 0609. (Zamora, CA) 6005 in SS at 0833. (Caballero, Mexico)

Radio For Peace Int'l, 7375 (AM) at 0545 and 21465 USB at 0140. (Carson, OK) 15030 at 2309. (Jensen, IA)

Adventist World Radio, 9725 at 0207 in SS. (Scheurell, PA) 11870 at 0001 with ID, news. (Zamora, CA)

**Cuba:** 9620 (new) at 2212. (Rocker, NY) 11930 at 0232. (Carson, OK) 11950 at 0430. (Seefeldt, WI) 13700 (new) 0323. (Lamb, NY) 17705 at 2000. "Radio Havana Cuba, where third world countries still come first." (Zamora, CA)

Radio Rebelde, 3366 in SS at 0445. (Carson, OK) 5025 at 0100, SS ID, lively Cuban music. (Zamora, CA)

**Cyprus:** BBC relay, 15575 at 1435. (Tucker, GA)

**Czechoslovakia:** Radio Czechoslovakia (new name) 5930 at 0310. (Carson, OK) 7345 at 2358 with IS, news, modern music. (Tucker, GA) 9505 at 0750. (Lamb, NY)

**Ecuador:** Radio Nacional Progreso, 5061.9 in SS, mostly talk over background music. "Radio Progreso" ID 0225. (Gasque, SC)

Law Voz del Upano, 5040 at 0100 in SS. News, ID. (Scheurell, PA)

Radio Quito, 4920 at 1135 in SS, mentioning stations on the Ecuadorian network. (Gasque, SC)

HCJB, 3220 domestic service in SS at 0827. (Lamb, NY) 9745 at 0058. (Gruber, FL) 11925 at 1351. (Zamora, CA) 11960 at 0030 in SS. (Caballero, Mexico) 15155 at 0100. (Seefeldt, WI) 15270 at 1953. (Carson, OK) 17890 at 1201. (Moser, PA)

**Egypt:** Radio Cairo, 9475 at 0208. (Story, TX) 9900 at 2141. (Moser, PA)

**England:** BBC, 5975 (Antigua) at 0130. (Rocker, NY) 7325 at 2349. (Cohen, ON) 6175 at 0300. (Seefeldt, WI) 9590 at 2100. (Jensen, IA) 9600//9610 at 0402. (Carson, OK) 9915 at 0204. (Gruber, FL) 15220 at 1158. (Moser, PA)

**Ethiopia:** Voice of Ethiopia, 9560 at 1500 with brief news, comment, classical music selection. (Story, TX)

**Finland:** Radio Finland, 9560 at 0236. (Jensen, IA) 0732. (Gasque, SC) 15245//17800 to 0955 in EE, into Finnish. (Stephens, TX) 15400 at 1430. (Martin, IA) 21550 at 1434. (Lamb, NY)

**French Guiana:** RFO, Cayenne, 5055 in FF at 0625. (Story, TX)

**Gabon:** Africa Number One, 4890 at 0430 in FF. (Pellician, CT) 9580 in FF at 1940 with soccer. (Tucker, GA)

**Georgia:** Radio Georgia, 12050 at 0408, woman in unidentified language. (Moser, PA) 12070 at 0609 in RR. (Rocker, NY)

**Germany:** Deutsche Welle, 5545 at 0303 (feeder? editor) 9565 at 0120. (Jensen, IA) 6100 at 0400 in GG and 11765 at 0615 in EE. (Carson, OK) 6120 at 0515. (Vaage, CA) 6145 at 0100. (Pellician, CT) 1865 at 0050 and 15205 at 1050. (Labelle, PQ) 15185 at 0635. (Rocker, NY)

Bayerischer Rundfunk, 6085 at 0112 in GG. ID, continuous pops. DW in EE on top. (Scheurell, PA)

**Ghana:** GBC, 6130 at 0656. (Moser, PA)

**Greece:** Voice of Greece, 9395 at 0127 in Greek, //9420//11645. (Tucker, GA) 9425 at 2339. (Labelle, PQ) 17525 at 1535. (Martin, IA)

Radio Stathmos Makedonias, 11595 at 0625 with Greek Orthodox religious service. Listed for 0600 sign on Sundays, 1000 other days. (Lamb, NY)

VOA relay, 7205 at 0248. (Gruber, FL)

**Guam:** KTWR, 11650 at 1539 with religious program, 1554 ID. (Zamora, CA) 11805 at 0900 sign on, mailbag. (Lamb, NY)

**KSDA**, 11980 at 1613, religious music. (Story, TX)  
**Guatemala**: Radio Cultural, 3300 with religious program 0234. (Story, TX) 0418 in EE/SS. (Carson, OK)  
 Radio K'ekchi, 1135 in SS with folk music, ID's. Also 0235 with religious music to sign off at 0305. (Lamb, NY)  
**Hawaii**: WVVH time signals, 10000 at 0500. (Seefeldt, WI)  
**Honduras**: La Voz Evangelica, 4820, SS religion at 0400. (Pellicciari, CT)  
**Hungary**: Radio Budapest, 9835 at 0315, DX program. (Rocker, NY) 11910 at 0333, interview, DX news, music to 0358 close. (Tucker, GA)  
**Iceland**: INBS, 9265 at 0120, Icelandic. (Rocker, NY) 13855 at 2317 in Icelandic to sign off at 2334. (Moser, PA)  
**India**: All India Radio, 11620 at 1915; 2108; 2200. (Pellicciari, CT; Moser, PA; Miller, GA)  
**Indonesia**: Radio Republik Indonesia, Ujung Padang, 4753.3, Gamelan/karek music at 1015 tune. (Gasque, SC) 1100 in II. (Story, TX)  
**Iran**: VOIRI, 9022 at 0030 with ID, Koran, prayers, commentary on news items. (Tucker, GA) 15085, domestic first program relay at 1928 in Farsi. (Lamb, NY)  
**Iraq**: Radio Iraq International, 11830 at 0034.3—EE ID's "This is Baghdad Radio Iraq International." AA music, news in EE. (Hunter, PA)  
**Israel**: Kol Israel, 9435 at 2004. (Moser, PA) 11588 at 0500. (Rocker, NY) 15640 at 1430 with news. (Tucker, GA)  
**Italy**: Adventist World Radio (via Sines, Portugal) 9605 in Italian with religious talk. Covered by WYFR 0755. Sundays only. (Lamb, NY)  
 European Christian Radio, 6210 at 0659 in EE with ID, address, "Rhyme and Reason" program. Into II at 0718, GG 0733 then all three repeated. Multi-lingual on Sundays only. (Lamb, NY)  
 RAI, 9575 at 0142 with sign on and ID it II to Latin America. (Zamora, CA) 11800 at 0100. (Pellicciari, CT)  
 RAI, 9575 at 0142 with sign on and ID it II to Latin America. (Zamora, CA) 11800 at 0100. (Pellicciari, CT)  
**Japan**: Radio Japan, 5960 (via Canada) at 0353; 15325 (via French Guiana? editor) 0300. (Jensen, IA) 9685 (via French Guiana) 2249 in JJ. 11735 via Gabon, in JJ at 2250. 11815 in JJ at 2248. (Moser, PA) 11870 at 0535. (Rocker, NY) 17810 at 2159. (Zamora, CA) 15345 via Sri Lanka at 1700; 21635 in JJ at 0001. (Cohen, ON) 17890 at 0758 end of EE to Australia, into JJ. (Lamb, NY)  
 Radio Tanpa, 3925 in JJ with play at 0826. (Gasque, SC)  
**Jordan**: Radio Jordan, 9560 at 1700 with news, Amman weather. (Story, TX) 2159 in AA. (Lamb, NY)  
**Kiribati**: Radio Kiribati, 14917.5 (SSB) at 0620, very poor. (Story, TX)  
 Radio Kuwait active again! 15505 at 1817 in AA with news, IDs, local and fusion music, many mentions of Kuwait. (Lamb, NY)  
**Lebanon**: Wings of Hope, 11530 at 2012 "A House of Prayer For All Nations," ID and address. (Martin, MI)  
**Liberia**: ELBC, tentative, 7275 at 0705 with mentions of Monrovia. (Martin, IA)  
**Libya**: Radio Jamahiriyah, 15235 in AA at 0325. Music and presume Koran recitations. (Story, TX)  
**Lithuania**: Radio Vilnius, 7400//17690 at 0010. (Rocker, NY) 9710 at 0025. (Moser, PA) 17605 at 0000. (Barry, CA)  
**Luxembourg**: Radio Luxembourg, 6090 at 0758 in GG. (Rocker, NY) 15350 at 2100 EE news and "Dance Party with Tony Adams." (Miller, GA)  
**Madagascar**: Radio Netherlands relay, 13700 at 1456. (Moser, PA)  
**Malaysia**: Radio Malaysia, Sarawak, 4950 at 1500 with ID, time, orchestra music. (Zamora, CA) 1143. (Story, TX)  
**Mali**: Radiodiffusion du Mali, 4783 at 0620 in FF; 0625 on 5995. (Story, TX) 11960 at 0855 in FF. (Lamb, NY)  
**Malta**: Voice of the Mediterranean, 9765 at 0600 with IDm program lineup over Miller's "In the Mood." Into AA 0650. (Martin, MI)  
 Deutsche Welle relay, 9565 at 0108. (Moser, PA) 11915 in GG at 0105. (Lamb, NY)  
**Mauritania**: Radiodiffusion Mauritanie, 4845 at 2320 with AA chants. Tentative. (Moser, PA) 0630 in AA. (Pellicciari, CT)  
**Mexico**: Radio Educacion, 6185 at 0630 in SS. Music and poetry. (Barry, CA)  
**Monaco**: RT Marocaine, 15105 at 2105 in AA with mideast music. (Moser, PA)  
 VOA Tangier relay, 6110 at 0623. (Lamb, NY)

**Namibia**: Radio Namibia, tentative 3270//3290 in EE with weather for Namibian interior, ID as "NBC." (Martin, IA) 3290 at 0420 with "Dateline Namibia." (Moser, PA)  
**Netherlands**: Radio Netherlands, 6020 at 0031. (Moser, PA) 13700 at 2048 and 13770 at 1454. (Carson, OK) 11720 at 0348. (Jensen, IA)  
 Trans World Radio, 9535//11930 at 0320. (Carson, OK)  
**New Zealand**: Radio New Zealand Int'l, 9700 at 1156. (Moser, PA)  
**Niger**: Radiodiffusion du Niger, La Voix du Sahel, 5020 at 0545 in FF with Koran. (Story, TX)  
**Nigeria**: Radio Nigeria, Kaduna, 4770, 0530. (Story, TX)  
 Voice of Nigeria, 7255, bells, drum IS, anthem, sign on at 0500. (Lamb, NY) 0650. (Martin, IA)  
**North Korea**: Radio Pyongyang at 1300 at 9325//9345. (Borsch, IL)  
**Northern Marianas**: KHBI, Christian Science Monitor, 9530 at 1411. (Story, TX)  
 KFBS, Saipan, 11650 at 1150, religious programs in RR. (Story, TX)  
**Norway**: Radio Norway Int'l, 9615 at 0200 with EE ID, 11925 with EE ID at 0100. (Vaage, CA) 9645 at 0000, EE ID. (Rocker, NY) 11870 at 1513. Picked up Radio Denmark relay at 1530. (Lamb, NY) 11930 at 2300. (Barry, CA)  
**Pakistan**: Radio Pakistan, 11570 at 1700 with news, comment, local flute music. (Story, TX)  
**Papua New Guinea**: NBC Port Moresby, 4890 in EE at 0830; 1030; 1352 to 1400 sign off. (Martin, IA; Story, TX; Zamora, CA)  
**Paraguay**: Radio Nacional, 9735 at 2342 in SS "Cadena nacional deportiva" with soccer—Brazil vs. Peru. (Scheurell, PA)  
**Peru**: Radio Cora, 4915 at 1045 in SS with IDs, presumed news, folks music, animal sounds. (Lamb, NY)  
**Philippines**: FEBC, 9850 at 1315 in CC. (Northrup, MO) 11685 at 0937 with news, ID, Christian pops. (Lamb, NY) 11995 at 1353 with "Computer Corner" and news. (Martin, MI) 1556 ID and program preview, off 1601. (Zamora, CA)  
 Radio Veritas Asia, 11710 sign on at 2300 with ID, into Indonesian. (Caballero, Mexico)  
 VOA relay, 6110//15425 at 1221. (Moser, PA) 17820 after RCI goes off at 2200. (Zamora, CA)  
**Poland**: Radio Polania, 6135//7270 at 0655 in EE with "Postbag." (Lamb, NY) 7270 with news at 0632. (Rocker, NY)  
**Portugal**: Radio Portugal, 9555 at 0253, 9600 at 0243. (Labelle, PQ) 9570//9705 at 0249 with mailbag. Address as Rua Sao Marcal 1, Lisbon. (Zamora, CA) 9635 at 2251 in PP with ID, sports. (Scheurell, PA) 1840 at 0230 sign on in EE. (Moser, PA)  
**Qatar**: Qatar Broadcasting Service, 21555 in AA at 1600 with ID. (Story, TX)  
**Romania**: Radio Romania Int'l, 5990 at 1948 with talk, ID. (Lamb, NY) 6155 at 0207. (Labelle, PQ) 9570 at 0220. (Scheurell, PQ) 11790 at 1410, tentative. (Northrup, MO)  
**Russia**: Radio Moscow, 6000 (Cuba) at 1226, 7115 at 0130, 12050 at 0538 and 21480 at 2315. (Carson, OK) 6945 (Cuba) at 0357, 17770 at 2333. (Jensen, IA) 6060 at 2250. (Seguin, MI) 7260//7345 at 1615. (Zamora, CA) 9180USB feeder at 0805 in RR, 17670//17790 at 1421. (Rocker, NY) 9685 at 0009, 11980 at 2139 and 15375 at 0800. (Labelle, PQ) 11840 (Cuba) at 1701. (Moser, PA)  
 Bashkir Radio, 4485, tentative in RR at 0800. (Martin, IA)  
 Radio Rossii, 9800//11990//15255 at 0650 in RR with ID, organ music, possible anthem, news. (Lamb, NY)  
**Rwanda**: Deutsche Welle relay, 7225 at 0406 with news. (Moser, PA)  
**Saudi Arabia**: BSKSA, 9720 at 1600 with news, ID in EE/AA, off at 1700. (Story, TX)  
**Senegal**: ORTS, 4890 with anthem 0556, news at 0600, in FF. (Gasque, SC) 0630 news in FF. (Pellicciari, CT)  
**Seychelles**: BBC Indian Ocean relay, 15430 at 1315. (Moser, PA) 0401. (Lamb, NY)  
 FEBA, 15200 at 0315 in Farsi with religion, address in Iran, ID, IS and 15325 at 0418 in AA with presumed religious program, ID, IS. (Lamb, NY)  
**Singapore**: Radio One/Singapore Broadcasting Corp, 1407 with news, ID 1409. (Gasque, SC)  
 BBC Far Eastern relay, 9740 at 1157. (Moser, PA)

# NOW YOU'RE TALKING!

## The Code-Free Ham License is Here

Enjoy all Amateur Radio privileges above 30 MHz without having to pass a code test. All you have to do is pass a 55-question exam on basic radio and the FCC regulations. ARRL's new book, **Now You're Talking** makes understanding what is required on the test a snap! And there are exams given all over the country every weekend.



Just think how much fun you'll have communicating through repeaters, enjoy Sporadic E skip and worldwide communications on six meters when conditions are right. There's satellite communication and you can even talk to Astronauts and Cosmonauts in orbit. Enjoy friendly local communication both direct and through repeaters. Help with disaster drills and the real thing! Sound like fun? It is! Order your copy of **Now You're Talking** below: Enclosed is \$19 plus \$4 for shipping (a total of \$23) or charge \$23 to my ( ) VISA ( ) Mastercard ( ) Discover ( ) American Express

Signature \_\_\_\_\_  
 Acct. No. \_\_\_\_\_  
 Good from \_\_\_\_\_ Expires \_\_\_\_\_  
 Name \_\_\_\_\_  
 Address \_\_\_\_\_  
 City \_\_\_\_\_ State \_\_\_\_\_ Zip \_\_\_\_\_ PC

THE AMERICAN RADIO RELAY LEAGUE  
 225 MAIN STREET  
 NEWINGTON, CT 06111

CIRCLE 21 ON READER SERVICE CARD

11750 at 1633, 11950 at 0623, 15360 at 0148. (Lamb, NY)

**South Africa:** Radio RSA, 4810 at 0330 with news, 0335 rooster crow and morning news program in Afrikaans. (Zamora, CA) 7270//11900 at 0400. (Martin, IA) 9550 at 1500, IS. (Story, TX) 11900 at 0400 sign on. (Carson, OK) 11920 at 0300 in FF. (Barry, CA) 15230 at 0401. (Tucker, GA) 15365 at 0255. (Jensen, IA)

Radio Orion, 4810 at 2300, old pops and standards, ID 2330. (Tucker, GA)

**South Korea:** Radio Korea, 5975 at 1600 with sign on, ID, frequency schedule. (Zamora, CA) 9750 at 1243, off at 1259. (Tucker, GA)

**Spain:** Spanish National Radio, 6055 at 0400, 9530 at 0500. (Barry, CA) 9530 at 0015, 0400. (Rocker, NY; Carson, OK) 11880 at 0052. (Labelle, PQ)

Radio Beijing relay, at 0300 with IS, ID, news. (Tucker, GA)

**Sri Lanka:** SLBC on 9720 at 1700, newscast. (Moser, PA)

**Sudan:** National Unity Radio, presumed, 9535 at 1500 with ID, news, "peace message," Arabic Press Review. Usually off at 1529 but sometimes as early as 1519. (Martin, MI)

**Swaziland:** Trans World Radio, 5965 at 0457 with religion. (Moser, PA) 9520 at 1633 with religion in EE and vernaculars. (Story, TX) 9655 at 0408 in unidentified lan-

guage, EE ID at 0430. (Tucker, GA)

**Sweden:** Radio Sweden, 11705 at 0140 in SS, into FF at 0145. (Caballero, Mexico) 0210 in EE. (Moser, PA) 17740//21570 at 1342 and 17870//21500 at 1536. (Martin, IA)

**Switzerland:** Swiss Radio Int'l, 6135 at 0520. (Labelle, PQ) 9650 at 0217. (Jensen, IA) 9885 at 0213. (Carson, OK) 12035 in SS at 0030. (Caballero, Mexico) 13685//21530 at 1553, into FF at 1600. (Zamora, CA) 17730 (via Brazil) at 0206. (Moser, PA) 17830//21695 at 1350. (Martin, IA)

**Syria:** Radio Damascus, 12085 at 2005. (Martin, IA) 15095 at 2110 with frequencies, ID, news. (Moser, PA)

**Turkey:** Voice of Turkey, 11827 in FF at 0440. (Carson, OK) 0918. (Martin, IA) 15171 in FF at 0233 with rock, news. Drum IS and into Tahitian at 0302. (Lamb, NY)

**Taiwan:** Broadcasting Corp. of China, via WYFR 5950//15400 at 2258 in CC. ID and IS are different from VOFC. 11885 at 1501 with relay of local FM 1 program. (Lamb, NY) (Try and get 'em to QSL that, Marie!)

Voice of Free China (direct-not via WYFR) 11745 at 1257 in CC with pops, IS, ID, anthem. (Lamb, NY)

Voice of Asia, 7445 at 1100, definite ID, into EE news. (Story, TX)

**Thailand:** Radio Thailand, 9655 at 1220 with Thai music, heavy QRM. Tentative. (Moser, PA)

**Turkey:** Voice of Turkey, 9445//9460 at 2357. (Labelle, PQ) 9445 2307-0000. (Scheurell, PA)

**Tunisia:** RTV Tunisienne, 7475 and 12005 at 0400. (Cohen, ON) 11550 at 0553. (Story, TX)

**Ukraine:** Radio Kiev, 4825//7400//17690 at 0100 with IS, sign on, frequencies, news. (Moser, PA) 5960//7380 at 2158 with IS, ID, news. (Lamb, NY) 9800 at 1315, unidentified language. (Northrup, MO) 9860 at 0141. (Jensen, IA)

**United Arab Emirates:** UAE Radio, Dubai, 7215 at 2350. (Moser, PA) 11945//13675//15400 at 0221 in AA with IS, ID, anthem, chants. (Lamb, NY) 21605 at 1332. (Martin, IA) 21560 at 1330 with news. (Story, TX)

Voice of the UAE, Abu Dhabi, 9605 at 2325, ID, news and features. (Carson, OK) 11965 at 1815. (Labelle, PQ) 2330. (Story, TX)

**United States:** Radio Free Croatia, via WHRI, 7315 at 0131, EE and Croat. (Gasque, SC)

Croatian Radio Zagreb, relay by WHRI, 7315 at 0000 to 0015. (Barry, CA)

WMLK, 9465 at 0644 with Elder Meyer. (Carson, OK) KGEI, 15280 in SS at 0310, ID "LA Voz de la amistad." (Scheurell, PA)

KTBN, 15590 at 1750. (Tucker, GA)

Radio Marti, SS 9590 at 1246. (Tucker, GA) 11930 at 1400 sign on in SS. (Zamora, CA)

La Voz de la OEA, 11830 in SS at 2345. (Tucker, GA)

WWCR, 7345 with Radio Miami International at 0056. (Lamb, NY)

**Uzbekistan:** Radio Tashkent, at 1330 on 5945//9540//15470//17745. (Martin, IA) 9540 at 1330. (Borsch, IL)

**Vatican:** Vatican Radio, 5885 in SS at 2010. (Gasque, SC) 6095 at 0246. (Labelle, PQ) 6245 at 0610. (Rocker, NY) 7305 in SS at 0355. (Caballero, Mexico) 9695 at 0630 with African service in EE. (Moser, PA) 11625 to Africa at 0650 to 0658 close. (Lamb, NY) 15090 at 2003. (Cohen, ON) 15090//17865 at 1545 sign on to sub-continent and southeast Asia. Off 1600. (Zamora, CA)

**Venezuela:** Radio Rumbos, 4970 at 0310 in SS. (Story, TX) 9660 at 0159 in SS. (Carson, OK)

Radio Continental, 4940 at 0530 in SS, Latin music. (unib reporter)

Radio Nacional, 9540 with EE news at 1140. (Martin, IA) 1139 in EE with rock, ID, sked, address, IS. Into FF at 1145. (Lamb, NY)

Ecos del Torbes, 4980 in SS at 0127 with tangos. (Scheurell, PA)

**Vietnam:** Voice of Vietnam, 9840 at 1027; 1230. (Story, TX; Borsch, IL) 15010 at 1848 in FF. (Lamb, NY)

**Yemen:** Republic of Yemen Radio, 7190 at 0300 with anthem, man in AA. (Moser, PA) 9779 at 2050 in AA. (Story, TX)

**Yugoslavia:** Radio Yugoslavia, 9505 at 2210 with movie reviews. (Rocker, NY) 9580 at 0130 sign on. (Carson, OK) 15140 at 1939 with news. (Lamb, NY) 17740 at 1245 with Yugo rock groups. Now ID'ing as Radio Federal Yugoslavia. (Tucker, GA)

That's the story for this time. A big thank you and tip 'o the hat to the following reporters this month:

Daryl E. Rocker, Frankfort, NY; Marie Lamb, Brewerton, NY; William Moser, New Cumberland, PA; Christian Labelle, St. Jerome, Quebec; Steve Pellicciari, Norwalk, CT; Paul Jensen, Mason City, IA; Larry R. Zamora, Highland, CA; Barry T. Stephens, Austin, TX; Kevin Story, Midland, TX; Greg Martin, Fruitport, MI; Bjorn F. Vaage, Granada Hills, CA; Mike Martin, Monroe, IA; Andreas A. Scheurell, Pittsburg, PA; Darran Gruber, Palm City, FL; Bernadine Seguin, Muskegan, MI; John Carson, Jr., Norman, OK; Patrick J. Barry, Mission Viejo, CA; Murray Cohen, Fonthill, Ontario; Todd Borsch, Princeton, IL; Manuel Fernando Caballero S., Monterrey, Mexico; Jeff Seefeldt, Wausau, WI; David A. Gasque, Orangeburg, SC; Stephen R. Hunter, Philadelphia, PA.

Thanks to all and, until next month, good listening!

## R7000

(from page 30)

photo 3) Output to the cathode end of previously installed Da; input to R72's right lead (closest to front of receiver). R72 is located slightly above and to the left of Da.

Now install the delay board using a M3-20 screw (I bought this item at a local hardware store) and a 1/2" spacer in the upper middle mounting hole. Be careful that the leads on the bottom of the delay board do not touch any components on the main board. It may be wise to use an insulator between these boards. I used a thin, sturdy card stock I had on hand. You may have to improvise at this point and your local hobby shop may have something usable.

## Testing

You will probably want to try your project

out before closing the receiver up. If so, be careful. Set the Delay switch to the "off" position and the Scan Start/Stop switch to whatever your pleasure is. For testing purposes an antenna isn't needed. Just start the receiver scanning and then turn the squelch control CCW to "off"—the scanning will stop as if a signal were received. Now turn the Squelch control until receiver goes quiet. Scanning should not start until the time selected with Ct has passed. If problems are encountered, check all wiring carefully. Assuming you have no problems, the covers may now be re-installed after unplugging the power cord! Remember to reconnect the speaker connector before replacing the top cover.

Now sit back and enjoy "real" scanning operation with the R-7000.

## Satellite View

(from page 35)

in the former USSR. In fact you may recall that in the November 91 issue I gave you a profile of the Moscow satellite control station RS3A and the new satellite that was to have been launched this year. It would appear that the military control of the station may have ended. The DOSAAF as it was called is no longer funding the launch of the satellites and may no longer have complete control of RS3A. The staff has dwindled from over two dozen to eight souls. There is only one satellite control operator on staff now. So the search is on for a way to get the latest RS off the ground. I also mentioned that Leo Labutin (UA3CR) was connected with DOSAAF. Well, I was wrong. He has, however, worked closely with them in the past.

Gee, that's two errors this decade, I must be getting old.

There is one other thing I have been wanting to tell you for some time. If your main interest is Amateur Radio Satellites I suggest you contact AMSAT-UK. They publish the most complete and interesting bulletin on both Amateur (international) Satellites and the Mir space station. The bulletin called *Oscar News* is well worth the membership, and you will be supporting the Amateur Space Program in the process. Write: AMSAT-UK, Secretary R. J. C. Broadbent, 94 Herongate Rd., Wanstead Park, London E12-5EQ, UK. Or call 081-989-6741 or FAX (24 hours) 081-989-3430. Tell them POP'COMM sent you. See you next month.



## Beaming In

(from page 4)

worthless checks written on overdrawn accounts, then wait for the Congressmen to put money in their accounts. None were charged overdraft fees by the bank. Dozens more former members of Congress are still on the bank's books as having incurred overdrafts. Individual accounts had overdrafts totaling as much as \$100,000 to \$700,000. One guy handed out almost 1,000 checks that added up to better than \$500,000. If it were you that had passed hundreds of rubber checks during a 39 month period, where would you be right now (other than in Congress)?

Here's the thing, folks. These are the people making laws about what's right and wrong; telling us how to conduct our daily activities. It makes me wonder about several things in relation to the attention they pay to anti-monitoring anti-scanner laws.

For instance, I almost hesitate to bring up the unpleasant matter concerning the state of our national economy and that the employment rate isn't all that good. Neither is the plight of the poor, the elderly, farmers, the hungry, the homeless, nor the care that our veterans receive. And somehow, I get the general impression that the nation seriously needs effective and immediate Congressional action relating to the drug situation, environmental problems, education, national health, urban decay, restoring Native American

rights, governmental waste, the S&L scandal, the balance of trade, and reducing the national debt, to name just a few things.

What with the way they handle their own personal finances, how concerned can they possibly be about the national debt? And don't you wonder how really worried the hot check hotshots are about the government's wasteful spending habits? Like the government buying \$15 hammers for \$435, shelling out \$640 for toilet seats, \$7,622 for coffee makers, and a steel nut for \$2,043. The General Accounting Office (GAO), the federal agency that investigates government waste and inefficiency, recently reported that in only six months, the Navy doled out \$9.2-million to repair 7,710 various things that should have, instead, been replaced with new items already purchased for that purpose that have been sitting on shelves in federal supply depots.

Domestic problems either continue in the status quo, or else they grow worse. Yet, it's amazing that members of both houses of Congress feel that they have time enough to spend casually wrestling with pressing dilemmas like which frequency bands scanners should be prohibited from receiving. They had time for dealing with whether old black and white movies may be colorized, and if demonic messages are heard when rock music recordings are played in reverse. Did anybody read in the *Congressional Record* the lengthy dissertations on differences between

Oregon and Wisconsin cheeses? Last March, one House member was talking about introducing a bill to stop the Postal Service from issuing its stamp honoring Elvis Presley. Aren't they able to address anything more significant than this?

Forgive me, but I'm less than impressed with this performance from Senators who earn \$135,000 per year, and Congressmen who earn \$125,000 per year, all of whom also receive numerous perks including cheap medical care and prescriptions, free postage, free first-class air transportation, free offices, free staff members, plus the ability to fix traffic tickets in the District of Columbia.

Somebody ought to hand these people a list of the things going on in the nation, then lock the Senate and House doors and not let them out until they stop playing games and begin doing something actually useful. Which bands scanners should or shouldn't receive would have such a low priority that it wouldn't even be on the agenda. Will scanner manufacturing regulations save as many lives as cigarette manufacturing regulations?

Of course, it's not completely the fault of the members of Congress, even the truly good ones. They're all politicians. As such, they are easily accessed by high pressure professional lobbyists who do the bidding for well heeled interests. Maybe these interests control some campaign contributions, or can influence large blocks of voters. These interests have certain self-serving legislation they want

# ART-1

**ART-1:** A complete interface system for send and receive on CW, RTTY (Baudot & ASCII) and AMTOR, for use with the Commodore 64/128 computer. Operating program on disk included.

**\$199.00**

**AIR-1:** A complete interface system for send and receive on CW, RTTY (Baudot & ASCII) and AMTOR, for use with Commodore VIC-20. Operating program in ROM.

**\$99.95**

# AIR-1

# SWL

**SWL:** A receive only cartridge for CW, RTTY (Baudot & ASCII) for use with Commodore 64/128. Operating program in ROM.

**\$69.95**

**AIRDISK:** An AIR-1 type operating program for use with your interface hardware. Both VIC-20 and C64/128 programs on one disk.

**\$39.95**

# AIRDISK

**AIR-ROM:** Cartridge version of AIRDISK for C64/128 only.

**\$59.95**

# MORSE COACH

**MORSE COACH:** A complete teaching and testing program for learning the Morse code in a cartridge.

For C64 or C128.

**\$49.95**

VEC SPECIAL

**\$39.95**

G AND G ELECTRONICS  
OF MARYLAND

8524 DAKOTA DRIVE, GAITHERSBURG, MD 20877



(301) 258-7373



CIRCLE 17 ON READER SERVICE CARD

# Why buy a TNC?

## PC HF FAX + PC SWL \$179.00

### SPECIAL COMBINATION OFFER

For a limited time, if you order PC HF FAX \$99 (see our other ad in this issue), you can add our new and improved PC SWL 3.0 for \$80.00 instead of our regular low price of \$99.00.

PC SWL contains the hardware, software, instructions and frequency lists needed to allow you to receive a vast variety of digital broadcasts transmitted over shortwave radio. All you need is any IBM PC or compatible computer and an SSB shortwave receiver. The product consists of:

Demodulator  
Digital Signal Processing Software  
200 Page Tutorial Reference Manual  
World wide Utility Frequency List  
Tutorial Audio Cassette with Samples

PC SWL automatically decodes Morse code, Radio Teletype, FEC (forward error correcting code), SELCAL (selective calling transmissions), and NAVTEX.

PC SWL lets you tune in on world press services with up to the minute news, meteorological broadcasts, ham radio operators, coastal shore stations, aviation telex and much more digital action on the shortwave bands. Find all the utility station action you have been missing. PC SWL software uses the processor in your PC to do the work, why pay for another expensive box when a simple interface and your PC can do the job?

#### ADVANCED FEATURES:

- Tuning Oscilloscope
- Digital Waveform Presentations
- Auto Calibration and Code Recognition
- Continuously Tunable Filter Frequencies
- Variable Shift
- Adjustable CW Filter Sensitivity
- Unattended Capture and Printing
- Integrated Text Editor
- Integrated Log and Database
- Shell to DOS applications
- RTTY/NAVTEX Background Operation
- Seamless Integration with PC HF Facsimile

Call or write for our complete catalog of products. Visa & MasterCard welcome.

**Software Systems Consulting**  
615 S. El Camino Real, San Clemente, CA 92672  
Tel: (714) 498-5784 Fax: (714) 498-0568

CIRCLE 18 ON READER SERVICE CARD

pushed through. The primary purpose of such legislation, when stripped bare of its window dressing, is intended to increase the income, clout, or image of the legislation's sponsors. This causes the lawmakers to continue shoving junk laws and drive into the legislative pipeline. It's legal, but unfortunately, fills up much of the House and Senate's available time, clogging it with cost-consuming debates, posturing, speeches, studies, hearings, reports, committee meetings, and votes on absolute piffle that serves no public benefit. It takes away time and attention from other things that need to be accomplished.

The greedy cellular telephone industry already took up several years of Washington's time when they hand-carried their idiotic and useless ECPA through the halls of Congress. You'd think they'd now be satisfied. Not so. And the do-nothing brigade in Washington is now more than willing to again welcome them with open arms. Looks like the cellular industry either doesn't realize or doesn't care that there's anything very important on the national agenda.

There is a great irony to all of this. The fact that the government is willing to go to great extremes and impose harsh penalties to assure privacy to cellular phone calls is, in itself,

preposterous. Uncle Sam can't even keep his own affairs private. There's a booming black market in your confidential personal data stolen by government clerks from the records of the Social Security Administration. The data on citizens is then openly sold to insurance companies, credit services, and private investigators by professional brokers in information. Under the 1974 Privacy Act, it's merely a misdemeanor to peddle this information. A deputy inspector at the Dept. of Health and Human Services said he didn't think additional security laws are needed.

Last winter, the FCC's General Counsel circulated a memo to warn the agency's staff members to stop leaking the FCC's confidential internal memos to the press and others. Similar warning memos have been sent in the past, but without any lasting results.

The GAO is complaining about rampant security lapses within the Drug Enforcement Administration (DEA). This includes unattended computers containing classified information; janitors without security clearance being allowed to work alone in security areas; and classified documents left lying about on desks and in office FAX machines. In one instance, master keys to a DEA office were lost seven years ago, yet the locks were never

changed even after 17 other sets of keys to the doors were reported lost or stolen (some clearly marked "DEA").

But, have no fear! Uncle Sam is working hard to ensure that at least the public's cellular telephone calls will definitely be private! Both houses of Congress have been hard at work on this project since 1984. I'm sure they will keep plugging away at it until they can finally figure out a way to lick the ticklish problem. If they ever get it right, maybe then they'll look into other serious matters that have arisen, like what to do with rock stars who lip synch. And, is pro wrestling fake or real?

This is an election year. It's important that you vote for individuals based on what they have or haven't accomplished. Don't vote on the basis of labels, ethnic or religious considerations, handsome faces, slick TV commercials, or party affiliations. Ask incumbent U.S. Senators and members of the House of Representatives to reveal their thoughts and voting records on the ECPA (1986), and the sections of S. 1132 or H.R. 1674 that related to cellular telephones, equipment, and monitoring. If their answer waffles, or is otherwise unsatisfactory, consider voting for a candidate who is unwilling to give away your rights to private interests. ■

## NEW FROM THE UNITED KINGDOM

### LOWE HF 150

At last! A high quality receiver at an affordable price. This Little Giant will hold its own against those Big Guys, some costing twice as much. Simplicity makes the HF 150 easy to operate. Superb audio enhances the HF 150's performance. State of the art features offer: Synchro Detection, 60 programmable memories, Pre-Amp for whip antenna and optional Keyboard entry. Don't let the size fool you. This truly is "Real Radio".

## GATEWAY TO THE WORLD

### LOWE HF 225

SAME HIGH QUALITY CONSTRUCTION AND RECEPTION RATED 4 STARS BY PASSPORT'S LARRY MAGNE. MANY FEATURES OF THE HIGHER COST RADIOS.

- \*FREQUENCY 30kHz - 30 MHz
- \*MULTI MODE, AM, SSB, CW
- \*OPTIONAL AM SYNCHRO & FM
- \*30 MEMORY CHANNELS
- \*FILTERS FOR ALL MODES
- \*OPTIONAL KEY BOARD
- \*BUILT-IN SPEAKER, EXT. SPEAKER, REC. JACKS
- \*10-15VDC .15A (.3A MAX) AC/NICADS OPT.
- \*PASSPORT WHITE PAPER AVAILABLE. #RD19 FOR \$5.50

- OPTIONS OFFERED:
- \*KEYBOARD
  - \*NICAD PACK
  - \*ACTIVE ANTENNA
  - \*SYNCHRO DETECTION
  - \*AC ADAPTER

**HF 225 INTRODUCTORY PRICE \$749.95.**

HF 235 ALSO AVAILABLE, CALL FOR PRICING!



## NOW SOLD & SERVICED BY EEB



- \*FREQUENCY 30kHz - 30MHz
- \*MULTI MODE, AM, AMN, LSB, USB
- \*AM SYNCHRO, ASU, ASL, ASF, ASD
- \*BANDWIDTH 7kHz & 2.5kHz
- \*TUNING STEP A FINE 8Hz
- \*OPTIONAL KEYBOARD
- \*60 MEMORIES (FREQ. & MODE)
- \*3 ANT INPUT 600 BAL 50 OHM COAX HI Z (WHIP)
- \*BUILT IN SPEAKER, EXT. JACK & RECORD OUT
- \*POWER 10-15VDC .15A (.3A MAX) 8AA OPT.
- \*CASE, ALL METAL LIGHT ALLOY
- \*SIZE 7.3"W x 3.2"H x 6.3"D WEIGHT 2.9 LBS.
- \*OPTIONS:
- \*120V ADAPTER
- \*TELESCOPE WHIP
- \*KEYPAD ENTRY
- \*CARRYING STRAP
- \*BABY RUTH® INCLUDED

**HF150 INTRO PRICE \$599.95 (LIST\$699)**  
CALL, FAX OR WRITE FOR DETAILED FLYER!



**ELECTRONIC EQUIPMENT BANK, INC**  
**800-368-3270**

FAX 703-938-6911 / TECH 703-938-3350  
323 MILL ST. N.E. VIENNA, VA 22180

# 1992 POPULAR COMMUNICATIONS COMMUNICATIONS GUIDES

## WINTER

The Winter Communications Guide is the most up-to-date buyer's guide for communications equipment—from communications receivers and scanners, to CB radio and amateur transceivers!

Complete with articles by experts in the communications field, including Dexter, Kneitel, Helms, Gysi, Orr, Zeller, Margolis and many more, the Winter Communications Guide is the book you've been waiting for—Here's what's inside:

An introduction to the fascinating world of communications monitoring with: illustrated articles on scanning, utility monitoring, antenna selection and construction, pirate radio, QSLing and much MORE!

AS AN ADDED BONUS, noted ham Fred Maia, W5YI tells just how easy it is to get your HAM LICENSE. In plain English, Maia explains ham radio and how YOU can become a licensed ham. In addition, a product listing with PHOTOS of amateur radio transceivers for use by Technician class licensed hams is included.

The Winter Communications Guide includes the latest communications products on the market with detailed specifications and photos to make your buying decision easier. We've included short-wave receivers, scanners (BOTH base and handheld) and accessories to make your monitoring post complete.



INCLUDES many features, designed

- To help you understand mobile monitoring laws, in the United States AND Canada.
- To explain the ins, and outs of using your RADAR DETECTOR and how police radar works.
- To help you properly install your detector.
- To help you learn the ropes of using your CELLULAR PHONE while on the road.
- To let you hear all the SPORTS action wherever you are.

For amateur radio operators, there's also a list of the most common 2-meter repeater frequencies. Best of all, we've arranged everything in a quick, easy-to-find format—Just look up the state, province or territory and you'll find that page packed with information, frequencies, traffic information and much more!



## SUMMER

An all-new travel guide available in June!

It's coming, just in time for your summer vacation! LOADED with hundreds of festivals, rodeos, air shows, regattas, and outdoor concerts, this is THE book you need before you make any vacations plans.

ORDER BOTH TODAY BY PHONE, FAX OR MAIL!

Please send me: \_\_\_\_\_ copies of the Winter Communications Guide  
 \_\_\_\_\_ copies of the Summer Communications Guide

For a total of \_\_\_\_\_ copies at \$4.95 each plus \$2.50 shipping & handling (\$3.50 foreign) for first Guide ordered and \$1.00 for each additional Guide.

Mail to: CQ Communications, Inc., 76 North Broadway, Hicksville, NY 11801, Phone: 516-681-2922/FAX: 516-681-2926

Name \_\_\_\_\_

Address \_\_\_\_\_

City \_\_\_\_\_ State \_\_\_\_\_ Zip \_\_\_\_\_

Check  Money Order  MasterCard  VISA  Amex

Card No. \_\_\_\_\_ Expires \_\_\_\_\_

Signature \_\_\_\_\_ (required on all charge orders)

# COMMUNICATIONS SHOP

**Advertising Rates:** POP/COMM subscribers are entitled to one FREE 30-word, non-commercial classified ad per year. Enclose subscription name label with ad copy. For those people not in the previously mentioned group, non-commercial ads are 30 cents per word, including abbreviations and addresses; minimum charge \$6.00 per issue. Ads from firms offering commercial products or services are \$1.00 per word; minimum charge \$20.00 per issue. Boldface words are \$1.20 each (specify which words). Leading key words set in all caps at no additional charge. All ads must be prepaid in full at time of insertion; a 5% discount is offered for prepaid 6 time insertions. All ads must be typewritten double spaced.

**Approval:** All ad copy is subject to Publisher's approval and may be modified to eliminate references to equipment and practices which are either illegal or otherwise not within the spirit or coverage scope of the magazine.

**Closing Date:** The 10th day in the third month preceding date of publication. Because the advertisers and equipment contained in Communications Shop have not been investigated, the Publisher of Popular Communications cannot vouch for the merchandise listed therein. Direct all correspondence and ad copy to: PC Communications Shop, 76 N. Broadway, Hicksville, NY 11801.

**BIG 7th Edition: Top Secret Registry of Government Radio Frequencies**, by Tom Kneitel. Grown to gigantic 240-page! 1000's of new listings, frequencies, stations for all scanner owners, nationwide. Includes: FBI, DEA, Customs, Secret Service, FCC, Immigration, Border Patrol, U.S. Attorney, ATF, Treasury, Fed. Prisons, U.S. Marshal, CIA, Postal Service, NSA, NORAD, USAF, USN, Army, USMC, FAA, NASA, DOE, NRC, FEMA, Dept. Agriculture, National Parks, USCG, EPA, DOT, V.A., UHF aero (225 to 400 MHz) listings, bugs & surveillance freqs, agents' lingo, codes, many more agencies, lots more info! Expanded Canadian listings. Only \$19.95, plus \$3.50 postage to N. American addresses. NY State residents add \$1.88 sales tax. Order now from CRB Research Books, P.O. Box 56, Commack, NY 11725. Dealer Inquiries Invited.

**PAN-COM INTL CATALOG.** Over 350 Kits, Plans, Licensed/unlicensed AM/FM broadcasting, Ham/CB/SW/DX, 1750M transmitters, Surveillance devices, Computers/Software, Science Projects, MORE. Box 130-P07, Paradise, CA 95967.

**NEW RADIO BUFFS SPECIAL.** ALINCO MONTH IS EVERY MONTH AT RADIO BUFFS. CALL FOR ALINCO QUOTES! ALSO BEST PRICE ON ALL TEN-TEC, JRC, AMERITRON, MFJ, B&W, BENCHER, AOR, KLM/MIRAGE, COMET, BUG CATCHER, SPI-RO, HAM STICK, AMECO, SANGANE, DAIWA, OUTBACKER, ASTRON, RAMSEY KITS, ARRL PUBLICATIONS, GEOCHRON CLOCKS, PALOMAR. WE STOCK A COMPLETE LINE OF AMATEUR, SWL, AND MARINE RADIO EQUIPMENT AND SUPPLIES. ORDERS ONLY 1-800-828-6433.

**Directory of U.S. Army Forts, Camps, & Airfields (1789-1945).** A 144 page illustrated book; more than 5,400 listings of named army installations from the Revolutionary War era right to end of WWII, includes Army Air Corps fields. Gives locations. Only \$15.95 plus \$3.50 shipping. NY State residents add \$1.56 sales tax. Order from CRB Research Books, P.O. Box 56, Commack, NY 11725.

**SCANNER FREQUENCY SEARCH SERVICE.** Hear all there is to hear! SASE to: Heald, 6885P Jefferson Street, North Branch, MI 48461.

**NEW 1992 CB IMPORT/EXPORT RADIO CATALOG** - Hard to Find CB Dealers, Equipment, Modification Kits and Plans - \$3.00. **LORD/WYATT COMMUNICATIONS**, P.O. Box 030128PCJ2, BROOKLYN, NY 11203-0001."

**LESCOMM** improved PRO-2006 - \$469.95. Includes: LED S'Meter, squelch improvement, beep volume, SSB connector, 45-CPS, 760-1300MHz, warranty. Lescomm, PO Box 5212, Jacksonville, AR 72076.

**RCI-2950 OWNERS:** New modification manual including Power Increase, Clarifier Modification, Operating Hints, and More. Parts included. Only \$20.00 ppd in U.S. (Mo. residents add \$1.15 tax). Scott, P.O. Box 510408, St. Louis, MO 63151-0408.

**SCANNER ANTENNAS, VERY SENSITIVE.** All Types. Do It Yourself! Easy construction. Book \$10.00. CT Electronics, P.O. Box 6, Woodville, OH 43469.

**SCANNERS, 800 MHZ CONVERTERS.** Adapters For 800 mhz to 950mhz Nothing Blocked Use Any Scanner. **LOWEST PRICES ON UNIDEN BEARCAT SCANNERS,** Antennas, etc. Tell Us What You Want! CT Electronics, P.O. Box 6, Woodville, OH 43469.

**CELLULAR HACKERS BIBLE.** Theory - Hacks - Modifications - \$53.95. **TELECODE**, PO Box 6426-PC, Yuma, AZ 85366-6426.

**CABLE TEST CHIPS** Scientific-Atlanta 8550-321, 8500-310, 311, 320, 321 (specify) - \$33.95 8580-338 - \$69.95, 8570/8590 - \$79.95. ZENITH 2F-1 - \$33.95. STARCOM 6 - \$33.95. STARCOM 7 - \$49.95. TOCOM 5503/07VIP - \$33.95. **TELECODE**, PO Box 6426-PC, Yuma, AZ 85366-6426.

**KENWOOD & ICOM** Service Bulletins. 175+ pages covering all models - \$39.95. Catalog - \$3.00. **CODS** 602-782-2316/FAX 602-343-2141. **TELECODE**, Box 6426-PC, Yuma, AZ 85366-6426.

**VIDEOCIPHER II/Satellite/Scanner/Cable/Amateur/Cellular/Repair Manuals, Modification Books & Software.** Catalog - \$3.00. **TELECODE**, PO Box 6426-PC, Yuma, AZ 85366-6426.

**JOBS** in Electronics. Companies are still hiring for positions in US and Overseas. For a listing of 400 companies plus resume guide, send \$10.00 to Benthos-PC, POB 23336, Barigada, GU, 96921.

**PRO-2004/5/6 OWNERS:** Search-and-Store finds unknown frequencies automatically. Internal no-holes installation - Keyboard control - Wired-tested-postpaid - Ten channel \$24.95 - Selectable to 255 channels \$44.95. US checks or MO. SASE for information. Key Research, POB 846P, Cary, NC 275-0846.

**AM BROADCAST BAND INTERFERENCE??** Reject broadcast band interference from HF and VLF bands with a precision filter from NCL. Provides 40 + db rejection. Write or call for FREE tech sheet. **NORTHWEST COMMUNICATIONS LABORATORIES**, Dept PC, 813 SW Highland, Suite 310C, Redmond, OR 97756. (503) 923-2540.

**CODEMAN TEACHES MORSE CODE THE EASY WAY!** This IBM PC program makes learning the code a breeze. From 1 to 15 WPM. Includes playing text files, random character generator, character recognition, play keyboard input, and a tutoring function. Program and instruction manual \$15.95 ppd. Specify 3.5 or 5 in. format. Write VAL Enterprise, 4423 Woodstock Dr. #4B, W.P. Beach, FL 33409.

"THE RCI HANDBOOK": RCI2950/RCI2900/Sommerkamp 789/Galaxy Uranus, \$20, "The Uniden Cookbook" \$20, "Uniden Updates" (supplements) \$12: HR2600/HR2510/HR2830/Lincoln/HTX-100. Coming soon: AR3300/AR3500 book. Inquiries: SASE! Money orders: Bud, KC4GHG, POB 907, Satsuma, AL 36572.

**SHORTWAVE PARADISE BBS** now has the new summer schedules available. Call our computer line now at 1:305-524-1035. We are a FREE! BBS computer system.

**WORLD MAP DIRECTORY.** There you are at 2am about to sign off when all of a sudden a signal comes skipping in from Radio Free Tonga. The WMD will not only help you locate Tonga, it will tell you where you can get maps for Tonga or anywhere else in the world. Call MapLink: (805) 965-4402.

**TOMCAT'S BIG CB HANDBOOK**, by Tom Kneitel. Just published, 221 large pages, fully illustrated. Complete guide to worldwide AM, SSB, Freeband, 27 MHz operations. Everything they never told you (legal & otherwise) from world's leading CB authority. Only \$13.95 (plus \$3.50 postage to North America) from CRB Research Books, Inc., P.O. Box 56, Commack, NY 11725. (NY residents add \$1.40 sales tax). Dealer inquiries invited.

**Absolute** best HR2510/2600 mods ever published. Expert technician's mods for more power, frequency shifting, cw, packet, broadbanding and much more. Satisfaction guaranteed. Send \$15 US for complete manual or \$2 for info to: Total Radio Service, 1355 Kingston Rd., Box 83-110, Pickering, Ontario, Canada L1V 1B8.

**BIG AIR-SCAN 5TH EDITION** by Tom Kneitel. Complete guide to aero comms. Now in gigantic 192-page large-size format containing 60,000 + listings, including 2-30 MHz HF, 118 to 174 MHz VHF, 406 to 512 MHz UHF, and 800 MHz listings. Covers civil, military, private, and unlisted landing areas, heliports, and seaplane bases. Control towers, ground, approach/departure, FSS, unicoms, multicomms, crop dusters, air-ambulances, federal ops. traffic copters, aviation business, airline enroute, airport security/fire, etc. throughout USA. All Canadian mil, civilian airports and seaplane bases listed, plus lots more, including how-to text on aero monitoring. Most comprehensive aero frequency guide ever compiled. Only \$14.95 + \$3.50 postage to USA/Canada/APO/FPO. NY State residents add \$1.48 sales tax. From: CRB Research Books, Inc., P.O. Box 56, Commack, NY 11725, or ask your favorite communications dealer.

**COMMODORE 64 HAM PROGRAMS** - 8 disk sides over 200 Ham programs - \$16.95. 29c stamp gets unusual software catalog of Utilities, Games, Adult and British Disks. Home-Spun Software, Box 1064-PC, Estero, FL 33928.

**TUNE In On Telephone Calls.** Tom Kneitel's new 160-page book. Everything you need to know to effectively use a scanner and communications receiver to eavesdrop on private telephone calls from homes, offices, cars, ships, aircraft, trains. Explanatory text, photos, extensive listings section covers USA/Canada on HF, VHF, UHF, and above; thousands of locations, frequency assignments. Explains equipment, best techniques, laws regarding monitoring cellular, cordless, ship/shore, high seas, Air Force 1, airliners, 1-way paging, more. Only \$12.95 (plus \$3.50 postage to USA/Canada/APO/FPO) from CRB Research. Box 56, Commack, NY 11725. NY residents add \$1.32 sales tax. Dealer inquiries invited.

**WOW! UNDERSTANDING & REPAIRING CB RADIOS** by Lou Franklin. **Giant 380-page technical book picks up where THE "SCREWDRIVER EXPERTS" GUIDE leaves off. Includes circuit descriptions and troubleshooting guide for virtually all CB radios: 23 and 40-channel, crystal and PLL, solid-state and tube, AM, FM, SSB, CW, American, British and export models. Covers test equipment, transistor basics, synthesizers, receivers, transmitters, power supplies, T/R switching, antennas, interference, parts and accessory sources. Over 350 illustrations plus huge subject index. Moneyback Guarantee! Only \$29.95 plus \$3.50 U.S. & Canadian Air Mail, VISA/MC accepted. Free catalog of unique CB books, plans, and modification kits with order. Catalog only, \$2. **CBC INTERNATIONAL INC., BOX 31500PC, Phoenix, AZ 85046.** Thousands of satisfied customers since 1976.**

**RADIO MONITORS NEWSLETTER OF MARYLAND FOR THE SERIOUS SHORTWAVE AND SCANNER LISTENERS.** PO Box 394, Hampstead, MD 21074. For a one year subscription: \$15.00. Sample copy: one dollar.

**Radio New York International!** Listen for us every Sunday night at 9 pm (Eastern), 8 pm (Central), 6 pm (Pacific) over WWCR, 7435 kHz. All of your favorites: Al Weiner, Steve Cole, Pirate Joe, John P. Lightning, & more! Live call-in at 800-326-2859. QSL's (send SASE) from RNI, 14 Prospect Ave., Yonkers, NY 10705. Spend your Sunday nights with RNI!

**SCANNER MODIFICATION HANDBOOK VOL.1** by Bill Cheek ("Doctor Rigormortis"). New 160-page book. More than 20 performance improvement modifications. Simple step-by-step instructions, many photos. Primarily PRO-2004 & PRO-2005, some for PRO-3A, BC-200/205XLT, BC-705XLT, BC-705XLT. Restore blocked out bands, speed up scanning rate, disable "beep," increase number of channels, improve squelch action, add an S-meter, interface with shortwave receivers, etc. Make the PRO-2004 & 2005 into a 6,400 channel scanner; put 3,200 channels into the PRO-3A! Plus, cellular frequency charts, antenna info & mods, inside info on frequency management, operating hints, emergency power supplies, scanners & the law, lots more! Only \$17.95, plus \$3.50 shipping to addresses in USA/Canada. Residents of NY State add \$1.72 tax. **Big 220 page VOL.2** with 18 more mods for PRO-2004/5/6, PRO-3A, PRO-2022, BC-760/950XL, BC-200/205XL, now available, \$17.95 plus \$3.50 shipping. NY state residents include \$1.72 tax. If both books ordered at the same time, send only \$4.50 shipping. Order from CRB Research Books, Inc., PO Box 56, Commack, NY 11725.

**TONE-CALL TONE ALERTING SYSTEM** for CB, Ham, Scanners. Radio stays silent until called. **No Modifications, Inexpensive!** Write: Rob Bellville, Box 892PC, Northboro, MA 01532.

**DEVICE INTPRETS CELLULAR DATA** transmissions (voice and control). Follow frequency changes and much more. Send business size SASE: CCS, PO Box 11191, Milwaukee, WI 53211.

**BULGARIAN RADIO AMATEUR (LZ1BB)** seeks help in obtaining an inexpensive or donated SSB Citizens Band (CB) transceiver. Write H.D. Popov, "Bratya Bakston," Blok 207 A, A-6, 1618 Sofia, Bulgaria.

**Special Offer!** 7th Top Secret Federal Frequency Registry. \$18.99 postage paid. Wyatt Industries, POB 1305, Arroyo Grande, CA 93421, (805) 925-3102, check/money order.

**THE NEW YORK MONITOR NEWSLETTER**—a monthly Newsletter that provides CB'ers with the latest up-to-the-minute Technical information—Radio Repair and Modification—Phase Lock Loop (PLL) Circuit/Expander—**2 YEAR COURSE IN ELECTRONIC COMMUNICATION** and much more!! \$24 per year mail to **LORD/WYATT COMMUNICATIONS, P.O. Box 030128PCD, Brooklyn, NY 11203-0001.**

**CW? NO PROBLEM.** You can increase your speed, no matter how many times you've failed before. **Results guaranteed** when you follow the instructions. **PASS Publishing's CW Mental-Block Buster** program helps you **explode mental blocks** that hold you back. Based on 40 years of research, the **CW Mental-Block Buster** uses guided meditation, dynamic visualizations, and powerful affirmations to blast through mental blocks. **You can do code!** That means new bands, more contacts, more fun! (This is not a CW practice tape.) The **CW Mental-Block Buster** audio cassette and practice booklet are only \$25.95 ppd. in the US (NY residents add \$2.08 sales tax). (Quantity discounts available for classes.) **PASS Publishing, P.O. Box 570, Stony Brook, NY 11790. VISA, MC, COD: 516-584-8164. FAX: 516-584-9409.**

**MORSE code got you down?** Why let a mental block stand between you and upgrading? Use **PASS Publishing's CW Mental-Block Buster** to **blast through those barriers.** Just follow the instructions for 30 days—**Results Guaranteed!** Based on 40 years of research, the **CW Mental-Block Buster** uses guided meditation, dynamic visualizations, and powerful affirmations to blast through mental blocks. **You can do code!** That means new bands, more contacts, more fun! (This is not a CW practice tape.) The **CW Mental-Block Buster** audio cassette and practice booklet are only \$25.95 ppd. in the US (NY residents add \$2.08 sales tax). (Quantity discounts available for classes.) **PASS Publishing, P.O. Box 570, Stony Brook, NY 11790. VISA, MC, COD: 516-584-8164. FAX: 516-584-9409.**

**CW Lite** is the **easiest** Morse code training method in the world, bar none! And it is the **fastest**, too. Just close your eyes and relax. This powerful **hypnosis cassette tape** does the rest. **Subliminals** speed you along! Only \$15.95 ppd in US (NY residents add \$1.28 tax). Order today! **PASS Publishing, Box 570, Stony Brook, NY 11790. VISA, MC, COD: 516-584-8164. FAX: 516-584-9409.**

**WORLD'S MOST UNUSUAL** Communications Books! A large selection of outstanding titles covering scanners, "confidential" frequency registries, bugging, wire tapping, electronic surveillance, covert communications, computers, espionage, monitoring, and more! New titles being added constantly! Ask for our big **FREE** catalog. **CRB Research, Box 56-PC, Commack, NY 11725.**

**SATELLITE** and cable descrambling. Build your own descramblers. Surveillance and countermeasures. Build your own transmitters, detectors. How to modify your scanner. Eavesdrop for fun manual. Send stamp for free catalog to: **Communications Engineering, 76 Boulevard, Hudson Falls, NY 12839.**

**KNOW** The Secret of the Lights! **NEW LED S-Meter** chart for radios with signal lights. Lets you read all signal light meters. 100% accuracy. Send \$22.00 certified check to: **Thomas Scalfaro, 4622 James St., East Syracuse, New York 13057.**

**SURVEILLANCE TRANSMITTER KITS** tune from 65 to 305 MHz. Mains powered duplex, telephone, room, combination telephone/room. Catalog with **Popular Communications, Popular Electronics and Radio-Electronics** book reviews of "Electronic Eavesdropping Equipment Design," \$2.00. **SHEFFIELD ELECTRONICS, P.O. Box 377785, Chicago, IL 60637-7785.**

**AR-1000XLT** with cellular - \$395; **AR-2800** with cellular - \$449; **AR-2500** with cellular - \$465; **AR-3000** with cellular - \$959; **BC-200XLT** - \$249; **BC-760XLT** - \$279; **BC-855XLT** - \$209; **RCI-2950** 10 mtr mobile - \$289; **RCI-2990** base, call!! Kenwood, Yaesu, Icom, Bearcat, more!! Free UPS shipping to 48 states. We ship C.O.D. daily. Buy/sell/trade new and used gear. Price sheets \$125. **Galaxy, Box 1202, Akron, OH 44309, (216) 376-2402 EST. Our 10th Year!!**

**UHF MOBILE RADIO** YAESU model FTL-7002, 25 watts, 12 channel synthesized with CTCSS and scanning. Unused - \$350. (215) 693-68805

**UHF REPEATER** YAESU model FTR-5410, 10 watts, less duplexer, unused with manual - \$600. (215) 693-6805.

**SCANNER REPAIR** Bearcat-Regency-Realistic. \$38 flat-rate covers parts, labor & shipping. Programmable models only. Send scanner & check or MO to: **RADIO ONE, 4168 Baker St. Ext., Lakewood, NY 14750. Ph. 716-763-9104.**

**SCANNERS** CBs, Antennas, Marine, 2way, accessories, Handy-Talkies. Write for free brochure. **HPR, Box 19224C, Denver, CO 80219.**

**FAX THIS!** Our scanner & shortwave catalog prints out on your fax machine! "Poll" us 24 hours a day at (212) 989-6158. Or call our voice line at (212) 989-5773. **Firecom, PO Box 61-PC, New York, NY 10011.**

**Satellite-TV** 100% Satisfaction Guarantee **FREE 56 page Catalog**  
**SAVE 40% - 60%**  
**All Major Brands, Systems, Upgrades, Components & Accessories**  
**Huge Savings, Easy Installation and Complete Instructions** 800-334-6455  
**SKYVISION INC. 218-739-5231 Int'l**  
 1066 FRONTIER DRIVE  
 FERGUS FALLS, MN 56537  
**INSTALL OR UPDATE YOURSELF!**

**New Sony ICF-2010/2001D Filter Mods**

- Wideband and Narrowband filter replacements dramatically improves selectivity
- A must for SSB and shortwave DX'ing
- Easy to install - Complete instructions are included

**Here the difference - Maximize performance**  
**Kiwa Electronics, 612 South 14th Ave. Yakima WA 98902 Tel: 509-453-KIWA**

**CIRCLE 36 ON READER SERVICE CARD**

**PAY TV AND SATELLITE DESCRAMBLING**  
**ALL NEW 1992 EDITION ALL NEW**

1992 edition update on cable, wireless and satellite. Turn-ons, circuits, bullets, bags, B-Mac backscapers. Includes new VC plus fixes. Our best yet. Only \$15.95. Other (all different) editions: volume one (basics), 1989 edition, 1991 edition, \$15.95 each. **MDS Handbook \$9.95.** Satellite systems under \$600. \$12.95. Any 3/29.95 or 5/549.95. Scrambling News Year One (154 pages) \$39.95. Video \$29.95. Scrambling News Monthly \$24.95/yr. Sample \$3. New catalog \$1. **Special this month everything listed for \$99.95.**

**Scrambling News, 1552P Hertel Ave. Buffalo, NY 14216. Voice/FAX (716)-874-2088. COD'S ARE OK. ADD \$6.**

P. E. A. R. L., announces **PEARLFEST '92** the yearly HamFest for the Putnam Emergency and Amateur Repeater League. It is to be held July 25, 1992 from 8am to 2pm in Brewster, NY at the JFK Elementary School. Admission is \$4.00/person. Prize drawings throughout the day, food, free parking and more! Talk-in frequency KG10/R 145.130 MHz down 600.

**SCANNER/HAM RADIO MODIFICATION HANDBOOKS; FREQUENCY DIRECTORIES - UNIDEN, AERONAUTICAL, GOVERNMENT, MILITARY** books by CRB, TAB, GROVE, ARRL, others. GRE products. Phone orders VISA/MC, CATALOG \$1.00 (refundable) **DOYLE COMMUNICATIONS-DPC, Route 8, Box 18, Lake Pleasant, NY 12108. (518) 548-5515.**

**TOUCH-TONE DECODER** Decode those tones you've heard on your telephone or scanner! The HB-16 Decoder decodes, stores, and displays touch-tone (DTMF) digits directly from your scanner, tape, recorder, or telephone line. Decode dialed numbers received on cordless, cellular! Plans, PC board and all IC's for only \$29.95! Send SASE for more information. **HB Technologies, POB 2771-P, Spring Valley, CA 91979.**

**SHOCKING MANUALS!!** Survival Electronics, Computers, Telephones, Energy, Weapons, Financial, Medical. 100+ Plus Special Projects, Technical Research Services. Confidentiality Guaranteed! Send \$3 for catalogs. By John Williams, (CBS "60 MINUTES" fame). Since 1971. **CONSUMERTRONICS, 2011 Crescent Dr., P.O. Drawer 537, Alamogordo, NM 88310.**

Make a Thing . . . Make a Living . . . Study **Industrial Design Technology** and bring your ideas to life. Learn to problem-solve, sketch, render and design. Develop models, create prosthetic appliances. Build your future in movie and theater special effects, toy and product, exhibit, transportation, furniture/fixture, architectural and amusement environment design at **The Art Institute of Fort Lauderdale, Pittsburgh, Seattle or The Colorado Institute of Art.** For information write: 526 Penn Avenue, Dept. 59, Pittsburgh, PA 15222 or call **1-800-525-1000.**

**COMMUNICATION AT ITS BEST** AR-1000XC \$399, AR-2500 \$469, AR-3000 \$969, ATS803A \$195. We sell a variety of CB's, Scanners, Radar Detectors, Caller ID's and more. **Free Shipping.** VISA/MC/Diners Turbo Electronics, PO Box 8034, Hicksville, NY 11802. Questions and Catalogs: (516) 938-1946. Orders 1-800-337URBO.

**MANUFACTURER'S CLOSE-OUT** - Limited quantity brand new dynamic base station microphones Japanese manufactured "gooseneck" type 500 ohm. Pre-wired 4 or 5 pin \$42.00 each. All sales final. (206) 727-3225.

**CABLE TV CONVERTERS**  
**Why Pay A High Monthly Fee? Save \$100's A Year**

- All Jerrold, Oak, Hamilton, Zenith, Scientific Atlanta, and more.
- VISA/MC and C.O.D.
- 60 Day Money Back Guarantee
- Shipment within 24 hours

**WE WILL BEAT ANYONE'S PRICE**  
 No Illinois Orders Accepted

Purchaser agrees to comply with all state and federal laws regarding private ownership of cable TV equipment. Consult local cable operator

**Electronic Engineering**  
 P.O. Box 337, Barrington, IL 60011  
**Free catalog 1-800-542-9425 Information 1-708-540-1106**

**SHOCKING MANUALS!!**

Survival Electronics, Computers, Security, Weaponry, Rock-etry, Phones, Energy, Financial, Medical. 100+ offers include **Special Projects and Technical Research Services, and hardware. Confidentiality Guaranteed! Send \$4 for new Combined Catalog.** By John Williams, former Senior Engineer (Lockheed), Professor of Computer Science (NMSU). As seen on CBS "60 Minutes." Since 1971.

**SECRET & SURVIVAL RADIO:** Comprehensive, detailed manual on the optimum freqs, equipment, modes and circuits for secret, survival and security situations. Includes small transmitters and receivers; ultrasonic, infrared and fiberoptic commo, improvising and optimizing antennas. 70+ circuit diagrams. \$29.

**TV DECODERS & CONVERTERS:** Detailed plans for several do-it-yourself hacker-designed TV decoders, descramblers, converters and related devices (cable and satellite). Lists sources. Many tips. \$14.

**CELLULAR PHONE MANUAL:** Comprehensive, detailed manual on how cellular phones are re-programmed (ESNs and NAMS) and scanned. 30+ cellular phone mods described. Specific scanner mods. \$39.

Many more! **STEALTH TECHNOLOGY (\$19), PHONE COLOR BOXES (\$29), VOICE MAIL BOX HACKING (\$29), COMPUTER PHREAKING (\$39), BEYOND VAN BOX PHREAKING (\$29), STOPPING POWER METERS (\$19), RADIOICONS MANUAL (\$29), EM BRAINBLASTER (\$29), HIGH VOLTAGE DEVICES (\$29), DISK SERVICE MANUAL (\$29), ATMs (\$39)**

**SOLD FOR EDUCATIONAL PURPOSES ONLY.** Include \$4 for ship/handl.

**CONSUMERTRONICS**  
 2011 CRESCENT DR., P.O. DRAWER 537  
 ALAMOGORDO, NM 88310 (505)-434-0234

**CIRCLE 35 ON READER SERVICE CARD**

**Advertiser's Index**

AMC Sales, Inc.	45
ARRL	73
Ace Communications, IN	80, Cov. III
Advanced Electronic Applications	5
Antenna Specialists	6
Antenna Supermarket	59
Antique Radio Classified	61
Barry Electronics Corp.	63
CB City International, Inc.	72
C. E. T., Inc.	52
CRB Research	63, 72
Cellular Security Group	18
Consumertronics	79
DECO	72
Datametrics, Inc.	60
Delta Research	23
Drake, R.L. Company	7
EDE	63
Electronic Engineering	79
Electron Processing	45
Electronic Equipment Bank	176
G & G Electronics	75
GRE America, Inc.	49
Gilfer Shortwave	4
Ham Radio Bookstore	70
ICOM America, Inc.	Cov II, 39
ISECO, Inc.	53
Ivie Technologies, Inc.	53
J & J Enterprises	63
JPS Communications, Inc.	31
Japan Radio Company, Ltd.	21
Jo Gunn Enterprises	28
Kenwood USA Corporation	Cov. IV
Kiwa Electronics	79
Lentini Communications, Inc.	39
MFJ Enterprises, Inc.	13
Medicine Man CB	72
MoTron Electronics	61
National Amateur Radio Assoc.	4
OFS WeatherFAX	20
OPTOelectronics	15, 19
POP COMM Communications Guide	77
RF Limited	18
React International	33
Sangean America, Inc.	11
Scanner World USA	8
Scrambling News	79
Signal Engineering	53
Skyvision, Inc.	79
Software Systems Consulting	70, 75
Systems & Software Int'l, Ltd.	52
Turbo Electronics	72
Universal Radio, Inc.	3
Viking International	39
Wilson Antenna, Inc.	23
Xandi Electronics	63

**Reach this dynamic audience with your advertising message, contact Don Allen, N9ALK at (217) 344-8653, FAX 217-344-8656.**

# AOR Scanners.

**Great Performance. Great Service. Great Value.**

**Free Freight**  
**25-Day Money-Back Guarantee**  
**Toll-Free Service and Support**  
**No Credit Card Surcharge**  
**One Year Warranty**



**NEW!**  
**EXTENDED**  
**COVERAGE!**

**AR1000**

**\$429**

**1000 Channels. 500KHz to 1300MHz**

**Standard Features:**

- Extremely compact size.
- Continuous coverage.
- Antenna attenuator switch, 10db.
- Manual tuning knob.
- Earphone jack, 3.5mm.
- AM, FM and wide band FM tuning modes.
- Backlighted LCD display.
- 10 Scan Banks, 10 Search Banks.
- Selectable Priority Channel.
- Delay, Hold Features.
- Selectable Search Increments, 5-955KHz.
- Permanent memory backup.
- 4 AA Ni Cad batteries included.
- AC adaptor/charger.
- Carry Case.
- Cigarette Lighter Charger.
- Belt Clip.
- Earphone.

**Options:**

External Speaker. Mobile Mount. MS190 \$19.50  
Extended Warranty. 2/3 yrs \$45/\$55

**Specifications:**

Coverage: 500KHz-1300MHz  
Sensitivity: .35uV NFM, 1.0uV WFM, 1.0AM  
Speed: 20 ch/sec. scan. 40 ch/sec. search  
IF: 561.225, 58.075, 455KHz or 10.7MHz  
Increments: 5 to 955KHz selectable/ 5 or 12.5 steps.  
Audio: .4 Watts  
Power: Input 9 - 13.8 V. DC  
Antenna: BNC  
Display: LCD  
Dimensions: 6 7/8H x 1 3/4D x 2 1/2W. 12oz wt.

**AR950/AR900**

**\$289/\$229**



**100 Channels. Low, Air, High, UHF & 800MHz.**

**Standard Features:**

- Extremely compact size.
- Unrestricted 800MHz coverage.
- 100 channels permanent memory.
- Earphone Jack.
- Delay, Hold features.
- Channel 1 Priority.
- 5 Scan Banks, 5 Search Banks.
- Two antennas included.
- AC & DC Power cord w/mobile mnt. hrdwr. (AR950)
- NiCad battery w/chgr adapter. (AR900)
- One Year Limited Warranty.

**Options:**

Base type antenna	
25 to 1000MHz w 50'coax.	AS300 \$59.95
Mag Mnt Mobile Antenna. 15' coax.	MA100 \$25.00
Cigarette Lighter power adaptor.	CP100 \$5.00
Wide band preamp	GW-2 \$89.00
Extended Warranty. 2/3 yrs	\$40/\$55

**Specifications:**

Coverage: 27-54, 108-174, 406-512, 830-950MHz  
Sensitivity: .4uV Lo,Hi. .8uV Air. .5uV  
UHF. 1.0uV 800  
Scan Speed: 15 ch/sec.  
IF: 21.4MHz, 455KHz  
Increments: 10,12.5,25,30  
Audio: 1W  
Power: 12.8VDC, 200MA  
Antenna: BNC  
Display: LCD w/backlight  
Dimensions: 2 1/4H x 5 5/8W x 6 1/2D. 14oz wt. (AR950)  
5 3/4H x 2W x 1 1/2D. 12oz wt. (AR900)

**We offer 100's of communications products.**

# Unbelievable Price.

**AR2500**

**\$429**



## 2016 Channels. 1 MHz to 1500 MHz

### Standard Features:

- continuous coverage.
- AM, FM, wide band FM, & BFO for SSB, CW.
- 64 Scan Banks.
- 16 Search Banks.
- RS232 port built in.
- Includes AC/DC pwr crd. Antenna, Mntng Brckt.
- One Year Limited Warranty.

### Options:

Earphone.	EP200	\$2.00
External Speaker. Mobile Mount.	MS190	\$19.50
Extended Warranty. 2/3 yrs.		\$65/\$75
Mobile Mounting Bracket.	MM1	\$14.90
RS232 Control Package	SCS2	\$295.00
(software & cable) offers spectrum display and database.		
Wide band preamp	G-W2	\$89.00

### Specifications:

Coverage:	1MHz-1500MHz
Sensitivity:	.35uV NFM, 1.0uV WFM, 1.0AM/SSB/CW
Speed:	38 ch/sec. scan. 38 ch/sec. search
IF:	750.00, 45.0275, 5.5MHz 455KHz
Increments:	5,12,5,25 KHz
Audio:	1.2 Watts at 4 ohms
Power:	Input 13.8 V. DC 300mA
Antenna:	BNC
Display:	LCD, backlighted
Dimensions:	2 1/4H x 5 5/8W x 6 1/2D Wt. 1lb.

**AR3000**

**\$1095**



## 400 Channels. 100KHz to 2036MHz.

### Standard Features:

- Extremely compact size.
- Continuous coverage.
- Attenuation Programmable by Channel.
- Manual tuning knob.
- Tuning increments down to 50Hz.
- AM, FM, wide band FM, LSB, USB, CW modes.
- Backlighted LCD display.
- 4 Scan and Search Banks, Lockout in Search.
- 4 Priority Channels.
- RS232 control through DB25 connector.
- Delay, Hold Features.
- 15 band pass filters, GaAsFET RF amp.
- Sleep and Alarm Features.
- AC adaptor / charger. DC power cord.
- Telescopic Antenna
- One Year Limited Warranty.

### Options:

Earphone.	EP200	\$2.00
External Speaker. Mobile Mount.	MS190	\$19.50
Extended Warranty. 2/3 yrs.		\$65/\$75
Mobile Mounting Bracket.	MM1	\$14.90
RS232 Control Package	SCS3	\$295.00
(software & cable) offers spectrum display and database.		
Wide band preamp	G-W2	\$89.00

### Specifications:

Coverage:	100KHz-2036MHz
Sensitivity:	.35uV NFM, 1.0uV WFM, 1.0AM/SSB/CW
Speed:	20 ch/sec. scan. 20ch/sec. search
IF:	736.23, (352.23) (198.63) 45.0275, 455KHz
Increments:	50Hz and greater
Audio:	1.2 Watts at 4 ohms
Power:	Input 13.8 V. DC 500mA
Antenna:	BNC
Display:	LCD
Dimensions:	3 1/7H x 5 2/5W x 7 7/8D Wt. 2lb 10oz.

## To Order Call 1•800•445•7717

In All 50 States and Canada. 24 Hours a Day. Fax Orders: 1-800-448-1084, 24 Hours a Day.

ACE Communications Monitor Division 10707 E. 106th Street, Fishers, IN 46038

Int'l Voice# 317-842-7115. Int'l Fax# 317-849-8794.

Service and Support Lines: Mon-Fri 9a.m. to 9p.m., Saturday 10-4. EST

MasterCard, Visa, American Express, Checks, Approved P.O.'s. & C.O.D. (add 5.00)

*Prices and specifications subject to change.*

# KENWOOD

## Hear it All!



### R-5000

### R-2000

High performance receivers.

Scan the world bands with Kenwood's R-5000, R-2000 and RZ-1. Listen in on foreign music, news, and commentary. Monitor local police, fire, and other public safety services, as well as the Marine channels, and the many other services.

*(The VHF converter options must be used in the R-5000 and R-2000.)*

### R-5000

The R-5000 is a high performance, top-of-the-line receiver, with 100 memory channels, and direct keyboard or main dial tuning—makes station selection



### R-2000

The R-2000 is a full band, all mode receiver with 10 memory channels, and many deluxe features such as programmable scanning, dual 24-hour clocks with timer, all-mode squelch and noise blankers, a large, front-mounted speaker, 110 volt AC or 12 volt DC operation (with the DCK-1 cable kit), and 118-174 MHz VHF capability with VC-10 option.

### Optional Accessories R-2000:

- VC-10 VHF converter
- DCK-1 DC cable kit for 12 volt DC use.

### R-5000:

- VC-20 VHF converter
- VS-1 Voice module
- DCK-2 for 12 volt DC operation
- YK-88A-1 AM filter
- YK-88SN SSB filter
- YK-88C CW filter
- MB-430 Mounting bracket.

### Other Accessories:

- SP-430 External speaker
- SP-41 Compact mobile speaker
- SP-50B Mobile speaker
- HS-5 Deluxe headphones
- HS-6 Lightweight headphones

KENWOOD U.S.A. CORPORATION  
COMMUNICATIONS & TEST EQUIPMENT GROUP  
P.O. BOX 22745, 2201 E. Dominguez Street  
Long Beach, CA 90801-5745  
KENWOOD ELECTRONICS CANADA INC.  
P.O. BOX 1075, 959 Gana Court  
Mississauga, Ontario, Canada L4T 4C2

# KENWOOD

...pacesetter in Amateur Radio  
CIRCLE NO. 1 ON FREE INFORMATION CARD

### RZ-1 Wide-band scanning receiver



The RZ-1 wide-band, scanning receiver covers 500 kHz-905 MHz, in AM, and narrow or wideband FM. The automatic mode selection function makes listening

super easy! Other useful features include programmable scanning, large, built-in speaker, 110 volt AC or 12 volt DC operation (with optional DCK-2 cable), VHF capability (108-174 MHz) with the VC-20 option, dual 24-hour clocks with timer, and even voice frequency readout with the VS-1 option.

easier. One hundred memory channels with message and band marker, direct keyboard or VFO frequency entry, and versatile scanning functions, such as memory channel and band scan, with four types of scan stop. The RZ-1 is a 12 volt DC operated, compact unit, with built-in speaker, front-mounted phones jack, squelch for narrow FM, illuminated keys, and a "beeper" to confirm keyboard operation.

- Optional Accessory
- PG-2N Extra DC cable

Specifications, features, and prices are subject to change without notice or obligation.